



77 / 79
PEAK ROAD

SALES BROCHURE
售樓說明書

You are advised to take the following steps before purchasing first-hand residential properties.

For all first-hand residential properties

1. Important information

- Make reference to the materials available on the Sales of First-hand Residential Properties Electronic Platform (SRPE) (www.srpe.gov.hk) on the first-hand residential property market.
- Study the information on the website designated by the vendor for the development, including the sales brochure, price lists, documents containing the sales arrangements, and the register of transactions of a development.
- Sales brochure for a development will be made available to the general public at least 7 days immediately before a date of sale while price list and sales arrangements will be made available at least 3 days immediately before the date of sale.
- Information on transactions can be found on the register of transactions on the website designated by the vendor for the development and the SRPE.

2. Fees, mortgage loan and property price

- Calculate the total expenses of the purchase, such as solicitors' fees, mortgage charges, insurance fees and stamp duties.
- Check with banks to find out if you will be able to obtain the needed mortgage loan, select the appropriate payment method and calculate the amount of the mortgage loan to ensure it is within your repayment ability.
- Check recent transaction prices of comparable properties for comparison.
- Check with the vendor or the estate agent the estimated management fee, the amount of management fee payable in advance (if any), special fund payable (if any), the amount of reimbursement of the deposits for water, electricity and gas (if any), and/or the amount of debris removal fee (if any) you have to pay to the vendor or the manager of the development.

3. Price list, payment terms and other financial incentives

- Vendors may not offer to sell all the residential properties that are covered in a price list. To know which residential properties the vendors may offer to sell, pay attention to the sales arrangements which will be announced by the vendors at least 3 days before the relevant residential properties are offered to be sold.
- Pay attention to the terms of payment as set out in a price list. If there are discounts on the price, gift, or any financial advantage or benefit to be made available in connection with the purchase of the residential properties, such information will also be set out in the price list.

- If you intend to opt for any mortgage loan plans offered by financial institutions specified by the vendor, before entering into a preliminary agreement for sale and purchase (PASP), you must study the details of various mortgage loan plans¹ as set out in the price list concerned. If you have any questions about these mortgage loan plans, you should check with the financial institutions concerned direct before entering into a PASP.

4. Property area and its surroundings

- Pay attention to the area information in the sales brochure and price list, and price per square foot/ metre in the price list. According to the Residential Properties (First-hand Sales) Ordinance (Cap. 621) (the Ordinance), vendors can only present the area and price per square foot and per square metre of a residential property using saleable area. Saleable area, in relation to a residential property, means the floor area of the residential property, and includes the floor area of every one of the following to the extent that it forms part of the residential property - (i) a balcony; (ii) a utility platform; and (iii) a verandah. The saleable area excludes the area of the following which forms part of the residential property - air-conditioning plant room; bay window; cockloft; flat roof; garden; parking space; roof; stairhood; terrace and yard.
- Floor plans of all residential properties in the development have to be shown in the sales brochure. In a sales brochure, floor plans of residential properties in the development must state the external and internal dimensions of each residential property². The external and internal dimensions of residential properties as provided in the sales brochure exclude plaster and finishes. You are advised to note this if you want to buy furniture before handing over of the residential property.
- Visit the development site and get to know the surroundings of the property (including transportation and community facilities). Check town planning proposals and decisions which may affect the property. Take a look at the location plan, aerial photograph, outline zoning plan and cross-section plan that are provided in the sales brochure.

¹ The details of various mortgage loan plans include the requirements for mortgagors on minimum income level, the loan limit under the first mortgage and second mortgage, the maximum loan repayment period, the change of mortgage interest rate throughout the entire repayment period, and the payment of administrative fees.

² According to section 10(2)(d) in Part 1 of Schedule 1 to the Ordinance, each of the floor plans of the residential properties in the development in the sales brochure must state the following—
 (i) the external dimensions of each residential property;
 (ii) the internal dimensions of each residential property;
 (iii) the thickness of the internal partitions of each residential property;
 (iv) the external dimensions of individual compartments in each residential property.

According to section 10(3) in Part 1 of Schedule 1 to the Ordinance, if any information required by section 10(2)(d) in Part 1 of Schedule 1 to the Ordinance is provided in the approved building plans for the development, a floor plan must state the information as so provided.

5. Sales brochure

- Ensure that the sales brochure obtained is the latest version. According to the Ordinance, the sales brochure made available to the public should be printed or examined, or examined and revised within the previous 3 months.
- In respect of an uncompleted development, the vendor may alter the building plans (if any) whenever the vendor considers necessary. To know the latest information of an uncompleted development, keep paying attention to any revised sales brochures made available by the vendor.
- Read through the sales brochure and in particular, check the following information in the sales brochure -
 - whether there is a section on “relevant information” in the sales brochure, under which information on any matter that is known to the vendor but is not known to the general public, and is likely to materially affect the enjoyment of a residential property will be set out. Please note that information contained in a document that has been registered with the Land Registry will not be regarded as “relevant information”;
 - the cross-section plan showing a cross-section of the building in relation to every street adjacent to the building, and the level of every such street in relation to a known datum and to the level of the lowest residential floor of the building. This will help you visualize the difference in height between the lowest residential floor of a building and the street level, regardless of how that lowest residential floor is named;
 - interior and exterior fittings and finishes and appliances;
 - the basis on which management fees are shared;
 - whether individual owners have obligations or need to share the expenses for managing, operating and maintaining the public open space or public facilities inside or outside the development, and the location of the public open space or public facilities; and
 - whether individual owners have responsibility to maintain slopes.

6. Government land grant and deed of mutual covenant (DMC)

- Read the Government land grant and the DMC (or the draft DMC). Information such as ownership of the rooftop and external walls can be found in the DMC. The vendor will provide copies of the Government land grant and the DMC (or the draft DMC) at the place where the sale is to take place for free inspection by prospective purchasers.

- Check the Government land grant on whether individual owners are liable to pay Government rent.
- Check the DMC on whether animals can be kept in the residential property.

7. Information on Availability of Residential Properties for Selection at Sales Office

- Check with the vendor which residential properties are available for selection. If a “consumption table” is displayed by the vendor at the sales office, you may check from the table information on the progress of sale on a date of sale, including which residential properties are offered for sale at the beginning of that date of sale and which of them have been selected and sold during that date of sale.
- Do not believe in rumours about the sales condition of the development and enter into a PASP rashly.

8. Register of Transactions

- Pay attention to the register of transactions for a development. A vendor must, within 24 hours after entering into a PASP with a purchaser, enter transaction information of the PASP in the register of transactions. The vendor must, within 1 working day after entering into an agreement for sale and purchase (ASP), enter transaction information of the ASP in the register of transactions. Check the register of transactions for the concerned development to learn more about the sales condition of the development.
- Never take the number of registrations of intent or cashier orders a vendor has received for the purpose of registration as an indicator of the sales volume of a development. The register of transactions for a development is the most reliable source of information from which members of the public can grasp the daily sales condition of the development.

9. Agreement for sale and purchase

- Ensure that the PASP and ASP include the mandatory provisions as required by the Ordinance.
- Pay attention that fittings, finishes and appliances to be included in the sale and purchase of the property are inserted in the PASP and ASP.
- Pay attention to the area plan annexed to the ASP which shows the total area which the vendor is selling to you. The total area which the vendor is selling to you is normally greater than the saleable area of the property.
- Pay attention to the vendor’s right to alter the building plans (if any) for an uncompleted development. The mandatory provisions to be incorporated in an ASP for uncompleted development as required by the Ordinance include a provision requiring the vendor to notify the purchaser in writing of such alteration if the same affects in any way the property within 14 days after its having been approved by the Building Authority.

- A preliminary deposit of **5%** of the purchase price is payable by you to the owner (i.e. the seller) on entering into a PASP.
- If you do not execute the ASP within **5 working days** (working day means a day that is not a general holiday or a Saturday or a Black rainstorm warning day or gale warning day) after entering into the PASP, the PASP is terminated, the preliminary deposit (i.e. 5% of the purchase price) is forfeited, and the owner (i.e. the seller) does not have any further claim against you for not executing the ASP.
- If you execute the ASP within 5 working days after the signing of the PASP, the owner (i.e. the seller) must execute the ASP within 8 working days after entering into the PASP.
- The deposit should be made payable to the solicitors' firm responsible for stakeholding purchasers' payments for the property.
- find out whether any commission is payable by you to the estate agent and, if so, its amount and the time of payment; and
- note that only licensed estate agents or salespersons may accept your appointment. If in doubt, you should request the estate agent or salesperson to produce his/her Estate Agent Card, or check the Licence List on the Estate Agents Authority website: www.eaa.org.hk.

12. Appointment of solicitor

- Consider appointing your own solicitor to protect your interests. If the solicitor also acts for the vendor, he/she may not be able to protect your best interests in the event of a conflict of interest.
- Compare the charges of different solicitors.

For first-hand uncompleted residential properties

10. Expression of intent of purchasing a residential property

- Note that vendors (including their authorized representative(s)) should not seek or accept any specific or general expression of intent of purchasing any residential property before the relevant price lists for such properties are made available to the public. You therefore should not make such an offer to the vendors or their authorized representative(s).
- Note that vendors (including their authorized representative(s)) should not seek or accept any specific expression of intent of purchasing a particular residential property before the sale of the property has commenced. You therefore should not make such an offer to the vendors or their authorized representative(s).

11. Appointment of estate agent

- Note that if the vendor has appointed one or more than one estate agents to act in the sale of any specified residential property in the development, the price list for the development must set out the name of all the estate agents so appointed as at the date of printing of the price list.
- You may appoint any estate agent (not necessarily from those estate agency companies appointed by the vendor) to act in the purchase of any specified residential property in the development, and may also not appoint any estate agent to Act on your behalf.
- Before you appoint an estate agent to look for a property, you should -
 - find out whether the agent will act on your behalf only. If the agent also acts for the vendor, he/she may not be able to protect your best interests in the event of a conflict of interest;

13. Pre-sale Consent

- For uncompleted residential property under the Lands Department Consent Scheme, seek confirmation from the vendor whether the "Pre-sale Consent" has been issued by the Lands Department for the development.

14. Show flats

- While the vendor is not required to make any show flat available for viewing by prospective purchasers or the general public, if the vendor wishes to make available show flats of a specified residential property, the vendor must first of all make available an unmodified show flat of that residential property and that, having made available such unmodified show flat, the vendor may then make available a modified show flat of that residential property. In this connection, the vendor is allowed to make available more than one modified show flat of that residential property.
- If you visit the show flats, you should always look at the unmodified show flats for comparison with the modified show flats. That said, the Ordinance does not restrict the discretion of the vendor in arranging the sequence of the viewing of unmodified and modified show flats.
- Sales brochure of the development should have been made available to the public when the show flat is made available for viewing. You are advised to get a copy of the sales brochure and make reference to it when viewing the show flats.
- You may take measurements in modified and unmodified show flats, and take photographs or make video recordings of unmodified show flats, subject to reasonable restriction(s) which may be set by the vendor for ensuring safety of the persons viewing the show flat.

For first-hand uncompleted residential properties and completed residential properties pending compliance

15. Estimated material date and handing over date

- Check the estimated material date³ for the development in the sales brochure -
 - The estimated material date for a development in the sales brochure is not the same as the date on which a residential property is handed over to purchaser. The latter is normally later than the former. However, the handing over date may be earlier than the estimated material date set out in the sales brochure in case of earlier completion of the development.
- Handing over date
 - The mandatory provisions to be incorporated in an ASP as required by the Ordinance include a provision requiring the vendor to apply in writing for an Occupation Document / a Certificate of Compliance or the Director of Lands' Consent to Assign (as the case may be) in respect of the development within 14 days after the estimated material date as stipulated in the ASP.
 - For development subject to the Lands Department Consent Scheme, the vendor is required to notify the purchaser in writing that the vendor is in a position validly to assign the property within one month after the issue of the Certificate of Compliance or the Consent to Assign, whichever first happens; or
 - For development not subject to the Lands Department Consent Scheme, the vendor is required to notify the purchaser in writing that the vendor is in a position validly to assign the property within 6 months after the issue of the Occupation Document including Occupation Permit.
 - The mandatory provisions to be incorporated in an ASP as required by the Ordinance include a provision requiring completion of the sale and purchase within 14 days after the date of the notification aforesaid. Upon completion, the vendor shall arrange handover of the property to the purchaser.
- Authorized Person (AP) may grant extension(s) of time for completion of the development beyond the estimated material date.

- The mandatory provisions to be incorporated in an ASP as required by the Ordinance include a provision that the AP of a development may grant an extension of time for completion of the development beyond the estimated material date having regard to delays caused exclusively by any one or more of the following reasons:

- strike or lock-out of workmen;
- riots or civil commotion;
- force majeure or act of God;
- fire or other accident beyond the vendor's control;
- war; or
- inclement weather.

- The AP may grant more than once such an extension of time depending on the circumstances. That means handover of the property may be delayed.

- The mandatory provisions to be incorporated in an ASP as required by the Ordinance also include a provision requiring the vendor to, within 14 days after the issue of an extension of time granted by the AP, furnish the purchaser with a copy of the relevant certificate of extension.

- Ask the vendor if there are any questions on handing over date.

For first-hand completed residential properties

16. Vendor's information form

- Ensure that you obtain the "vendor's information form(s)" printed within the previous 3 months in relation to the residential property/properties you intend to purchase.

17. Viewing of property

- Ensure that, before you purchase a residential property, you are arranged to view the residential property that you would like to purchase or, if it is not reasonably practicable to view the property in question, a comparable property in the development, unless you agree in writing that the vendor is not required to arrange such a comparable property for viewing for you. You are advised to think carefully before signing any waiver.
- You may take measurements, take photographs or make video recordings of the property, unless the property is held under a tenancy or reasonable restriction(s) is/are needed to ensure safety of the persons viewing the property.

³ Generally speaking, "material date" means the date on which the conditions of the land grant are complied with in respect of the development, or the date on which the development is completed in all respects in compliance with the approved building plans or the conditions subject to which the certificate of exemption is issued. For details, please refer to section 2 of the Ordinance.

For complaints and enquiries relating to the sales of first-hand residential properties by the vendors which the Ordinance applies, please contact the Sales of First-hand Residential Properties Authority -

Website	: www.srpa.gov.hk
Telephone	: 2817 3313
Email	: enquiry_srpa@hd.gov.hk
Fax	: 2219 2220

Other useful contacts:

Consumer Council

Website	: www.consumer.org.hk
Telephone	: 2929 2222
Email	: cc@consumer.org.hk
Fax	: 2856 3611

Estate Agents Authority

Website	: www.eaa.org.hk
Telephone	: 2111 2777
Email	: enquiry@eaa.org.hk
Fax	: 2598 9596

Real Estate Developers Association of Hong Kong

Telephone	: 2826 0111
Fax	: 2845 2521

Sales of First-hand Residential Properties Authority
March 2023

您在購置一手住宅物業之前，應留意下列事項：

適用於所有一手住宅物業

1. 重要資訊

- 瀏覽一手住宅物業銷售資訊網（下稱「銷售資訊網」）（網址：www.srpe.gov.hk），參考「銷售資訊網」內有關一手住宅物業的市場資料。
- 閱覽賣方就該發展項目所指定的互聯網網站內的有關資訊，包括售樓說明書、價單、載有銷售安排的文件，及成交紀錄冊。
- 發展項目的售樓說明書，會在該項目的出售日期前最少七日向公眾發布，而有關價單和銷售安排，亦會在該項目的出售日期前最少三日公布。
- 在賣方就有關發展項目所指定的互聯網網站，以及「銷售資訊網」內，均載有有關物業成交資料的成交紀錄冊，以供查閱。

2. 費用、按揭貸款和樓價

- 計算置業總開支，包括律師費、按揭費用、保險費，以及印花稅。
- 向銀行查詢可否取得所需的按揭貸款，然後選擇合適的還款方式，並小心計算按揭貸款金額，以確保貸款額沒有超出本身的負擔能力。
- 查閱同類物業最近的成交價格，以作比較。
- 向賣方或地產代理瞭解，您須付予賣方或該發展項目的管理人的預計的管理費、管理費上期金額（如有）、特別基金金額（如有）、補還的水、電力及氣體按金（如有），以及/或清理廢料的費用（如有）。

3. 價單、支付條款，以及其他財務優惠

- 賣方未必會把價單所涵蓋的住宅物業悉數推售，因此應留意有關的銷售安排，以了解賣方會推售的住宅物業為何。賣方會在有關住宅物業推售日期前最少三日公布銷售安排。
- 留意價單所載列的支付條款。倘買家可就購置有關住宅物業而連帶獲得價格折扣、贈品，或任何財務優惠或利益，上述資訊亦會在價單內列明。
- 如您擬選由賣方指定的財務機構提供的各類按揭貸款計劃，在簽訂臨時買賣合約前，應先細閱有關價單內列出的按揭貸款計劃資料¹。如就該些按揭貸款計劃的詳情有任何疑問，應在簽訂臨時買賣合約前，直接向有關財務機構查詢。

4. 物業的面積及四周環境

- 留意載於售樓說明書和價單內的物業面積資料，以及載於價單內的每平方呎/每平方米售價。根據《一手住宅物業銷售條例》（第621章）（下稱「條例」），賣方只可以實用面積表達住宅物業的面積和每平方呎及平方米的售價。就住宅物業而言，實用面積指該住宅物業的樓面面積，包括在構成該物業的一部分的範圍內的以下每一項目的樓面面積：(i) 露台；(ii) 工作平台；以及(iii) 陽台。實用面積並不包括空調機房、窗台、閣樓、平台、花園、停車位、天台、梯屋、前庭及庭院的每一項目的面積，即使該些項目構成該物業的一部分的範圍。
- 售樓說明書必須顯示發展項目中所有住宅物業的樓面平面圖。在售樓說明書所載有關發展項目中住宅物業的每一份樓面平面圖，均須述明每個住宅物業的外部及內部尺寸²。售樓說明書所提供有關住宅物業外部及內部的尺寸，不會把批盪和裝飾物料包括在內。買家收樓前如欲購置家具，應留意這點。
- 親臨發展項目的所在地實地視察，以了解有關物業的四周環境（包括交通和社區設施）；亦應查詢有否任何城市規劃方案和議決，會對有關的物業造成影響；參考載於售樓說明書內的位置圖、鳥瞰照片、分區計劃大綱圖，以及橫截面圖。

5. 售樓說明書

- 確保所取得的售樓說明書屬最新版本。根據條例，提供予公眾的售樓說明書必須是在之前的三個月之內印製或檢視、或檢視及修改。
- 如屬未落成發展項目，賣方在認為有需要時可改動建築圖則（如有的話），因此應留意由賣方提供的任何經修改的售樓說明書，以了解有關未落成發展項目的最新資料。
- 閱覽售樓說明書，並須特別留意以下資訊：
 - 售樓說明書內有否關於「有關資料」的部分，列出賣方知悉但並非為一般公眾人士所知悉，關於相當可能對享用有關住宅物業造成重大影響的事宜的資料。請注意，已在土地註冊處註冊的文件，其內容不會被視為「有關資料」；
 - 橫截面圖會顯示有關建築物相對毗連該建築物的每條街道的橫截面，以及每條上述街道與已知基準面和該建築物最低的一層住宅樓層的水平相對的水

¹ 按揭貸款計劃的資料包括有關按揭貸款計劃對借款人的最低收入的要求、就第一按揭連同第二按揭可獲得的按揭貸款金額上限、最長還款年期、整個還款期內的按揭利率變化，以及申請人須繳付的手續費。

² 根據條例附表1第1部第10(2)(d)條述明，售樓說明書內顯示的發展項目中的住宅物業的每一份樓面平面圖須述明以下各項—

- 每個住宅物業的外部尺寸；
- 每個住宅物業的內部尺寸；
- 每個住宅物業的內部間隔的厚度；
- 每個住宅物業內個別分隔室的外部尺寸。

根據條例附表1第1部第10(3)條，如有關發展項目的經批准的建築圖則，提供條例附表1第1部第10(2)(d)條所規定的資料，樓面平面圖須述明如此規定的該資料。

平。橫截面圖能以圖解形式，顯示出建築物最低一層住宅樓層和街道水平的高低差距，不論該最低住宅樓層以何種方式命名；

- 室內和外部的裝置、裝修物料和設備；
- 管理費按甚麼基準分擔；
- 小業主有否責任或需要分擔管理、營運或維持有關發展項目以內或以外的公眾休憩用地或公共設施的開支，以及有關公眾休憩用地或公共設施的位置；以及
- 小業主是否須要負責維修斜坡。

6. 政府批地文件和公契

- 閱覽政府批地文件和公契（或公契擬稿）。公契內載有天台和外牆業權等相關資料。賣方會在售樓處提供政府批地文件和公契（或公契擬稿）的複本，供準買家免費閱覽。
- 留意政府批地文件內所訂明小業主是否須要負責支付地稅。
- 留意公契內訂明有關物業內可否飼養動物。

7. 售樓處內有關可供揀選住宅物業的資料

- 向賣方查詢清楚有哪些一手住宅物業可供揀選。若賣方在售樓處內展示「消耗表」，您可從該「消耗表」得悉在每個銷售日的銷售進度資料，包括在該個銷售日開始時有哪些住宅物業可供出售，以及在該個銷售日內有哪些住宅物業已獲揀選及售出。
- 切勿隨便相信有關發展項目銷情的傳言，倉卒簽立臨時買賣合約。

8. 成交紀錄冊

- 留意發展項目的成交紀錄冊。賣方須於臨時買賣合約訂立後的 24 小時內，於紀錄冊披露該臨時買賣合約的資料，以及於買賣合約訂立後一個工作天內，披露該買賣合約的資料。您可透過成交紀錄冊得悉發展項目的銷售情況。
- 切勿將賣方接獲用作登記的購樓意向書或本票的數目視為銷情指標。發展項目的成交紀錄冊才是讓公眾掌握發展項目每日銷售情況的最可靠資料來源。

9. 買賣合約

- 確保臨時買賣合約和買賣合約包含條例所規定的強制性條文。
- 留意有關物業買賣交易所包括的裝置、裝修物料和設備，須在臨時買賣合約和買賣合約上列明。

- 留意夾附於買賣合約的圖則。該圖則會顯示所有賣方售予您的物業面積，而該面積通常較該物業的實用面積為大。
- 留意賣方有權改動未落成發展項目的建築圖則（如有的話）。如屬未落成發展項目，條例規定物業的買賣合約須載有強制性條文，列明如有關改動在任何方面對該物業造成影響，賣方須在改動獲建築事務監督批准後的 14 日內，將該項改動以書面通知買家。
- 訂立臨時買賣合約時，您須向擁有人（即賣方）支付樓價 **5%** 的臨時訂金。
- 如您在訂立臨時買賣合約後 **五個工作日**（工作日指並非公眾假日、星期六、黑色暴雨警告日或烈風警告日的日子）之內，沒有簽立買賣合約，該臨時買賣合約即告終止，有關臨時訂金（即樓價的 5%）會被沒收，而擁有人（即賣方）不得因您沒有簽立買賣合約而對您提出進一步申索。
- 在訂立臨時買賣合約後的五個工作日之內，倘您簽立買賣合約，則擁有人（即賣方）必須在訂立該臨時買賣合約後的八個工作日之內簽立買賣合約。
- 有關的訂金，應付予負責為所涉物業擔任保證金保存人的律師事務所。

10. 表達購樓意向

- 留意在賣方（包括其獲授權代表）就有關住宅物業向公眾提供價單前，賣方不得尋求或接納任何對有關住宅物業的購樓意向（不論是否屬明確選擇購樓意向）。因此您不應向賣方或其授權代表提出有關意向。
- 留意在有關住宅物業的銷售開始前，賣方（包括其獲授權代表）不得尋求或接納任何對該物業的有明確選擇購樓意向。因此您不應向賣方或其授權代表提出有關意向。

11. 委託地產代理

- 留意倘賣方委任一個或多於一個地產代理，以協助銷售其發展項目內任何指明住宅物業，該發展項目的價單必須列明在價單印刷日期當日所有獲委任為地產代理的姓名/名稱。
- 您可委託任何地產代理（不一定是賣方所指定的地產代理），以協助您購置發展項目內任何指明住宅物業；您亦可不委託任何地產代理。
- 委託地產代理以物色物業前，您應該 —
 - 了解該地產代理是否只代表您行事。該地產代理若同時代表賣方行事，倘發生利益衝突，未必能夠保障您的最大利益；
 - 了解您須否支付佣金予該地產代理。若須支付，有關的佣金金額和支付日期為何；以及

- 留意只有持牌地產代理或營業員才可以接受您的委託。如有疑問，應要求該地產代理或營業員出示其「地產代理證」，或瀏覽地產代理監局的網頁（網址：www.eaa.org.hk），查閱牌照目錄。

12. 委聘律師

- 考慮自行委聘律師，以保障您的利益。該律師若同時代表賣方行事，倘發生利益衝突，未必能夠保障您的最大利益。
- 比較不同律師的收費。

適用於一手未落成住宅物業

13. 預售樓花同意書

- 洽購地政總署「預售樓花同意方案」下的未落成住宅物業時，應向賣方確認地政總署是否已就該發展項目批出「預售樓花同意書」。

14. 示範單位

- 賣方不一定須設置示範單位供準買家或公眾參觀，但賣方如為某指明住宅物業設置示範單位，必須首先設置該住宅物業的無改動示範單位，才可設置該住宅物業的經改動示範單位，並可以就該住宅物業設置多於一個經改動示範單位。
- 參觀示範單位時，務必視察無改動示範單位，以便與經改動示範單位作出比較。然而，條例並沒有限制賣方安排參觀無改動示範單位及經改動示範單位的先後次序。
- 賣方設置示範單位供公眾參觀時，應已提供有關發展項目的售樓說明書。因此，緊記先行索取售樓說明書，以便在參觀示範單位時參考相關資料。
- 您可以在無改動示範單位及經改動示範單位中進行量度，並在無改動示範單位內拍照或拍攝影片，惟在確保示範單位參觀者人身安全的前提下，賣方可能會設定合理的限制。

適用於一手未落成住宅物業及尚待符合條件的已落成住宅物業

15. 預計關鍵日期及收樓日期

- 查閱售樓說明書中有關發展項目的預計關鍵日期³。
- 售樓說明書中有關發展項目的預計關鍵日期並不同買家的「收樓日期」。買家的「收樓日期」一般會較發展項目的預計關鍵日期遲。然而，假若發展項目比預期早落成，「收樓日期」可能會較售樓說明書列出的預計關鍵日期為早。

³ 一般而言，「關鍵日期」指該項目符合批地文件的條件的日期，或該項目在遵照經批准的建築圖則的情況下或按照豁免證明書的發出的條件在各方面均屬完成的日期。有關詳情請參考條例第2條。

收樓日期

- 條例規定買賣合約須載有強制性條文，列明賣方須於買賣合約內列出的預計關鍵日期後的14日內，以書面為發展項目申請佔用文件、合格證明書，或地政總署署長的轉讓同意（視屬何種情況而定）。

- 如發展項目屬地政總署預售樓花同意方案所規管，賣方須在合格證明書或地政總署署長的轉讓同意發出後的一個月內（以較早者為準），就賣方有能力有效地轉讓有關物業一事，以書面通知買家；或

- 如發展項目並非屬地政總署預售樓花同意方案所規管，賣方須在佔用文件（包括佔用許可證）發出後的六個月內，就賣方有能力有效地轉讓有關物業一事，以書面通知買家。

- 條例規定買賣合約須載有強制性條文，列明有關物業的買賣須於賣方發出上述通知的日期的14日內完成。有關物業的買賣完成後，賣方將安排買家收樓事宜。

認可人士可批予在預計關鍵日期之後完成發展項目

- 條例規定買賣合約須載有強制性條文，列明發展項目的認可人士可以在顧及純粹由以下一個或多於一個原因所導致的延遲後，批予在預計關鍵日期之後，完成發展項目：

- 工人罷工或封閉工地；
- 暴動或內亂；
- 不可抗力或天災；
- 火警或其他賣方所不能控制的意外；
- 戰爭；或
- 惡劣天氣。

- 發展項目的認可人士可以按情況，多於一次批予延後預計關鍵日期以完成發展項目，即收樓日期可能延遲。

- 條例規定買賣合約須載有強制性條文，列明賣方須於認可人士批予延期後的14日內，向買家提供有關延期證明書的文本。

- 如對收樓日期有任何疑問，可向賣方查詢。

適用於一手已落成住宅物業

16. 賣方資料表格

- 確保取得最近三個月內印製有關您擬購買的一手已落成住宅物業的「賣方資料表格」。

17. 參觀物業

- 購置住宅物業前，確保已獲安排參觀您打算購置的住宅物業。倘參觀有關物業並非合理地切實可行，則應參觀與有關物業相若的物業，除非您以書面同意賣方無須開放與有關物業相若的物業供您參觀。您應仔細考慮，然後才決定是否簽署豁免上述規定的書面同意。
- 除非有關物業根據租約持有，或為確保物業參觀者的人身安全而須設定合理限制，您可以對該物業進行量度、拍照或拍攝影片。

任何與賣方銷售受條例所規管的一手住宅物業有關的投訴和查詢，請與一手住宅物業銷售監管局聯絡。

網址	: www.srpa.gov.hk
電話	: 2817 3313
電郵	: enquiry_srpa@hd.gov.hk
傳真	: 2219 2220

其他相關聯絡資料：

消費者委員會	
網址	: www.consumer.org.hk
電話	: 2929 2222
電郵	: cc@consumer.org.hk
傳真	: 2856 3611

地產代理監管局	
網址	: www.eaa.org.hk
電話	: 2111 2777
電郵	: enquiry@eaa.org.hk
傳真	: 2598 9596

香港地產建設商會	
電話	: 2826 0111
傳真	: 2845 2521

一手住宅物業銷售監管局

2023年3月

Name of the Development

77/79 PEAK ROAD

發展項目名稱

77/79 PEAK ROAD

Name of the street and the street number

79 Peak Road

79A Peak Road

77 Peak Road

街道名稱及門牌號數

山頂道79號

山頂道79A號

山頂道77號

The total number of houses

8 Houses

獨立屋的總數

8座獨立屋

The house numbering as provided in the approved building plans for the Development

79 Peak Road

79A Peak Road

77A Peak Road

77B Peak Road

77C Peak Road

77D Peak Road

77E Peak Road

77F Peak Road

發展項目的經批准的建築圖則所規定的門牌號數

山頂道79號

山頂道79A號

山頂道77A號

山頂道77B號

山頂道77C號

山頂道77D號

山頂道77E號

山頂道77F號

Omitted house number

Not Applicable

被略去的門牌號數

不適用

Vendor

Wharf Peak Properties Limited
Affluent Peak Limited*
Deluxe Achieve Limited*

Holding Companies of the Vendor

Wharf Peak Properties Limited:
Prestige Grove Limited
Silver Flags Limited
Wharf Development Limited
The Wharf (Holdings) Limited
Innovative Circle Limited
World International Asset Management Limited
World International Holdings Limited
Wheelock and Company Limited

Affluent Peak Limited#:
Rosy Petal Limited

Deluxe Achieve Limited#:
Bright Cherry Limited

Authorized Person for the Development

Mr. Ng Chi Ho

The firm or corporation of which the Authorized Person for the Development is a proprietor, director or employee in his or her professional capacity

Handi Architects Limited

Building Contractor for the Development

Hip Hing Construction Company Limited

The firm of solicitors acting for the owner in relation to the sale of residential properties in the Development

Woo Kwan Lee and Lo

Authorized institution that has made a loan, or has undertaken to provide finance, for the construction of the Development

Not Applicable

Other person who has made a loan for the construction of the Development

Wharf Finance Limited
Wharf Finance (BVI) Limited

Remarks:

* Wharf Peak Properties Limited has sold the following residential properties to the following companies, which are/were associated corporations of Wharf Peak Properties Limited as at the dates of the relevant agreement(s) for sale and purchase and/or assignment(s):-

Name of company	Residential property
Affluent Peak Limited	79 Peak Road
Deluxe Achieve Limited	79A Peak Road

The shares of the holding companies of Affluent Peak Limited and Deluxe Achieve Limited have been transferred and the said companies have no longer been associated corporations of Wharf Peak Properties Limited. Information on the holding companies of the said companies set out in this sales brochure is based on the information as at the relevant dates of the transfers.

賣方

Wharf Peak Properties Limited
Affluent Peak Limited*
Deluxe Achieve Limited*

賣方的控權公司

Wharf Peak Properties Limited:
Prestige Grove Limited
Silver Flags Limited
Wharf Development Limited
九龍倉集團有限公司
Innovative Circle Limited
World International Asset Management Limited
World International Holdings Limited
會德豐有限公司

Affluent Peak Limited#:
Rosy Petal Limited

Deluxe Achieve Limited#:
Bright Cherry Limited

發展項目的認可人士

吳智豪先生

發展項目的認可人士以其專業身分擔任經營人、董事或僱員的商號或法團

恒達建築師有限公司

發展項目的承建商

協興建築有限公司

就發展項目中的住宅物業的出售而代表擁有人行事的律師事務所

胡關李羅律師行

已為發展項目的建造提供貸款或已承諾為該項建造提供融資的認可機構

不適用

已為發展項目的建造提供貸款的其他人

Wharf Finance Limited
Wharf Finance (BVI) Limited

備註：

* Wharf Peak Properties Limited 已將以下住宅物業出售予以下公司，該等公司於相關買賣合約及/或轉讓契日期均為 Wharf Peak Properties Limited 的有聯繫法團：

公司名稱	住宅物業
Affluent Peak Limited	山頂道79號
Deluxe Achieve Limited	山頂道79A號

Affluent Peak Limited 及 Deluxe Achieve Limited 的控權公司的股份已轉讓，該等公司不再是 Wharf Peak Properties Limited 的有聯繫法團。本售樓說明書所載有關該等公司的控權公司的資料乃基於截至有關轉讓日期的資料。

<p>(a) The vendor or a building contractor for the development is an individual, and that vendor or contractor is an immediate family member of an authorized person for the development; 賣方或有關發展項目的承建商屬個人，並屬該項目的認可人士的家人；</p>	<p>Not Applicable 不適用</p>
<p>(b) The vendor or a building contractor for the development is a partnership, and a partner of that vendor or contractor is an immediate family member of such an authorized person; 賣方或該項目的承建商屬合夥，而該賣方或承建商的合夥人屬上述認可人士的家人；</p>	<p>Not Applicable 不適用</p>
<p>(c) The vendor or a building contractor for the development is a corporation, and a director or the secretary of that vendor or contractor (or a holding company of that vendor) is an immediate family member of such an authorized person; 賣方或該項目的承建商屬法團，而該賣方或承建商(或該賣方的控權公司)的董事或秘書屬上述認可人士的家人；</p>	<p>No 否</p>
<p>(d) The vendor or a building contractor for the development is an individual, and that vendor or contractor is an immediate family member of an associate of such an authorized person; 賣方或該項目的承建商屬個人，並屬上述認可人士的有聯繫人士的家人；</p>	<p>Not Applicable 不適用</p>
<p>(e) The vendor or a building contractor for the development is a partnership, and a partner of that vendor or contractor is an immediate family member of an associate of such an authorized person; 賣方或該項目的承建商屬合夥，而該賣方或承建商的合夥人屬上述認可人士的有聯繫人士的家人；</p>	<p>Not Applicable 不適用</p>
<p>(f) The vendor or a building contractor for the development is a corporation, and a director or the secretary of that vendor or contractor (or a holding company of that vendor) is an immediate family member of an associate of such an authorized person; 賣方或該項目的承建商屬法團，而該賣方或承建商(或該賣方的控權公司)的董事或秘書屬上述認可人士的有聯繫人士的家人；</p>	<p>No 否</p>
<p>(g) The vendor or a building contractor for the development is an individual, and that vendor or contractor is an immediate family member of a proprietor of a firm of solicitors acting for the owner in relation to the sale of residential properties in the development; 賣方或該項目的承建商屬個人，並屬就該項目內的住宅物業的出售代表擁有人行事的律師事務所行事的經營人的家人；</p>	<p>Not Applicable 不適用</p>
<p>(h) The vendor or a building contractor for the development is a partnership, and a partner of that vendor or contractor is an immediate family member of a proprietor of a firm of solicitors acting for the owner in relation to the sale of residential properties in the development; 賣方或該項目的承建商屬合夥，而該賣方或承建商的合夥人屬就該項目內的住宅物業的出售代表擁有人行事的律師事務所行事的經營人的家人；</p>	<p>Not Applicable 不適用</p>
<p>(i) The vendor or a building contractor for the development is a corporation, and a director or the secretary of that vendor or contractor (or a holding company of that vendor) is an immediate family member of a proprietor of such a firm of solicitors; 賣方或該項目的承建商屬法團，而該賣方或承建商(或該賣方的控權公司)的董事或秘書屬上述律師事務所的經營人的家人；</p>	<p>No 否</p>
<p>(j) The vendor, a holding company of the vendor, or a building contractor for the development, is a private company, and an authorized person for the development, or an associate of such an authorized person, holds at least 10% of the issued shares in that vendor, holding company or contractor; 賣方、賣方的控權公司或有關發展項目的承建商屬私人公司，而該項目的認可人士或該認可人士的有聯繫人士持有該賣方、控權公司或承建商最少10%的已發行股份；</p>	<p>No 否</p>

RELATIONSHIP BETWEEN PARTIES INVOLVED IN THE DEVELOPMENT
有參與發展項目的各方的關係

<p>(k) The vendor, a holding company of the vendor, or a building contractor for the development, is a listed company, and such an authorized person, or such an associate, holds at least 1% of the issued shares in that vendor, holding company or contractor; 賣方、賣方的控權公司或該項目的承建商屬上市公司，而上述認可人士或上述有聯繫人士持有該賣方、控權公司或承建商最少1%的已發行股份；</p>	No 否
<p>(l) The vendor or a building contractor for the development is a corporation, and such an authorized person, or such an associate, is an employee, director or secretary of that vendor or contractor or of a holding company of that vendor; 賣方或該項目的承建商屬法團，而上述認可人士或上述有聯繫人士屬該賣方、承建商或該賣方的控權公司的僱員、董事或秘書；</p>	No 否
<p>(m) The vendor or a building contractor for the development is a partnership, and such an authorized person, or such an associate, is an employee of that vendor or contractor; 賣方或該項目的承建商屬合夥，而上述認可人士或上述有聯繫人士屬該賣方或承建商的僱員；</p>	Not Applicable 不適用
<p>(n) The vendor, a holding company of the vendor, or a building contractor for the development, is a private company, and a proprietor of a firm of solicitors acting for the owner in relation to the sale of residential properties in the development holds at least 10% of the issued shares in that vendor, holding company or contractor; 賣方、賣方的控權公司或該項目的承建商屬私人公司，而就該項目中的住宅物業的出售而代表擁有人行事的律師事務所的經營人持有該賣方、控權公司或承建商最少10%的已發行股份；</p>	No 否
<p>(o) The vendor, a holding company of the vendor, or a building contractor for the development, is a listed company, and a proprietor of such a firm of solicitors holds at least 1% of the issued shares in that vendor, holding company or contractor; 賣方、賣方的控權公司或該項目的承建商屬上市公司，而上述律師事務所的經營人持有該賣方、控權公司或承建商最少1%的已發行股份；</p>	No 否
<p>(p) The vendor or a building contractor for the development is a corporation, and a proprietor of such a firm of solicitors is an employee, director or secretary of that vendor or contractor or of a holding company of that vendor; 賣方或該項目的承建商屬法團，而上述律師事務所的經營人屬該賣方或承建商或該賣方的控權公司的僱員、董事或秘書；</p>	No 否
<p>(q) The vendor or a building contractor for the development is a partnership, and a proprietor of such a firm of solicitors is an employee of that vendor or contractor; 賣方或該項目的承建商屬合夥，而上述律師事務所的經營人屬該賣方或承建商的僱員；</p>	Not Applicable 不適用
<p>(r) The vendor or a building contractor for the development is a corporation, and the corporation of which an authorized person for the development is a director or employee in his or her professional capacity is an associate corporation of that vendor or contractor or of a holding company of that vendor; 賣方或該項目的承建商屬法團，而該項目的認可人士以其專業身份擔任董事或僱員的法團為該賣方或承建商或該賣方的控權公司的有聯繫法團；</p>	No 否
<p>(s) The vendor or a building contractor for the development is a corporation, and that contractor is an associate corporation of that vendor or of a holding company of that vendor. 賣方或該項目的承建商屬法團，而該承建商屬該賣方或該賣方的控權公司的有聯繫法團。</p>	No 否

There are non-structural prefabricated external walls forming part of the enclosing walls of the Development.

發展項目有構成圍封牆的一部分的非結構的預製外牆。

The thickness of the non-structural prefabricated external walls of each block is 150mm.

每幢建築物的非結構的預製外牆的厚度為150毫米。

There are curtain walls forming part of the enclosing walls of the Development.

發展項目有構成圍封牆的一部分的幕牆。

The thickness of the curtain walls of each building is 250mm (except 79 and 77F Peak Road).

每幢建築物的幕牆的厚度為250毫米（山頂道79及77F號除外）。

Schedule of Total Areas of the Non-structural Prefabricated External Walls and Curtain Walls of Each Residential Property:

每個住宅物業的非結構的預製外牆及幕牆的總面積表：

House Number 屋號	Total area of the non-structural prefabricated external walls of each residential property (sq.m.) 每個住宅物業的非結構的預製外牆的總面積 (平方米)	Total area of the curtain walls of each residential property (sq.m.) 每個住宅物業的幕牆的總面積 (平方米)
79 Peak Road 山頂道79號	6.424	-
79A Peak Road 山頂道79A號	10.589	4.746
77A Peak Road 山頂道77A號	5.882	4.431
77B Peak Road 山頂道77B號	9.225	2.525
77C Peak Road 山頂道77C號	9.000	5.050
77D Peak Road 山頂道77D號	8.411	2.525
77E Peak Road 山頂道77E號	6.713	4.000
77F Peak Road 山頂道77F號	3.90	-

Person appointed as the manager of the Development under the deed of mutual covenant that has been executed

Harriman Property Management Limited

根據已簽立的公契，獲委任為發展項目的管理人的人

夏利文物業管理有限公司

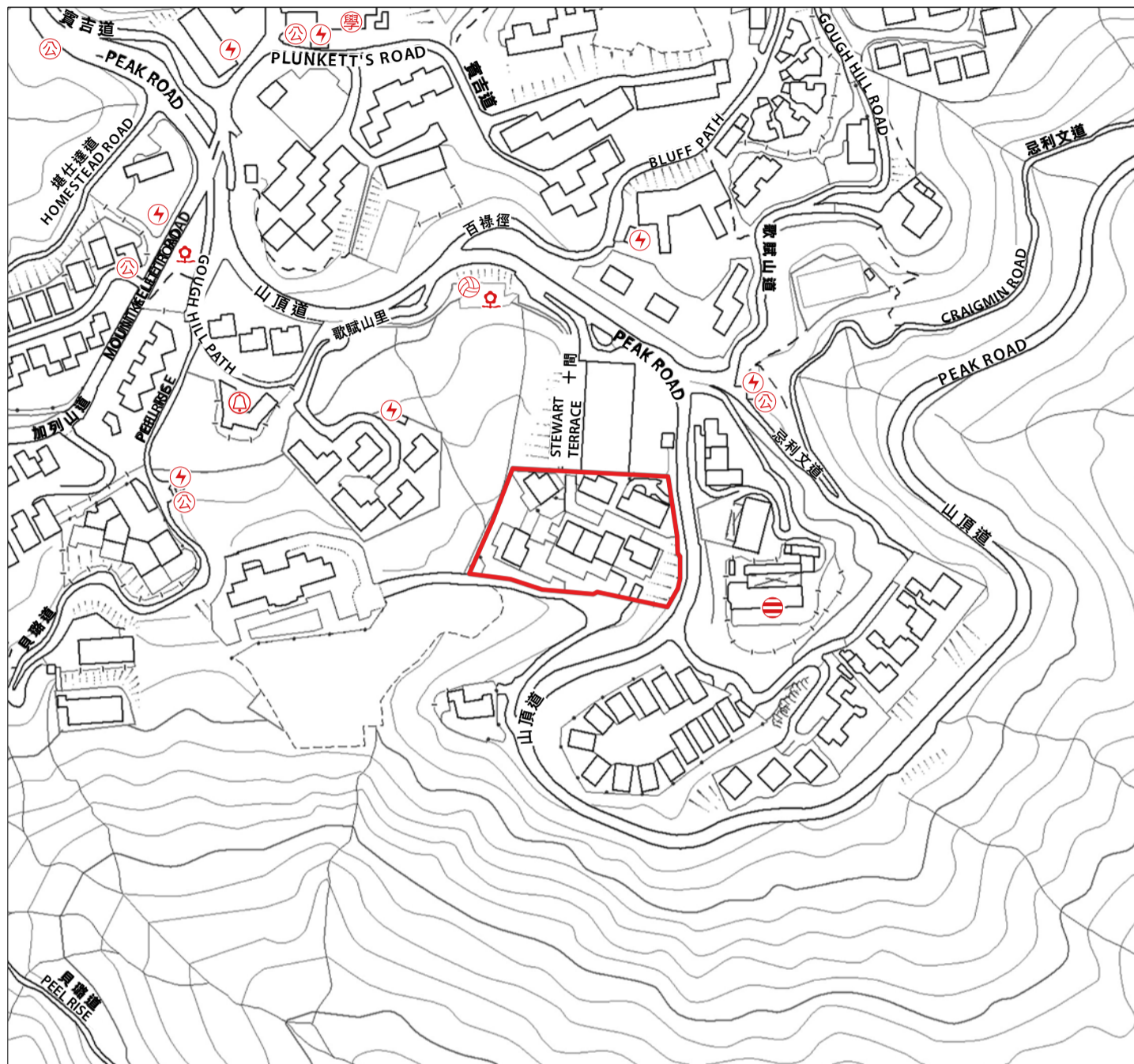

 **Boundary of the Development**
發展項目的界線

Scale: M 0 100 200 250
比例：米

The location plan is prepared by the Vendor with reference to Survey Sheet No.T11-SW-C dated 2nd January 2025 and T11-SW-D dated 19th December 2024 from Survey and Mapping Office of the Lands Department, with adjustment where necessary.

此所在位置圖是由賣方參考了地政總署測繪處於2025年1月2日(編號T11-SW-C)及於2024年12月19日(編號T11-SW-D)出版之測繪圖所擬備，並經修正處理。

NOTATION 圖例

 Power Plant (including electricity sub-stations)
發電廠 (包括電力分站)

 Fire Station 消防局

 Police Station 警署

 Public Utility Installation 公用事業設施裝置

 School (including kindergarten) 學校 (包括幼稚園)

 Sports Facilities (including Sports Ground and Swimming pool)
體育設施 (包括運動場及游泳池)

 Public Park 公園

Notes :

1. The Vendor advises prospective purchasers to conduct an on-site visit for a better understanding of the Development site, its surrounding environment and the public facilities nearby.
2. The location plan may show more than the area required under the Residential Properties (First-hand Sales) Ordinance due to the technical reason that the boundary of the Development is irregular.
3. The Map is provided by the CSDI Portal and intellectual property rights are owned by the Government of the HKSAR.

附註：

1. 賣方建議準買方到該發展地盤作實地考察，以對該發展地盤、其周邊地區環境及附近的公共設施有較佳了解。
2. 由於發展項目的邊界不規則的技術原因，所在位置圖可能顯示多於《一手住宅物業銷售條例》所要求顯示的範圍。
3. 地圖由空間數據共享平台提供，香港特別行政區政府為知識產權擁有人。

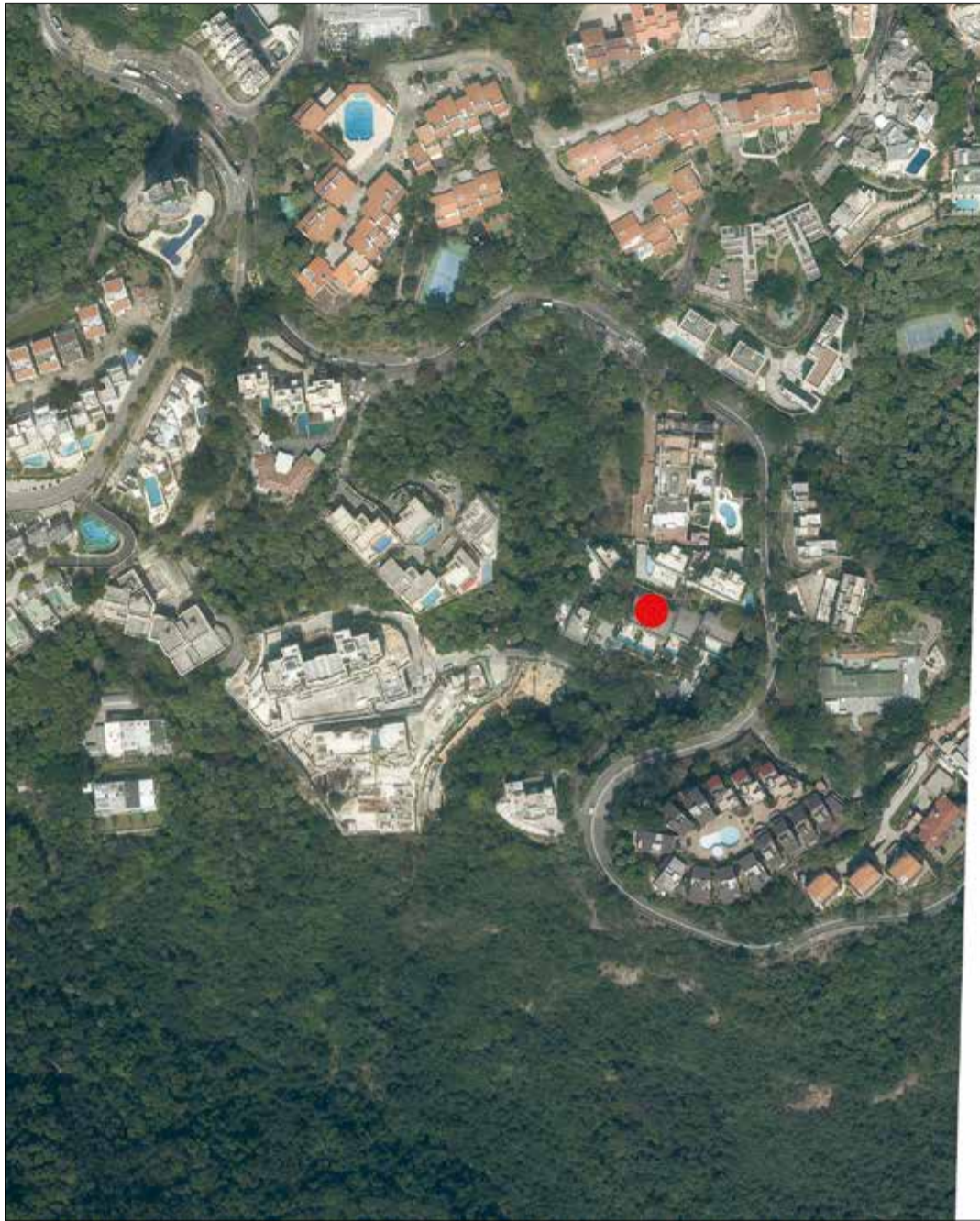

This blank area falls outside the coverage of the aerial photograph
鳥瞰照片並不覆蓋本空白範圍



Location of the Development
發展項目的位置

Extract from the aerial photograph taken by the Survey and Mapping Office of the Lands Department at a flying height of 6,900 feet, photo No.E199469C, dated 6th March 2023.

摘錄自地政總署測繪處於2023年3月6日在6,900呎飛行高度拍攝之鳥瞰照片，編號為E199469C。

Notes :

1. The Aerial Photograph is provided by the CSDI Portal and intellectual property rights are owned by the Government of the HKSAR.
2. Survey and Mapping Office, Lands Department, The Government of HKSAR © copyright reserved - reproduction by permission only.
3. The Vendor advises prospective purchasers to conduct an on-site visit for a better understanding of the Development site, its surrounding environment and the public facilities nearby.
4. The aerial photograph may show more than the area required under the Residential Properties (First-hand Sales) Ordinance due to the technical reason that the boundary of the Development is irregular.

附註：

1. 鳥瞰照片由空間數據共享平台提供，香港特別行政區政府為知識產權擁有人。
2. 香港特別行政區地政總署測繪處©版權所有，未經許可，不得複製。
3. 賣方建議買方到該發展地盤作實地考察，以獲取對該發展地盤以及周圍地區的公共設施及環境較佳的了解。
4. 由於發展項目的邊界不規則的技術原因，鳥瞰照片可能顯示多於《一手住宅物業銷售條例》所要求顯示的範圍。

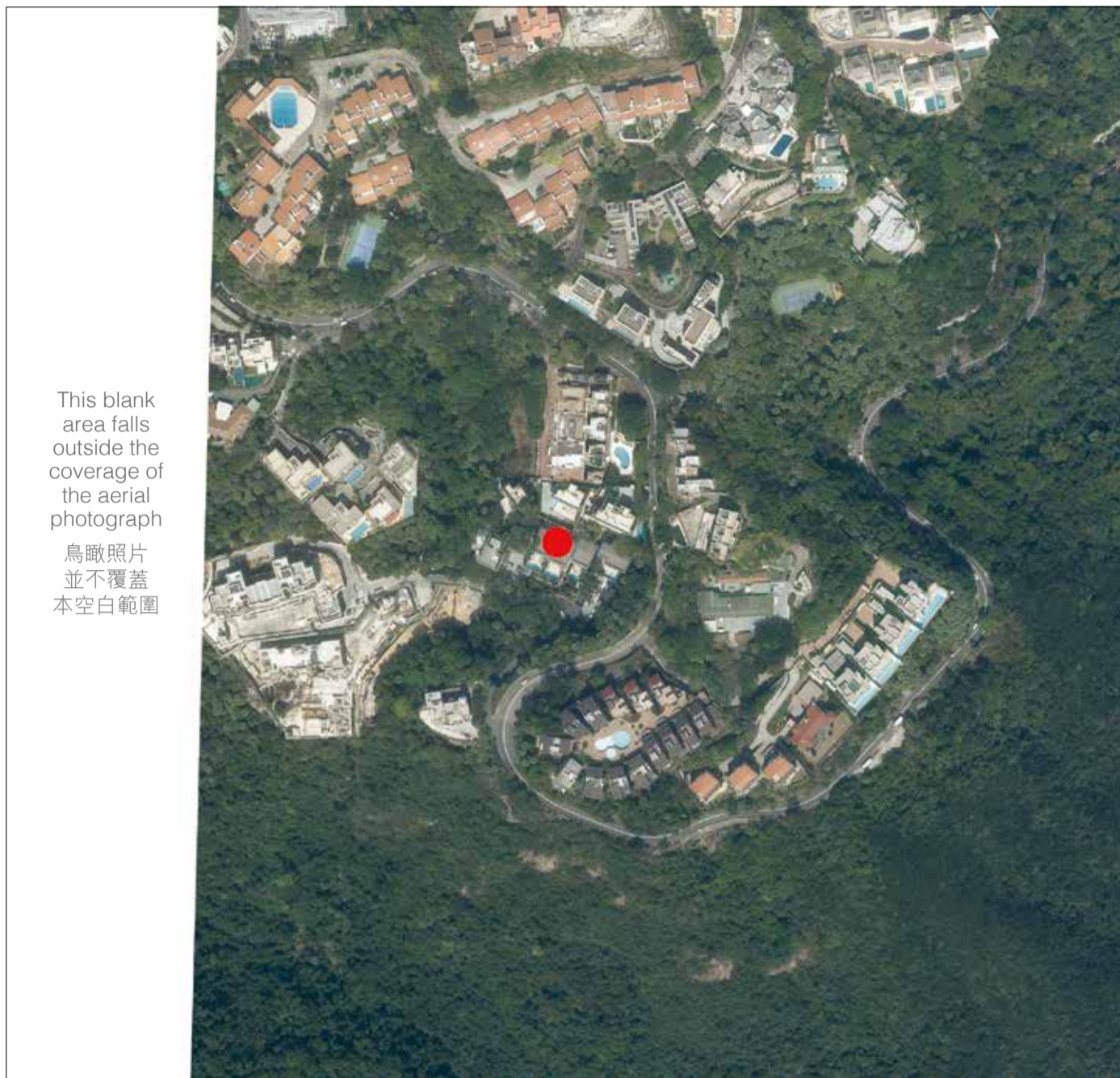

This blank area falls outside the coverage of the aerial photograph

鳥瞰照片並不覆蓋本空白範圍



Location of the Development
發展項目的位置

Extract from the aerial photograph taken by the Survey and Mapping Office of the Lands Department at a flying height of 6,900 feet, photo No.E199470C, dated 6th March 2023.

摘錄自地政總署測繪處於2023年3月6日在6,900呎飛行高度拍攝之鳥瞰照片，編號為E199470C。

Notes :

1. The Aerial Photograph is provided by the CSDI Portal and intellectual property rights are owned by the Government of the HKSAR.
2. Survey and Mapping Office, Lands Department, The Government of HKSAR © copyright reserved - reproduction by permission only.
3. The Vendor advises prospective purchasers to conduct an on-site visit for a better understanding of the Development site, its surrounding environment and the public facilities nearby.
4. The aerial photograph may show more than the area required under the Residential Properties (First-hand Sales) Ordinance due to the technical reason that the boundary of the Development is irregular.

附註：

1. 鳥瞰照片由空間數據共享平台提供，香港特別行政區政府為知識產權擁有人。
2. 香港特別行政區地政總署測繪處©版權所有，未經許可，不得複製。
3. 賣方建議買方到該發展地盤作實地考察，以獲取對該發展地盤以及周圍地區的公共設施及環境較佳的了解。
4. 由於發展項目的邊界不規則的技術原因，鳥瞰照片可能顯示多於《一手住宅物業銷售條例》所要求顯示的範圍。



Location of the Development

發展項目的位置

Extract from the aerial photograph taken by the Survey and Mapping Office of the Lands Department at a flying height of 6,000 feet, photo No.E212810C, dated 22nd November 2023.

摘錄自地政總署測繪處於2023年11月22日在6,000呎飛行高度拍攝之鳥瞰照片，編號為E212810C。

Notes :

1. The Aerial Photograph is provided by the CSDI Portal and intellectual property rights are owned by the Government of the HKSAR.
2. Survey and Mapping Office, Lands Department, The Government of HKSAR © copyright reserved - reproduction by permission only.
3. The Vendor advises prospective purchasers to conduct an on-site visit for a better understanding of the Development site, its surrounding environment and the public facilities nearby.
4. The aerial photograph may show more than the area required under the Residential Properties (First-hand Sales) Ordinance due to the technical reason that the boundary of the Development is irregular.

附註：

1. 鳥瞰照片由空間數據共享平台提供，香港特別行政區政府為知識產權擁有人。
2. 香港特別行政區地政總署測繪處©版權所有，未經許可，不得複製。
3. 賣方建議買方到該發展地盤作實地考察，以獲取對該發展地盤以及周圍地區的公共設施及環境較佳的了解。
4. 由於發展項目的邊界不規則的技術原因，鳥瞰照片可能顯示多於《一手住宅物業銷售條例》所要求顯示的範圍。

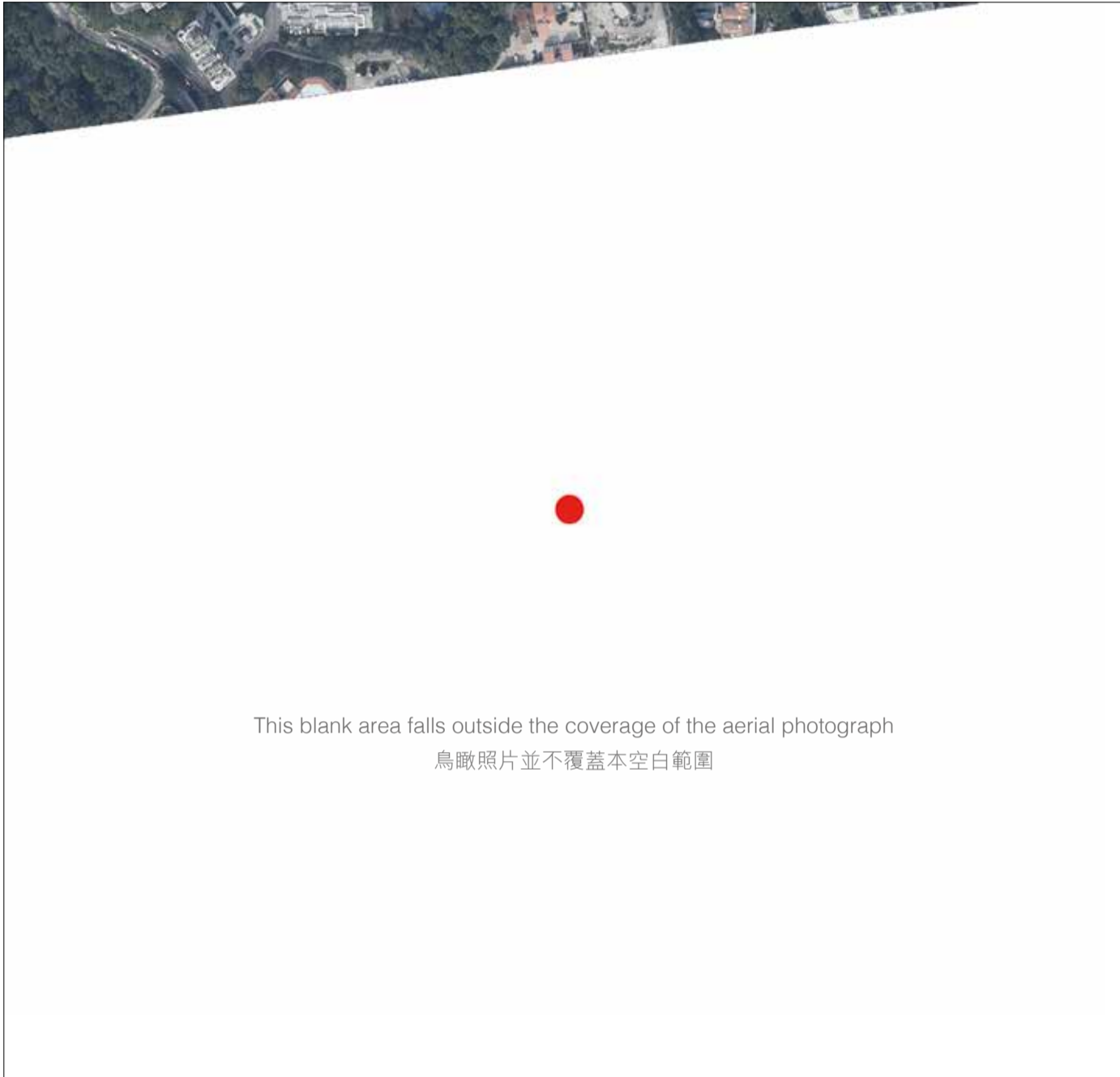

● Location of the Development
發展項目的位置

Extract from the aerial photograph taken by the Survey and Mapping Office of the Lands Department at a flying height of 6,000 feet, photo No.E219051C, dated 8th March 2024.

摘錄自地政總署測繪處於2024年3月8日在6,000呎飛行高度拍攝之鳥瞰照片，編號為E219051C。

Notes :

1. The Aerial Photograph is provided by the CSDI Portal and intellectual property rights are owned by the Government of the HKSAR.
2. Survey and Mapping Office, Lands Department, The Government of HKSAR © copyright reserved - reproduction by permission only.
3. The Vendor advises prospective purchasers to conduct an on-site visit for a better understanding of the Development site, its surrounding environment and the public facilities nearby.
4. The aerial photograph may show more than the area required under the Residential Properties (First-hand Sales) Ordinance due to the technical reason that the boundary of the Development is irregular.

附註：

1. 鳥瞰照片由空間數據共享平台提供，香港特別行政區政府為知識產權擁有人。
2. 香港特別行政區地政總署測繪處©版權所有，未經許可，不得複製。
3. 賣方建議買方到該發展地盤作實地考察，以獲取對該發展地盤以及周圍地區的公共設施及環境較佳的了解。
4. 由於發展項目的邊界不規則的技術原因，鳥瞰照片可能顯示多於《一手住宅物業銷售條例》所要求顯示的範圍。

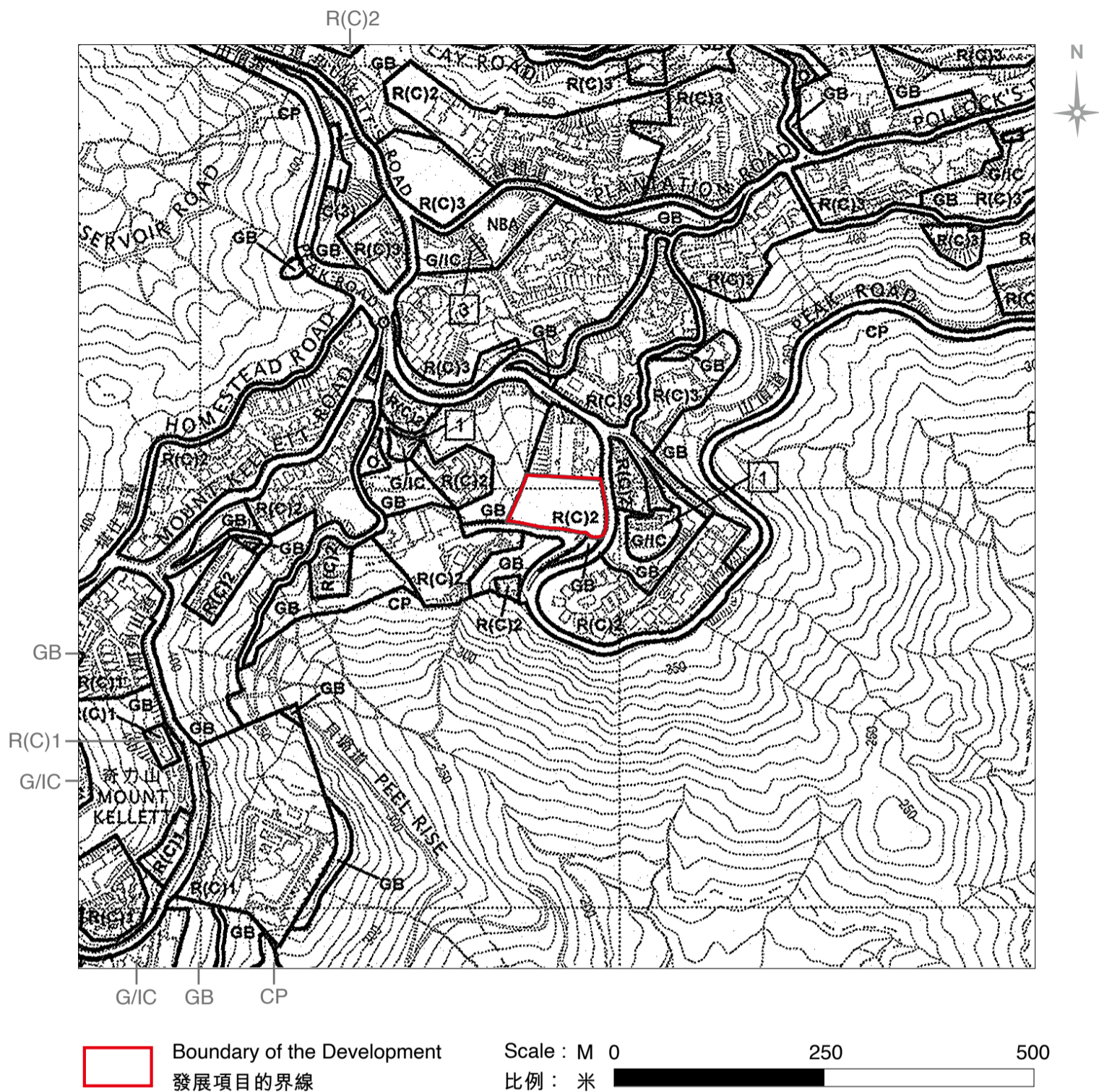

Extract from the approved The Peak Area Outline Zoning plan No. S/H14/13, gazetted on 6 April 2018.

摘錄自於2018年4月6日憲報公布之山頂區分區計劃大綱核准圖，編號為S/H14/13。

NOTATION 圖例

ZONES 地帶

Residential (Group C) 住宅 (丙類)	R(C)
Government, Institution or Community 政府、機構或社區	G/IC
Open Space 休憩用地	O
Green Belt 綠化地帶	GB
Country Park 郊野公園	CP

COMMUNICATIONS 交通

Major Road and Junction 主要道路及路口

MISCELLANEOUS 其他

Maximum Building Height (in number of storeys) 最高建築物高度 (樓層數目) 2

Non-Building Area 非建築用地 NBA

Notes :

- The map, prepared by the Planning Department under the direction of the Town Planning Board, is reproduced with permission of the Director of Lands © Government of Hong Kong SAR.
- The Vendor advises prospective purchasers to conduct an on-site visit for a better understanding of the Development site, its surrounding environment and the public facilities nearby.
- The outline zoning plan may show more than the area required under the Residential Properties (First-hand Sales) Ordinance due to the technical reason that the boundary of the Development is irregular.

附註：

- 地圖為規劃署遵照城市規劃委員會指示擬備，版權屬香港特別行政區政府，經地政總署准許複印。
- 賣方建議買方到該發展地盤作實地考察，以獲取對該發展地盤以及周圍地區的公共設施及環境較佳的了解。
- 由於發展項目的邊界不規則的技術原因，分區計劃大綱圖可能顯示多於《一手住宅物業銷售條例》所要求顯示的範圍。

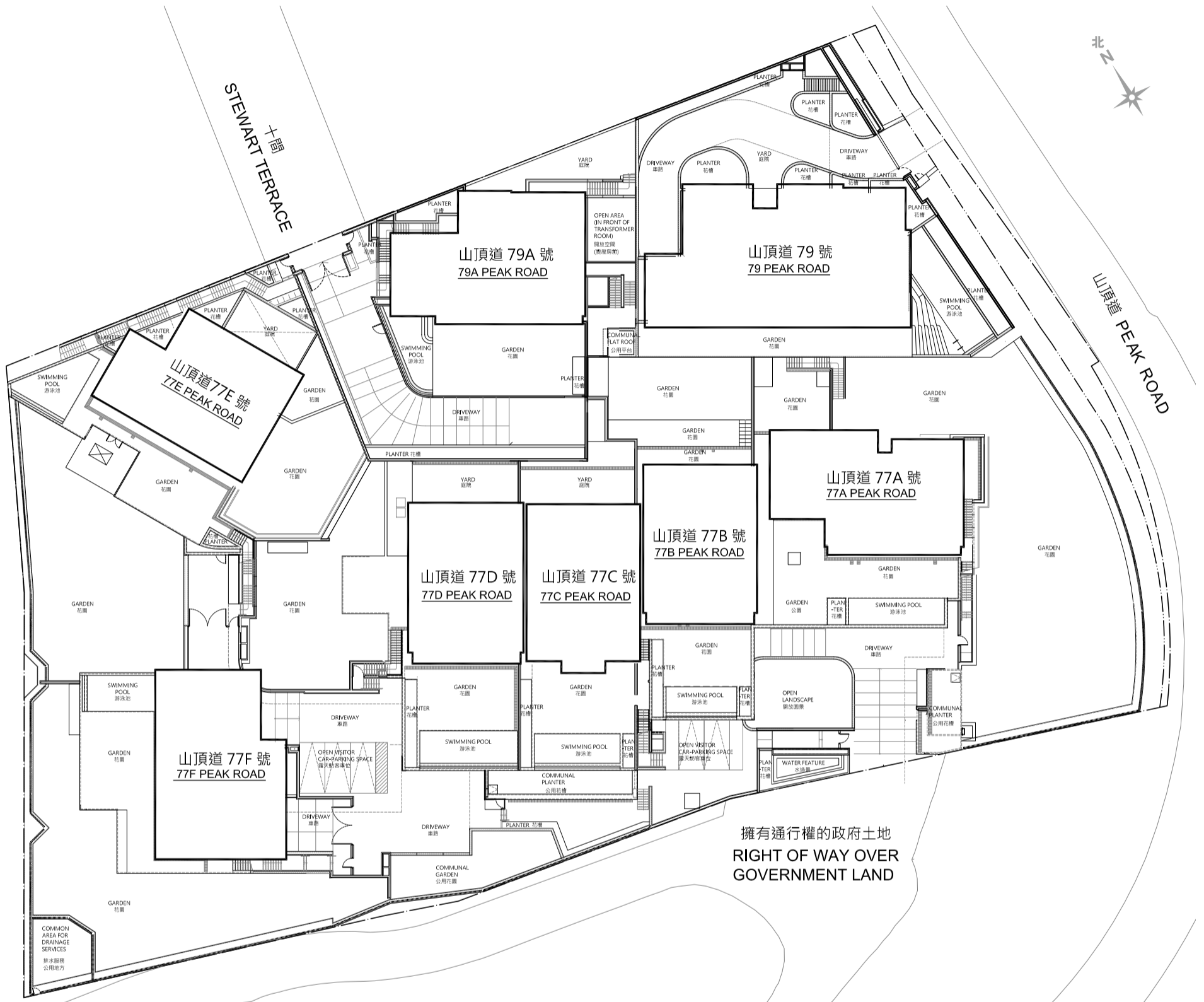

Scale: 0 m(米) 10 m(米)
比例:

— — Boundary line of Development
發展項目的邊界

Notes:

This plan shows the layout of the Development from an aerial view only. The boundaries and areas of the Development on different floors could be different from those shown here.

備註:

本圖僅顯示從上空鳥瞰可見之發展項目佈局。發展項目於不同樓層上的邊界和範圍可能與本圖所示者不同。

Legend of Terms and Abbreviations used on Floor Plans
平面圖中所使用名詞及簡稱之圖例

A/C Plant Rm. = Air-conditioning Plant Room	空調機房
Adjoining Building	毗鄰大廈
Adjoining House	毗鄰獨立屋
Balcony	露台
Bathroom 1/2/3/4/5	浴室 1/2/3/4/5
Canopy	簷篷
Carpark	停車場
Common Staircase	公用樓梯
Common External Staircase	公用外置樓梯
Common Area	公用地方
Corridor	走廊
Dining Room	飯廳
DN = Down	向下
Dressing Room	衣帽間
E.L. Rm = Electrical Room	電錶房
Elevator	升降機
Entrance Canopy	入口簷篷
Entrance Lobby	大堂入口
Ensuite	套房
Ensuite 1/2/3/4/5	套房 1/2/3/4/5
E&M Floor = Electrical and Mechanical Floor	機電層
Family Room	起居室
F.H. = Fire Hydrant	消防柱
Fill	回填
Filtration Plant Rm. = Filtration Plant Room	泳池濾水泵房
Flat Roof	平台
Flush Water Pump Rm. = Flush Water Pump Room	沖廁水泵房
Foyer	前廳
F.S. INLET = Fire Services Inlet	消防入水掣
F.S. Pump Rm. = Fire Services Pump Room	消防泵房
F.S. and Sprinkler Water Pump Rm.= Fire Services and Sprinkler Water Pump Room	消防泵及消防花灑水泵房
F.S. Sprinkler Water Tank	消防花灑水缸
F.S. Water Tank = Fire Services Water Tank	消防水缸
Garage Door	車庫門
Garden	花園
Gas Heater Cabinet	煤氣熱水爐櫃
Her Bathroom	女主人浴室
Her Dressing = Her Dressing Room	女主人衣帽間
His Bathroom	男主人浴室
His Dressing = His Dressing Room	男主人衣帽間
H.R. = Hose Reel	消防喉轆

Note applicable to this section:

Floor-to-floor height: refer to the height between the top surface of the structural slab of the floor and the top surface of the structural slab of its immediate upper floor.

本節適用之備註：

層與層之間的高度：指該樓層之石屎地台面與上一層石屎地台面之高度距離。

Legend of Terms and Abbreviations used on Floor Plans
平面圖中所使用名詞及簡稱之圖例

Kitchen	廚房
Library	書房
Lift Supervisory Panel	升降機監控板
Living Room	客廳
Lobby	大堂
Master Bathroom	主人浴室
Master Ensuite	主人套房
Metal A/C Platform = Metal Air-conditioner Platform	金屬空調機平台
Metal Cladding	金屬層
Open Court Entrance	開放庭入口
Open Landscape Stair	開放式園林樓梯
Pantry	茶水間
P.D. = Pipe Duct	管槽
Pitch Roof	斜屋頂
Planter	花槽
Potable and Flush Water Pump Rm. = Potable and Flushing Water Pump Room	食水及沖廁水泵房
Potable Water Pump Rm. = Potable Water Pump Room	食水泵房
Ramp Up	汽車斜道向上
R.C. A/C Plinth = Reinforced Concrete Air-conditioner Plinth	鋼筋混凝土空調機底座
Restroom	洗手間
Roof	天台
Roof Top of Common Lift	公用升降機天台
S.I. = Sprinkler Inlet	消防花灑入水掣
Sprinkler Water Pump Rm. = Sprinkler Water Pump Room	消防花灑水泵房
Sprinkler Water Tank	消防花灑水缸
Stewart Terrace	十間
Store Room	儲物室
Study Room	書房
Swimming Pool	游泳池
T.B.E. Rm. = Telecommunication Broadcast Equipment Room	電訊及廣播設備機房
T.G. Cabinet = Town Gas Cabinet	煤氣錶箱
Top Roof	頂層天台
Unexcavated	未經挖掘
Up	向上
Void	中空
Void Above Yard	庭院上的中空
Water Feature	水造景
Water Meter	水錶箱掣
W.M.C. = Water Meter Cabinet	水錶箱掣箱
Yard	庭院

Note applicable to this section:

Floor-to-floor height: refer to the height between the top surface of the structural slab of the floor and the top surface of the structural slab of its immediate upper floor.

本節適用之備註：

層與層之間的高度：指該樓層之石屎地台面與上一層石屎地台面之高度距離。

79 Peak Road - 山頂道79號#

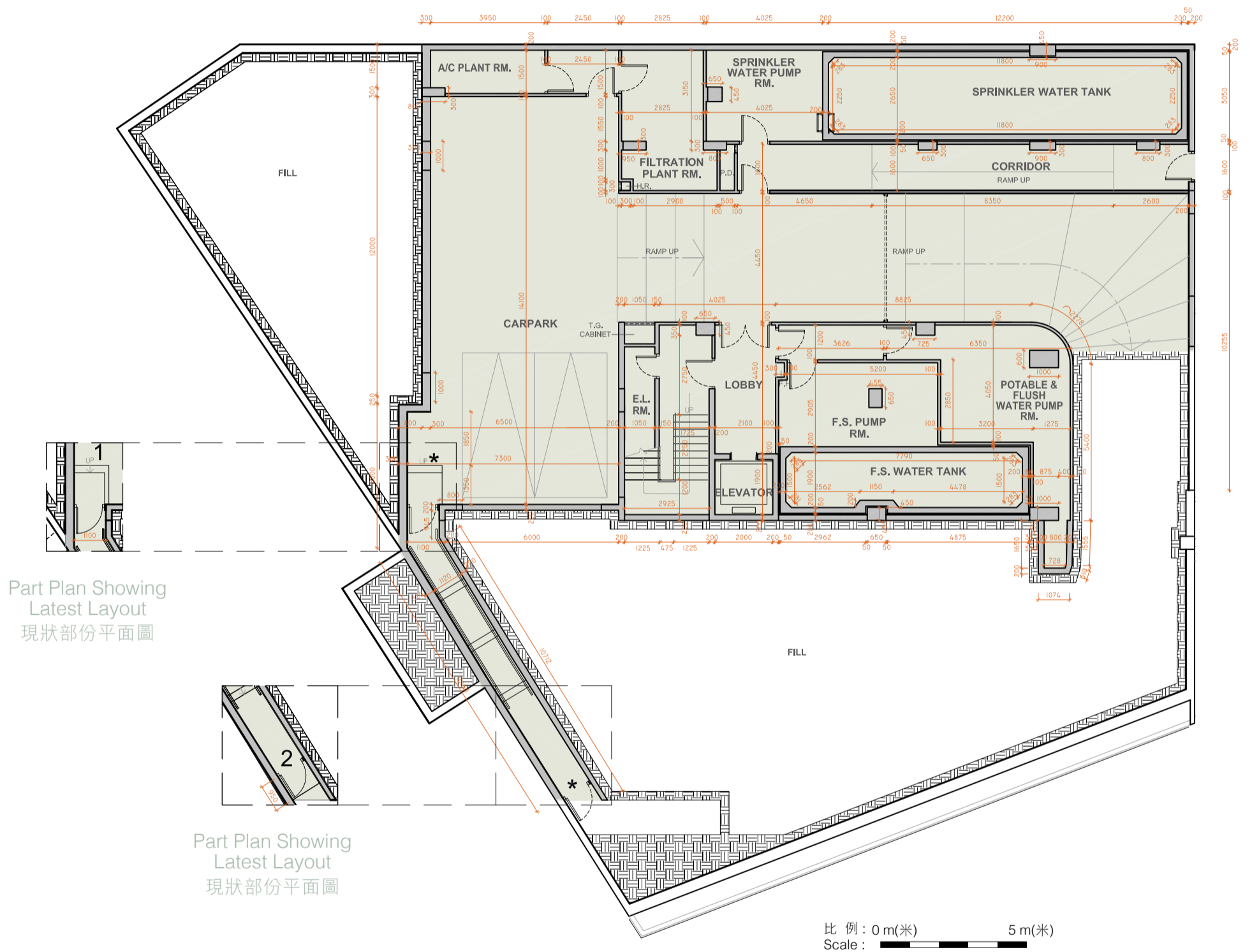

Part Plan Showing Latest Layout
現狀部份平面圖

Part Plan Showing Latest Layout
現狀部份平面圖

Ground Floor Plan (Carpark)
地下平面圖 (停車場)

* This part of layout has been altered by way of minor works or exempted building works under the Buildings Ordinance after completion of the Development, the latest condition of which is shown on the relevant part plan.

The alteration works are as follows:

1. Steps layout has been amended.
2. Door at corridor has been shifted.

The above residential property is/was owned by Affluent Peak Limited. The shares of the holding company of the said company have been transferred and the said company has no longer been associated corporation of Wharf Peak Properties Limited. Floor plans of the above property set out in this sales brochure are based on the plans as at the date of the transfer.

* 此部份因在發展項目落成後進行小型工程或獲《建築物條例》豁免的工程而有所改動，現狀請參考有關部份平面圖。

該等改動如下：

1. 梯級局改動。
2. 走廊門移位。

上述住宅物業由Affluent Peak Limited擁有。該公司的控權公司的股份已轉讓，該公司不再是Wharf Peak Properties Limited的有聯繫法團。本售樓說明書所載上述物業的樓面平面圖乃以轉讓日期的圖則為準。

79 Peak Road - 山頂道79號

Part Plan Showing Latest Layout
現狀部份平面圖

Part Plan Showing Latest Layout
現狀部份平面圖

Part Plan Showing Latest Layout
現狀部份平面圖

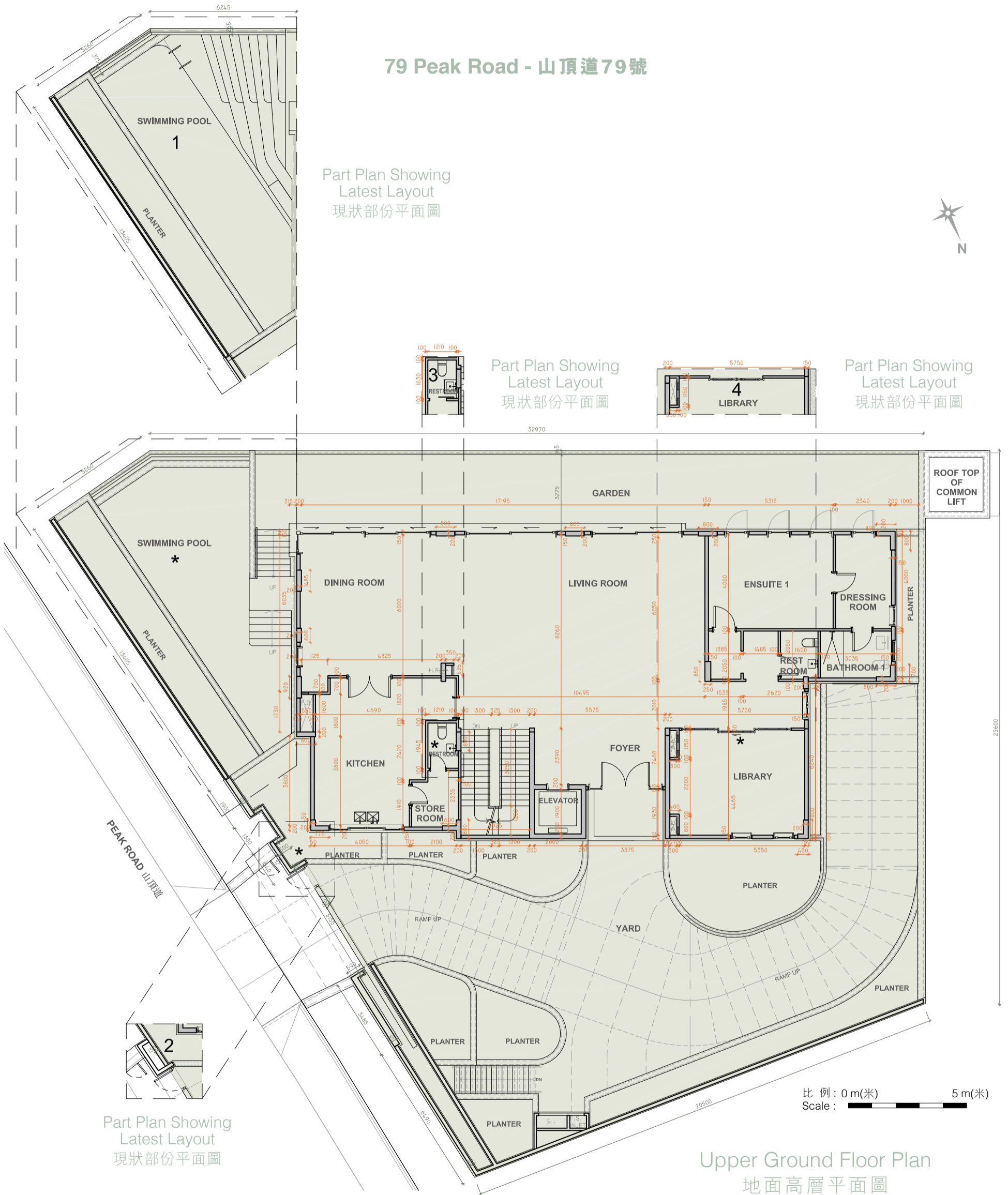

Part Plan Showing Latest Layout
現狀部份平面圖

Upper Ground Floor Plan
地面高層平面圖

* This part of layout has been altered by way of minor works or exempted building works under the Buildings Ordinance after completion of the Development, the latest condition of which is shown on the relevant part plan.

The alteration works are as follows:

1. Swimming pool layout has been amended.
2. Fence wall layout has been amended.
3. Non-structural wall at Restroom has been shifted and the swing door changed to sliding door.
4. Single sliding door at Library changed to double sliding door.

* 此部份因在發展項目落成後進行小型工程或獲《建築物條例》豁免的工程而有所改動，現狀請參考有關部份平面圖。

該等改動如下：

1. 游泳池佈局改動。
2. 圍牆佈局改動。
3. 洗手間非結構牆移位和單扇門改為滑動門。
4. 書房單滑動門改為雙滑動門。

79 Peak Road - 山頂道79號

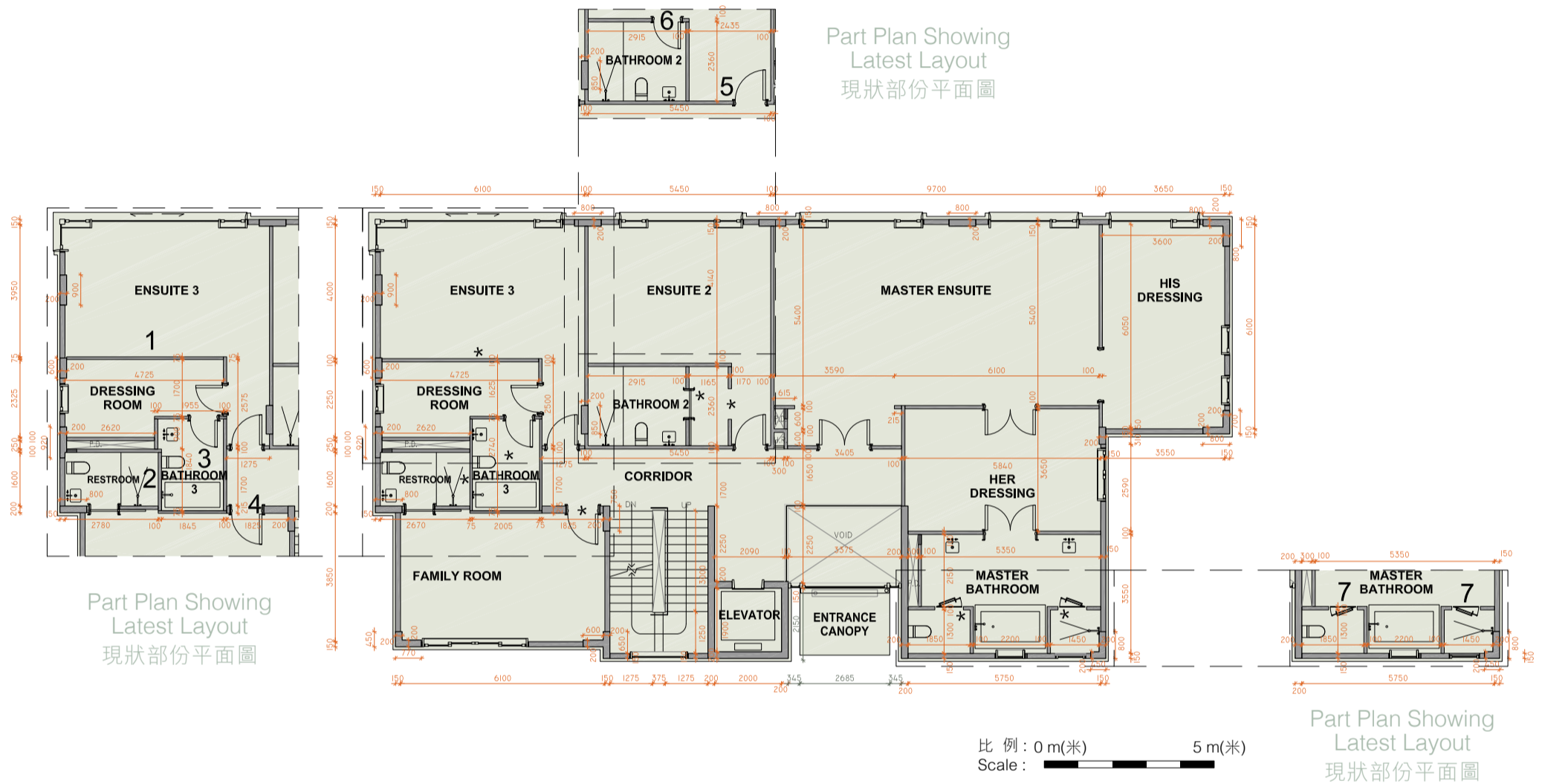

First Floor Plan 一樓平面圖

* This part of layout has been altered by way of minor works or exempted building works under the Buildings Ordinance after completion of the Development, the latest condition of which is shown on the relevant part plan.

The alteration works are as follows:

1. Non-structural wall between Ensuite 3 and Dressing Room has been shifted.
2. Non-structural wall between Restroom and Bathroom 3 has been shifted.
3. Bathroom 3 layout has been amended.
4. Door at Family Room has been shifted.
5. Non-structural wall at Bathroom 2 has been omitted.
6. Door location for Bathroom 2 has been changed.
7. Direction of glass door within Master Bathroom has been amended.

* 此部份因在發展項目落成後進行小型工程或獲《建築物條例》豁免的工程而有所改動，現狀請參考有關部份平面圖。

該等改動如下：

1. 套房3與衣帽間之間的非結構牆移位。
2. 洗手間與浴室3之間的非結構牆移位。
3. 浴室3佈局改動。
4. 起居室內門移位。
5. 浴室2非結構牆移除。
6. 浴室2門位置更改。
7. 主人浴室內玻璃門方向改動。

79 Peak Road - 山頂道79號

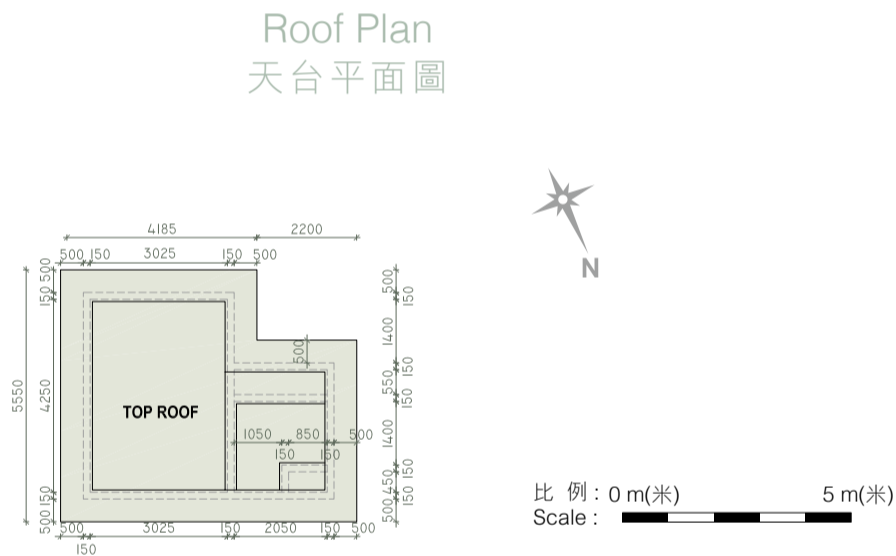
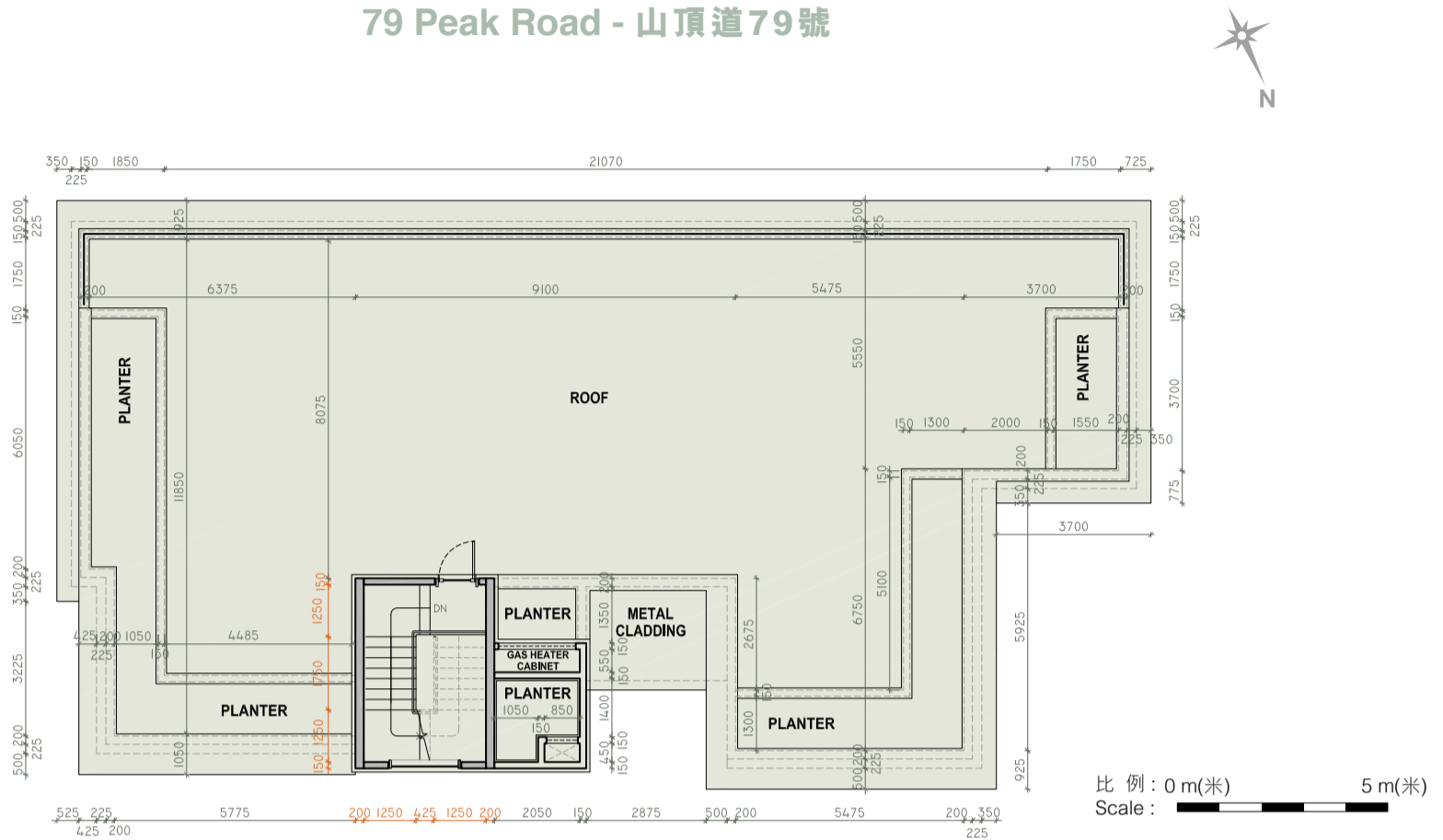

Notes :

- The internal areas of the residential properties on the upper floors will generally be slightly larger than those on the lower floors because of the reducing thickness of the structural walls on the upper floors.
- The dimensions in the floor plans are all structural dimensions in millimetre.

備註：

- 因住宅物業的較高樓層的結構牆的厚度遞減，較高樓層的內部面積，一般比較低樓層的內部面積稍大。
- 樓面平面圖所列之尺寸為以毫米標示之建築結構尺寸。

79 Peak Road - 山頂道79號	Ground Floor 地下	Upper Ground Floor 地面高層	First Floor 一樓	Roof 天台
The floor-to-floor height of the residential property (mm) 住宅物業的層與層之間的高度(毫米)	3700	4210, 4450, 4500, 4510, 4550, 4750, 4800	3500, 3550, 3790	-
The thickness of the floor slabs (excluding plaster) of the residential property (mm) 住宅物業的樓板(不包括灰泥)的厚度(毫米)	150, 175, 200	150, 190, 250	150, 175, 190, 250	-

79A Peak Road - 山頂道79A號#

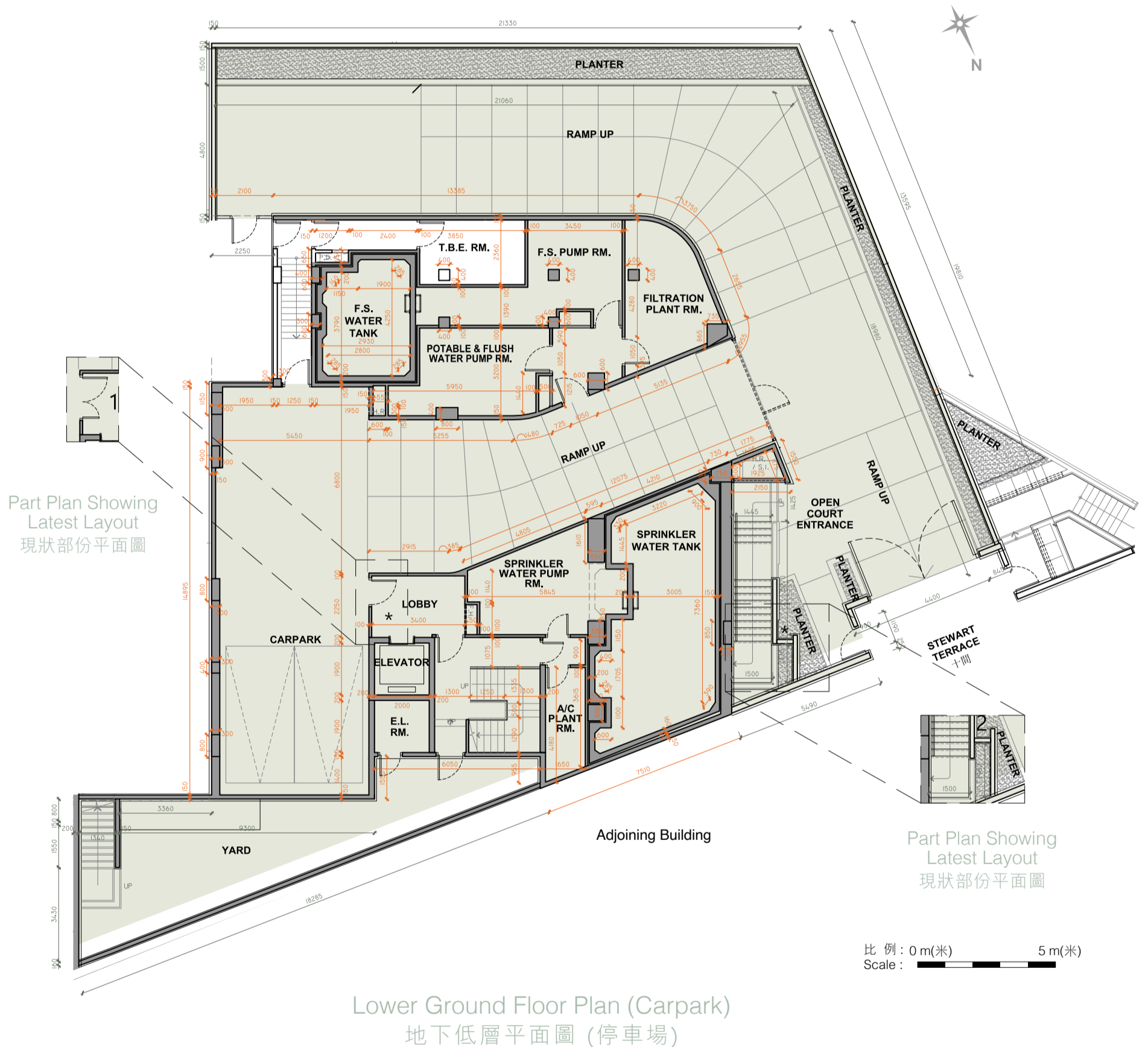

Lower Ground Floor Plan (Carpark)
 地下低層平面圖 (停車場)

* This part of layout has been altered by way of minor works or exempted building works under the Buildings Ordinance after completion of the Development, the latest condition of which is shown on the relevant part plan.

The alteration works are as follows:

1. Single-leaf door at carpark Lift Lobby has been changed to double-leaf door.
2. Parapet wall layout has been amended.

The above residential property is/was owned by Deluxe Achieve Limited. The shares of the holding company of the said company have been transferred and the said company has no longer been associated corporation of Wharf Peak Properties Limited. Floor plans of the above property set out in this sales brochure are based on the plans as at the date of the transfer.

* 此部份因在發展項目落成後進行小型工程或獲《建築物條例》豁免的工程而有所改動，現狀請參考有關部份平面圖。

該等改動如下：

1. 停車場升降機大堂的單扇門更改為雙扇門。
2. 圍牆布局改動。

上述住宅物業由Deluxe Achieve Limited擁有。該公司的控股公司的股份已轉讓，該公司不再是Wharf Peak Properties Limited的有聯繫法團。本售樓說明書所載上述物業的樓面平面圖乃以轉讓日期的圖則為準。

79A Peak Road - 山頂道79A號

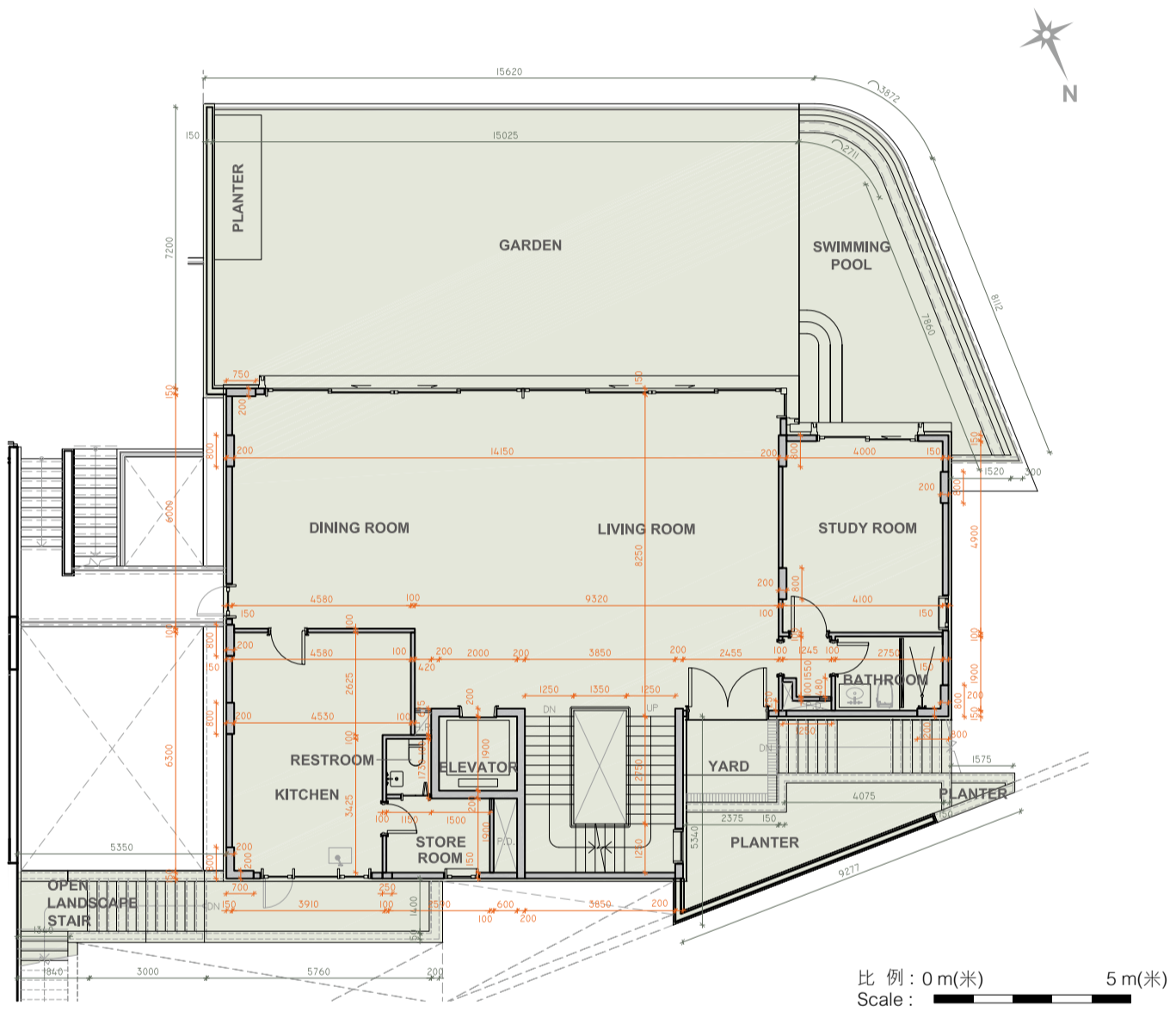

Ground Floor Plan 地下平面圖

79A Peak Road - 山頂道79A號

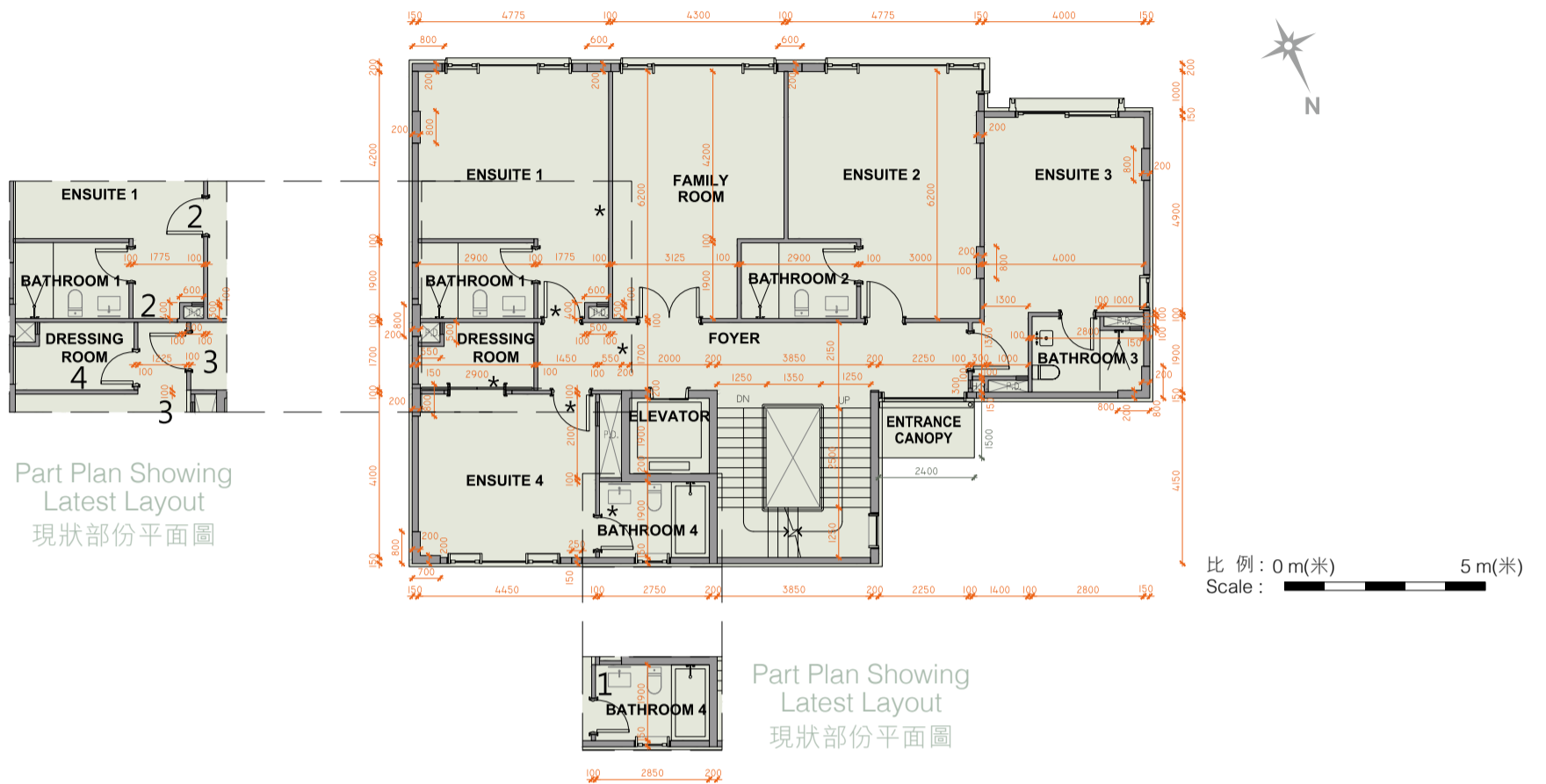

First Floor Plan 一樓平面圖

* This part of layout has been altered by way of minor works or exempted building works under the Buildings Ordinance after completion of the Development, the latest condition of which is shown on the relevant part plan.

The alteration works are as follows:

1. Non-structural wall between Ensuite 4 and Bathroom 4 has been shifted slightly.
2. Door at Ensuite 1 has been relocated.
3. Door at Ensuite 4 has been relocated.
4. Double Sliding Door at Dressing room 4 has been changed to single-leaf door.

* 此部份因在發展項目落成後進行小型工程或獲《建築物條例》豁免的工程而有所改動，現狀請參考有關部份平面圖。

該等改動如下：

1. 套房4與浴室4之間的非結構牆移位。
2. 套房1門移位。
3. 套房4門移位。
4. 衣帽間4的雙滑動門更改為單扇門。

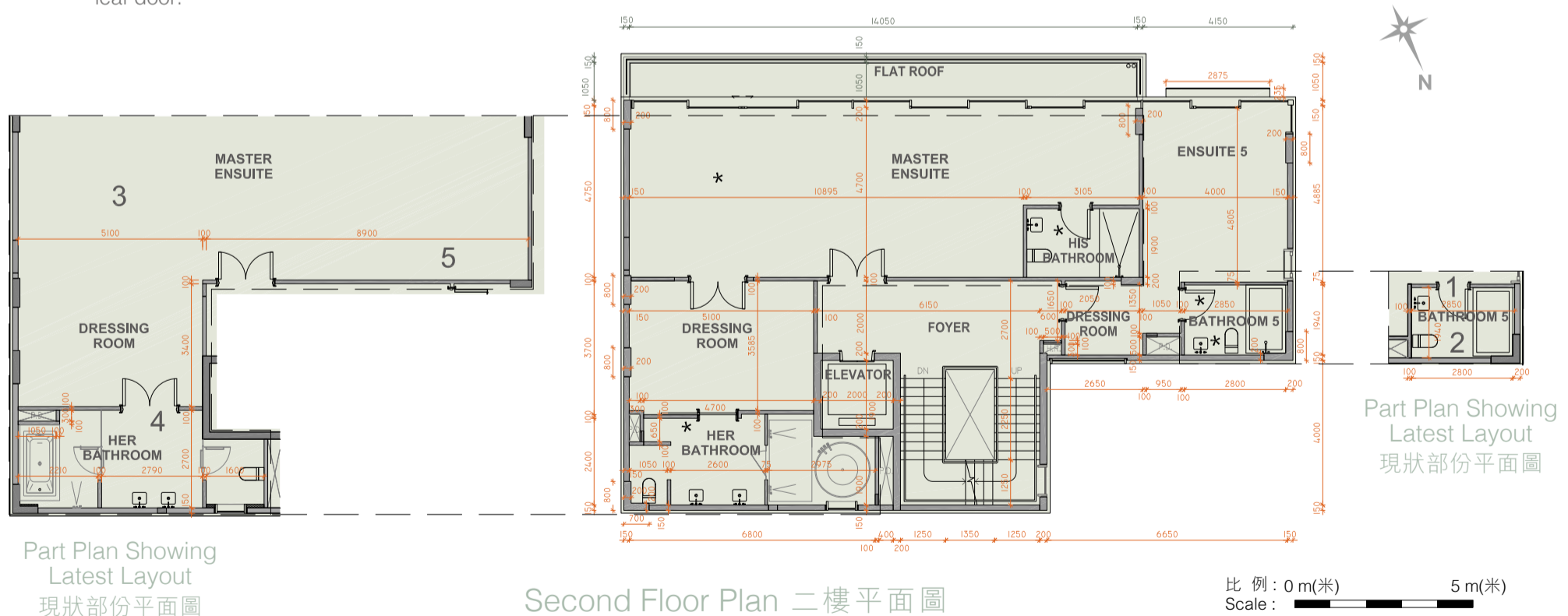

Second Floor Plan 二樓平面圖

* This part of layout has been altered by way of minor works or exempted building works under the Buildings Ordinance after completion of the Development, the latest condition of which is shown on the relevant part plan.

The alteration works are as follows:

1. Door at Bathroom 5 has been relocated.
2. Bathroom 5 layout has been amended.
3. Master Ensuite and Dressing Room layout have been amended.
4. Her Bathroom layout has been amended.
5. His Bathroom has been omitted.

* 此部份因在發展項目落成後進行小型工程或獲《建築物條例》豁免的工程而有所改動，現狀請參考有關部份平面圖。

該等改動如下：

1. 浴室5門移位。
2. 浴室5佈局改動。
3. 主人套房及衣帽間佈局改動。
4. 女主人浴室佈局改動。
5. 男主人浴室移除。

79A Peak Road - 山頂道79A號

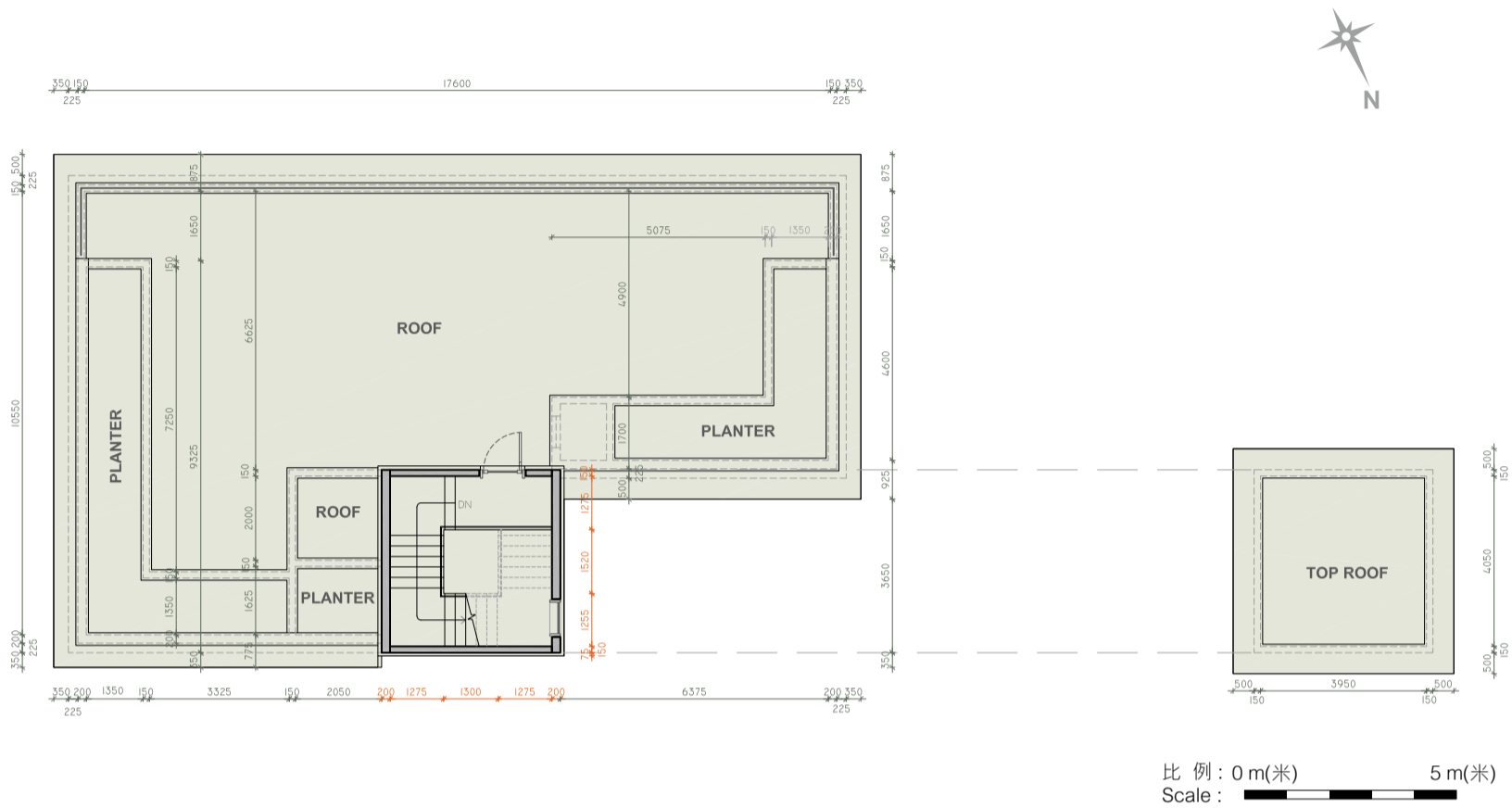

Roof Floor Plan 天台平面圖

Notes :

1. The internal areas of the residential properties on the upper floors will generally be slightly larger than those on the lower floors because of the reducing thickness of the structural walls on the upper floors.
2. The dimensions in the floor plans are all structural dimensions in millimetre.

備註：

1. 因住宅物業的較高樓層的結構牆的厚度遞減，較高樓層的內部面積，一般比較低樓層的內部面積稍大。
2. 樓面平面圖所列之尺寸為以毫米標示之建築結構尺寸。

79A Peak Road - 山頂道79A號	Lower Ground Floor 地下低層	Ground Floor 地下	First Floor 一樓	Second Floor 二樓	Roof 天台
The floor-to-floor height of the residential property (mm) 住宅物業的層與層之間的高度(毫米)	3950	4450, 4500, 4550, 4750	3200, 3220, 3250, 3450, 3500, 3550	3500, 3550, 3780, 3800	-
The thickness of the floor slabs (excluding plaster) of the residential property (mm) 住宅物業的樓板(不包括灰泥)的厚度(毫米)	150, 200, 250, 350	150, 180, 250	150, 180, 250	150, 180, 200	-

77A Peak Road - 山頂道77A號

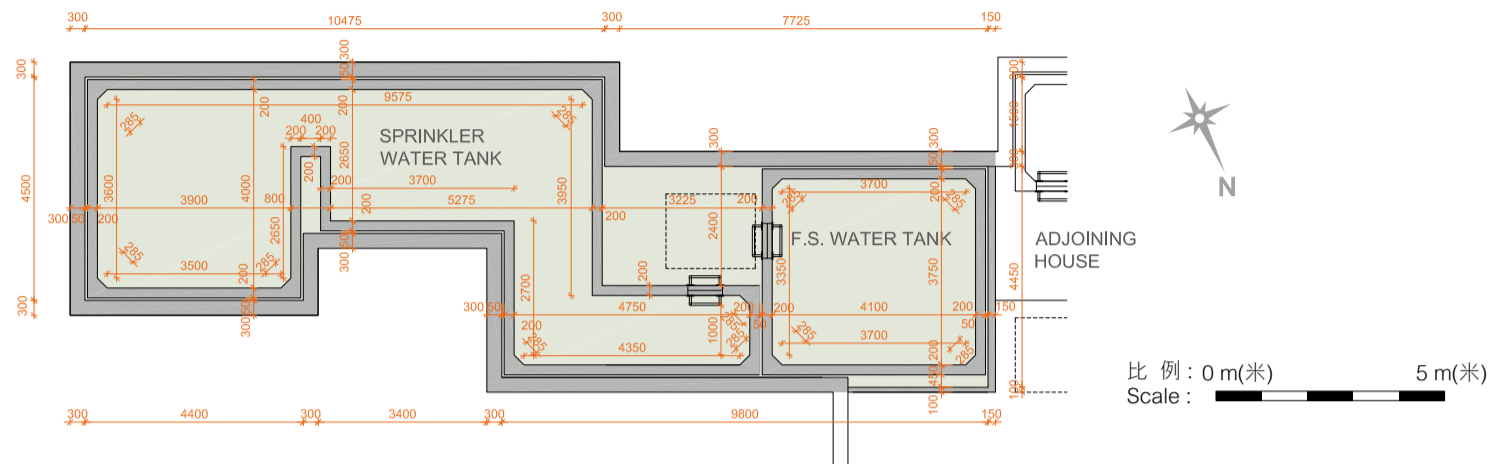

Electrical and Mechanical Floor Plan (Below Lower Ground)
機電層平面圖 (低於地下低層)

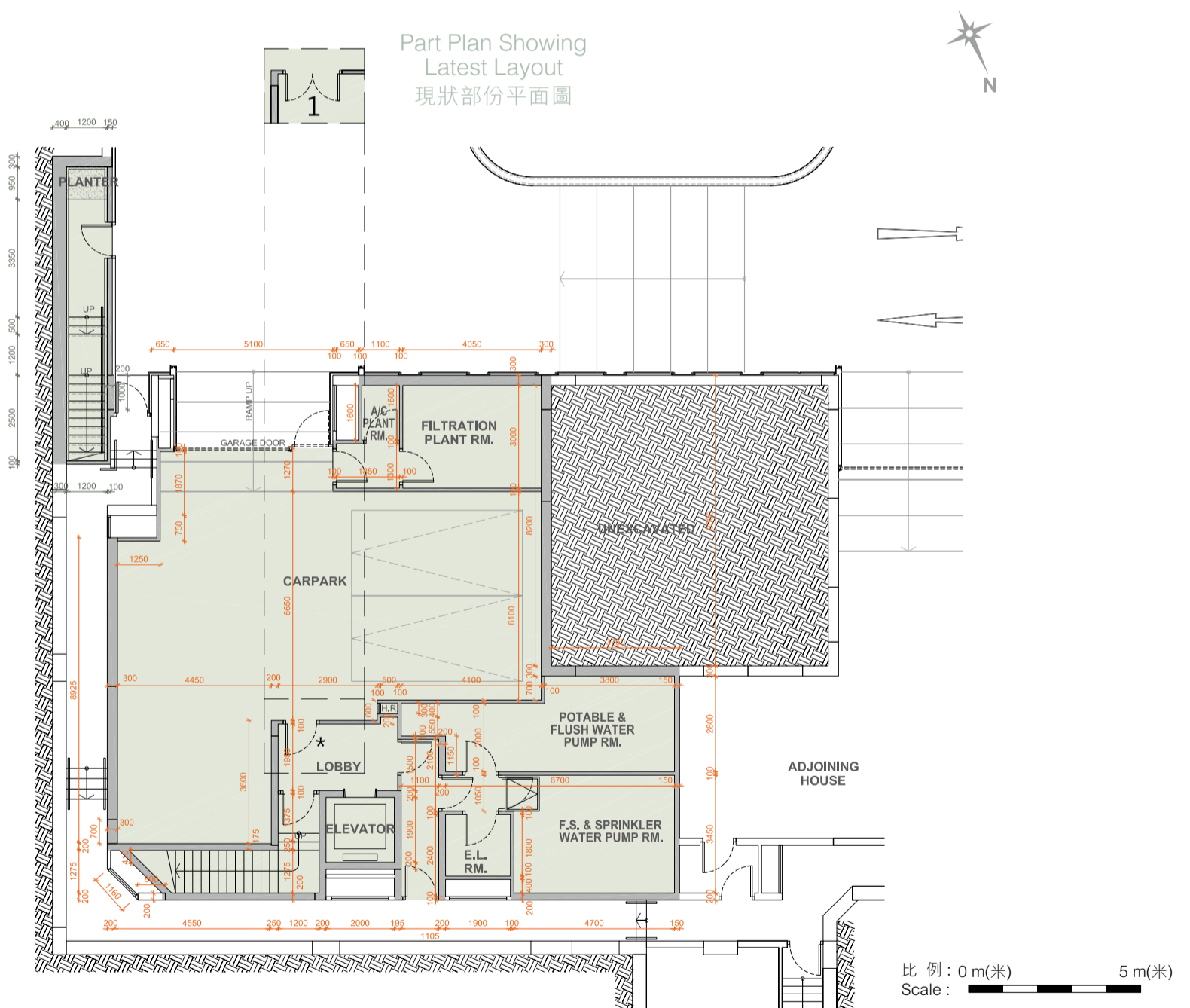

Lower Ground Floor Plan (Carpark)
地下低層平面圖 (停車場)

* This part of layout has been altered by way of minor works or exempted building works under the Buildings Ordinance after completion of the Development, the latest condition of which is shown on the relevant part plan.

The alteration works are as follows:

1. Single-leaf door at carpark Lift Lobby has been changed to double-leaf door.

* 此部份因在發展項目落成後進行小型工程或獲《建築物條例》豁免的工程而有所改動，現狀請參考有關部份平面圖。

該等改動如下：

1. 停車場升降機大堂的單扇門更改為雙扇門。

77A Peak Road - 山頂道77A號

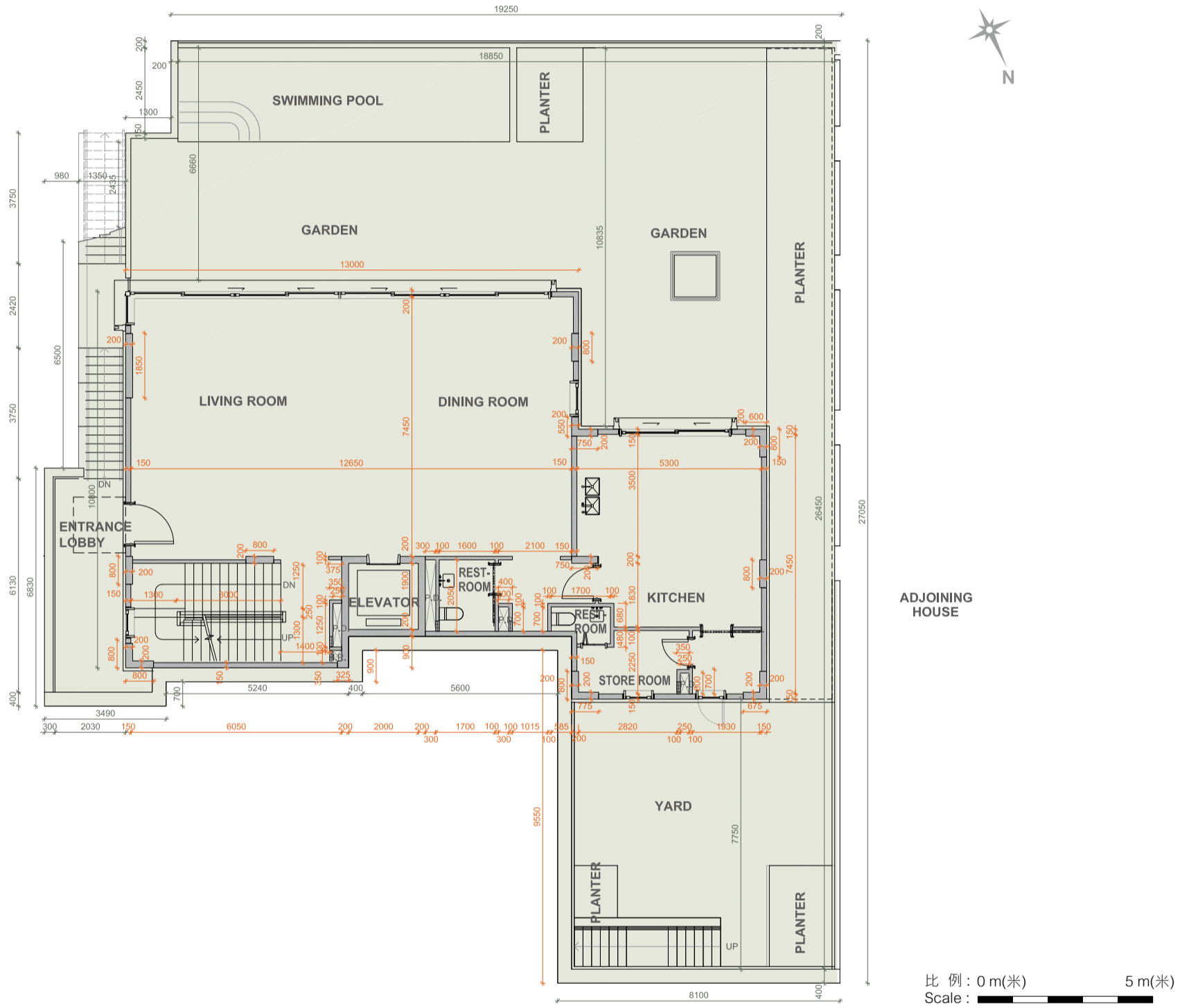

Ground Floor Plan 地下平面圖

77A Peak Road - 山頂道77A號

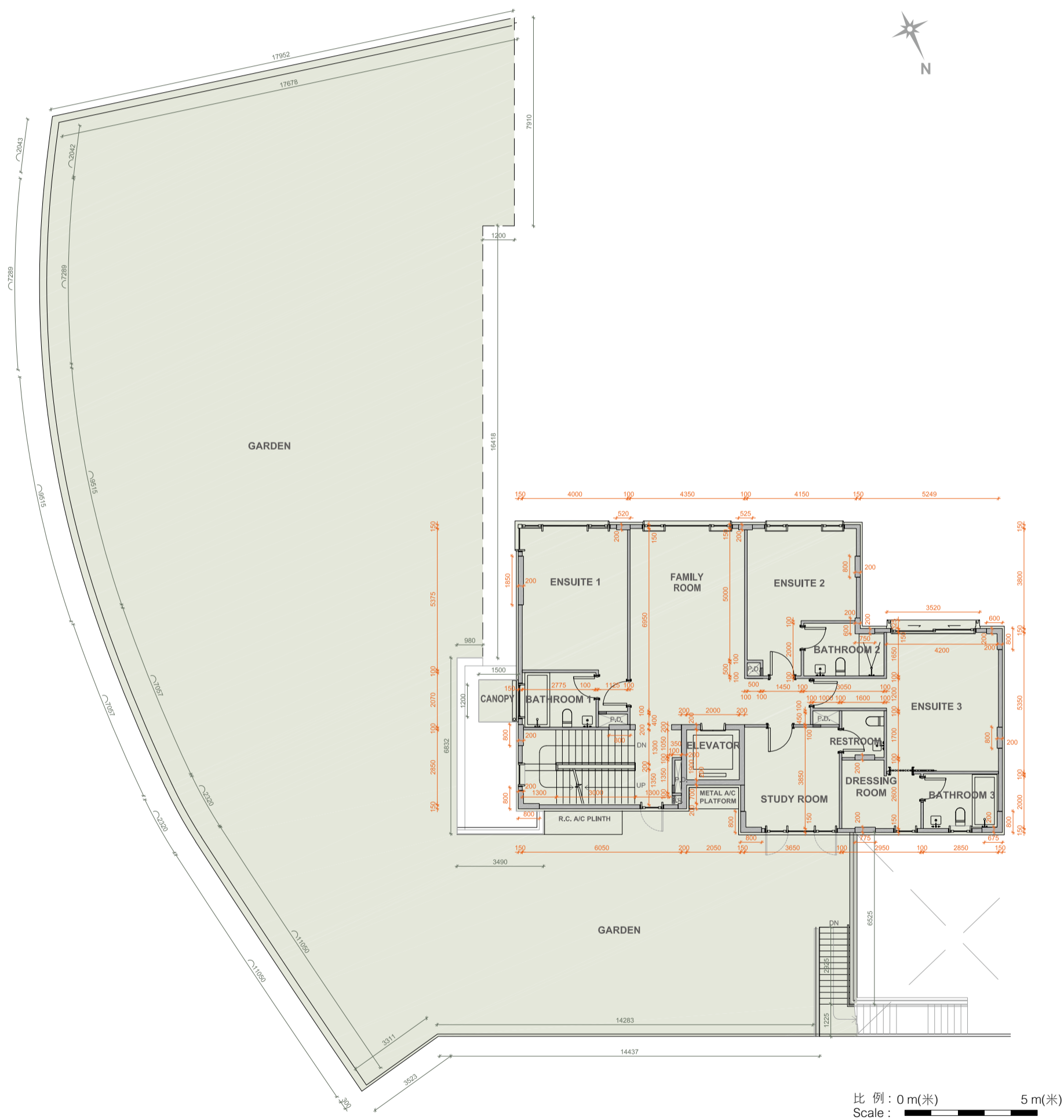

First Floor Plan 一樓平面圖

77A Peak Road - 山頂道77A號

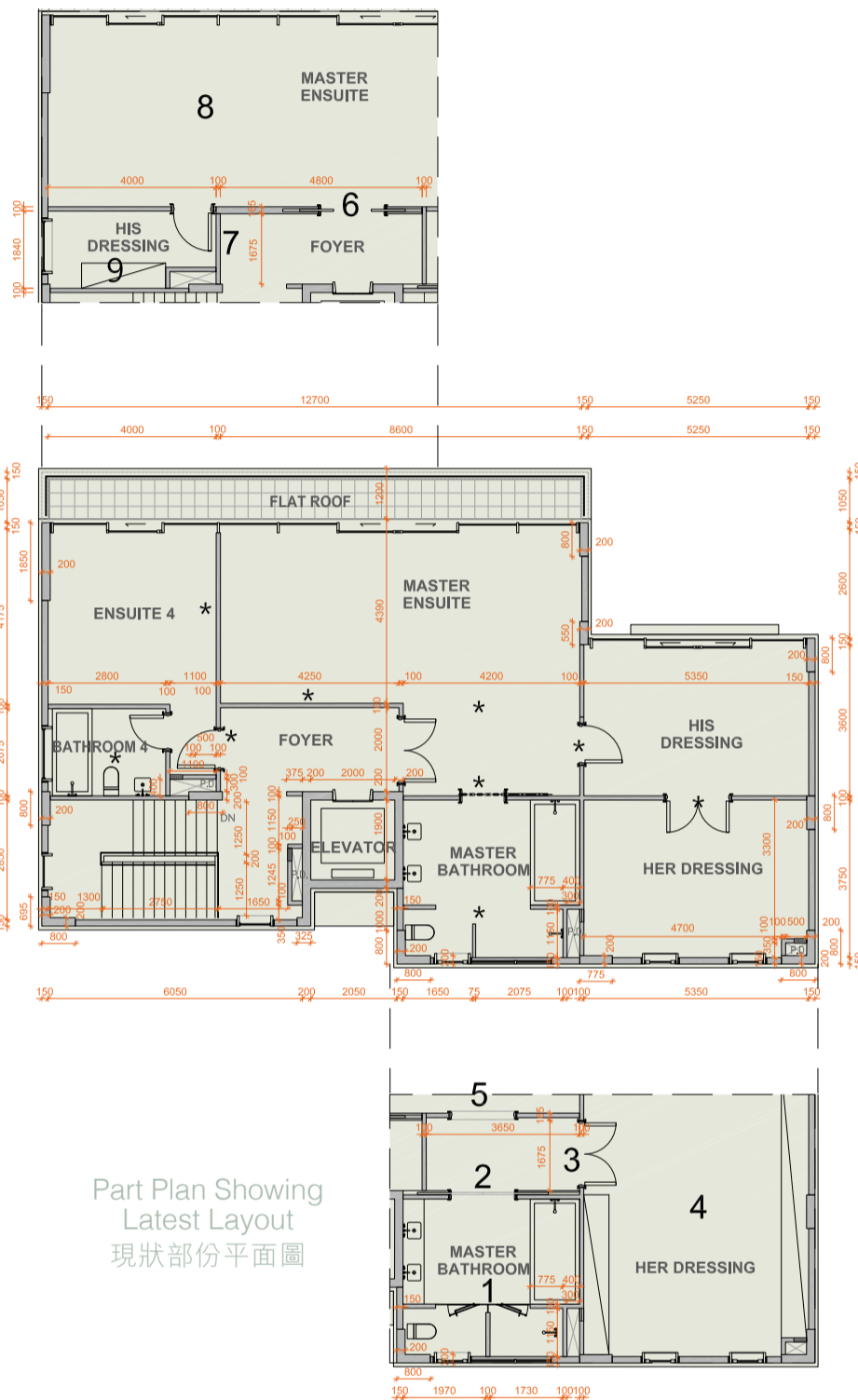
Part Plan Showing
Latest Layout
現狀部份平面圖Part Plan Showing
Latest Layout
現狀部份平面圖

Second Floor Plan 二樓平面圖

* This part of layout has been altered by way of minor works or exempted building works under the Buildings Ordinance after completion of the Development, the latest condition of which is shown on the relevant part plan.

The alteration works are as follows:

1. Partition wall within Master Bathroom has been shifted and glass wall/glass doors have been added.
2. Single sliding door at Master Bathroom has been changed to double sliding door.
3. Single-leaf door at Dressing Room has been changed to double-leaf door.
4. Non-structural wall at Her Dressing Room has been omitted.
5. Non-structural wall has been added to Master Ensuite.
6. Double-leaf door at Master Ensuite has been changed to double sliding door.
7. Master Ensuite layout and door has been amended.
8. Non-structural wall between Master Ensuite and Ensuite 4 has been omitted.
9. Bathroom 4 has been changed to His Dressing Room, layout and door has been amended.

* 此部份因在發展項目落成後進行小型工程或獲《建築物條例》豁免的工程而有所改動，現狀請參考有關部份平面圖。

該等改動如下：

1. 主人浴室內間隔牆移位及新增玻璃牆/玻璃門。
2. 主人浴室的單滑門更改為雙滑門。
3. 衣帽間的單扇門更改為雙扇門。
4. 女主人衣帽間非結構牆移除。
5. 主人套房新增非結構牆。
6. 主人套房雙扇門更改為雙滑門。
7. 主人套房佈局改動及門移位。
8. 主人套房與套房4之間非結構牆移除。
9. 浴室4更改為男主人衣帽間，佈局和門改動。

77A Peak Road - 山頂道77A號

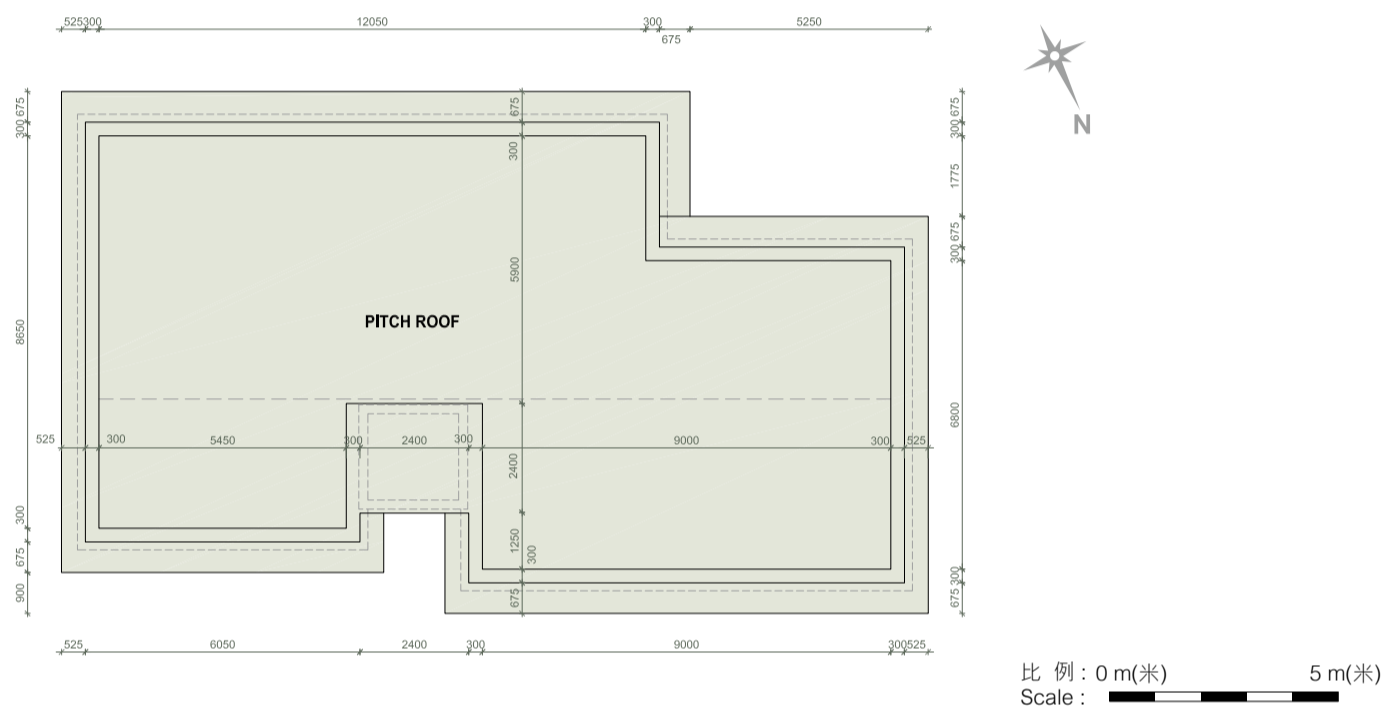

Roof Floor Plan 天台平面圖

Notes :

1. The internal areas of the residential properties on the upper floors will generally be slightly larger than those on the lower floors because of the reducing thickness of the structural walls on the upper floors.
2. The dimensions in the floor plans are all structural dimensions in millimetre.

備註:

1. 因住宅物業的較高樓層的結構牆的厚度遞減，較高樓層的內部面積，一般比較低樓層的內部面積稍大。
2. 樓面平面圖所列之尺寸為以毫米標示之建築結構尺寸。

77A Peak Road - 山頂道77A號	E&M/F 機電層	Lower Ground Floor 地下低層	Ground Floor 地下	First Floor 一樓	Second Floor 二樓	Roof 天台
The floor-to-floor height of the residential property (mm) 住宅物業的層與層之間的高度(毫米)	3270	4750	4200, 4450, 4500	3200, 3450, 3500, 3550	3500 - 4500	-
The thickness of the floor slabs (excluding plaster) of the residential property (mm) 住宅物業的樓板(不包括灰泥)的厚度(毫米)	200	150, 250	150, 200, 275	150, 275	150, 200, 275	-

77B Peak Road - 山頂道77B號

Electrical and Mechanical
Floor Plan (Below Lower Ground)
機電層平面圖 (低於地下低層)

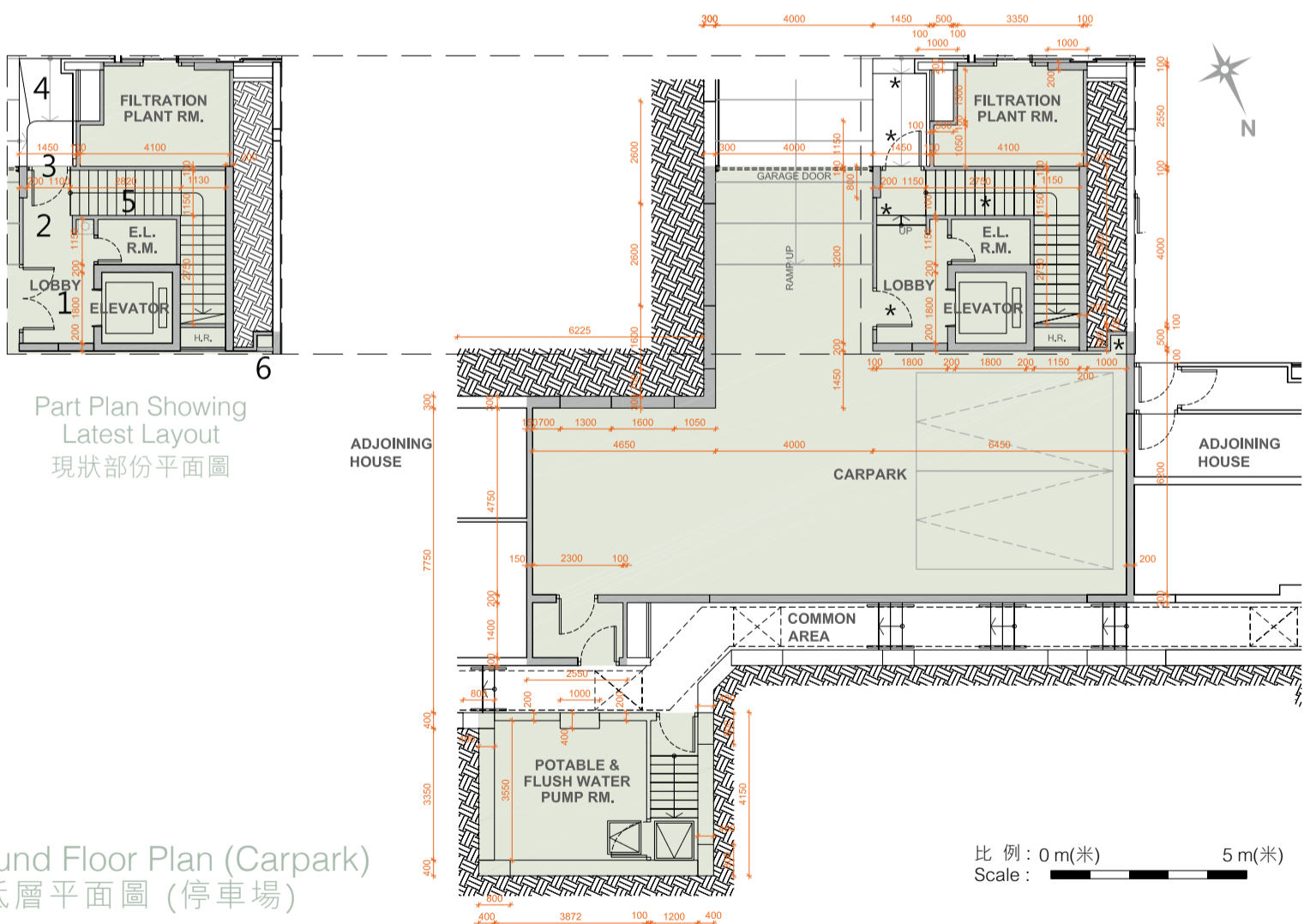
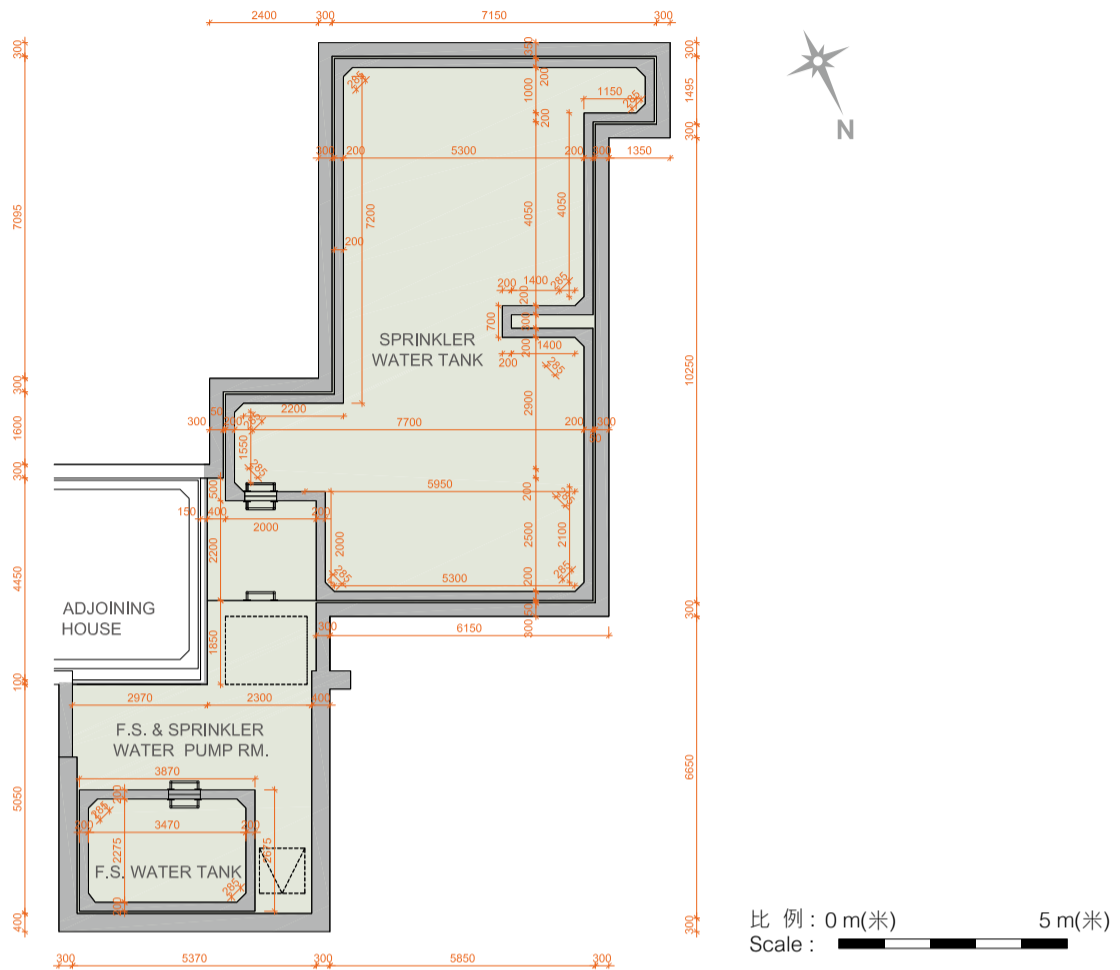

Lower Ground Floor Plan (Carpark)
地下低層平面圖 (停車場)

* This part of layout has been altered by way of minor works or exempted building works under the Buildings Ordinance after completion of the Development, the latest condition of which is shown on the relevant part plan.

The alteration works are as follows:

1. Single-leaf door at carpark Lift Lobby has been changed to double-leaf door.
2. 2 steps have been removed.
3. Lobby door swing direction has been changed.
4. Layout of entrance from driveway to carpark Lift Lobby has been amended.
5. 1 step has been added to the staircase.
6. Layout at carpark has been amended.

* 此部份因在發展項目落成後進行小型工程或獲《建築物條例》豁免的工程而有所改動，現狀請參考有關部份平面圖。

該等改動如下：

1. 停車場升降機大堂的單扇門更改為雙扇門。
2. 兩級梯級移除。
3. 大堂擺門方向改動。
4. 車路入口至停車場升降機大堂佈局改動。
5. 一級梯級增加。
6. 停車場佈局改動。

77B Peak Road - 山頂道77B號



Ground Floor Plan 地下平面圖

比例: 0 m(米) 5 m(米)
Scale: 5 m(米)

* This part of layout has been altered by way of minor works or exempted building works under the Buildings Ordinance after completion of the Development, the latest condition of which is shown on the relevant part plan.

The alteration works are as follows:

1. Kitchen layout has been amended.
2. Restroom has been relocated.
3. Fire hose reel has been relocated.
4. Pipe duct has been relocated.
5. Restroom layout has been amended.

* 此部份因在發展項目落成後進行小型工程或獲《建築物條例》豁免的工程而有所改動，現狀請參考有關部份平面圖。

該等改動如下：

1. 廚房佈局改動。
2. 洗手間移位。
3. 消防喉轆移位。
4. 管槽移位。
5. 洗手間佈局改動。

77B Peak Road - 山頂道77B號



Part Plan Showing Latest Layout
現狀部份平面圖

First Floor Plan 一樓平面圖

* This part of layout has been altered by way of minor works or exempted building works under the Buildings Ordinance after completion of the Development, the latest condition of which is shown on the relevant part plan.

The alteration works are as follows:

1. Door at Ensuite 3 has been relocated.
2. Non-structural wall at Ensuite 3 has been omitted.
3. Ensuite 3 layout has been amended.
4. Door at Ensuite 2 has been relocated.
5. Non-structural wall at Ensuite 2 has been omitted.
6. Ensuite 2 layout has been amended.

* 此部份因在發展項目落成後進行小型工程或獲《建築物條例》豁免的工程而有所改動，現狀請參考有關部份平面圖。

該等改動如下：

1. 套房3門移位。
2. 套房3非結構牆移除。
3. 套房3佈局改動。
4. 套房2門移位。
5. 套房2非結構牆移除。
6. 套房2佈局改動。

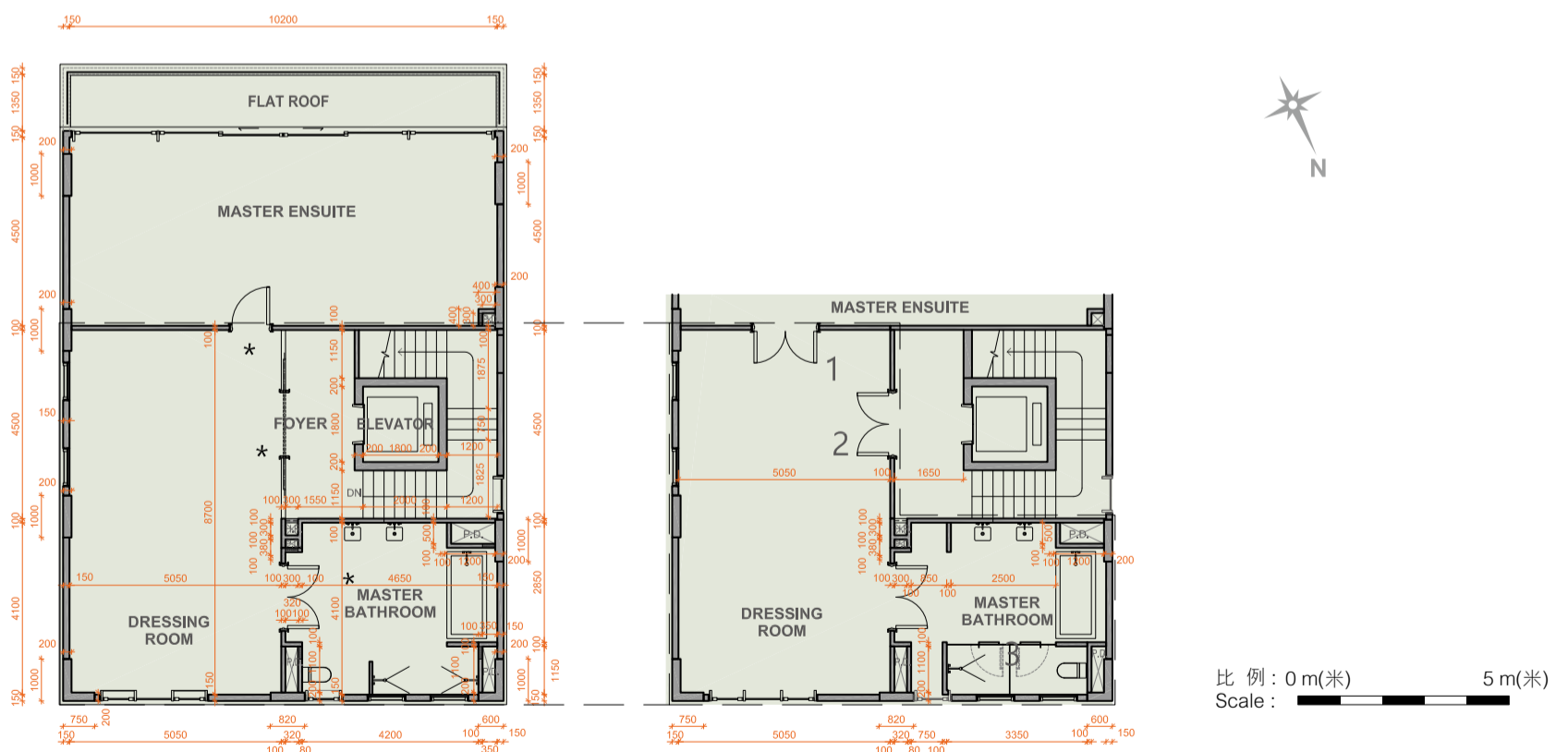

Second Floor Plan 二樓平面圖

* This part of layout has been altered by way of minor works or exempted building works under the Buildings Ordinance after completion of the Development, the latest condition of which is shown on the relevant part plan.

The alteration works are as follows:

1. Single-leaf door at Master Ensuite has been changed to double-leaf door.
2. Glass wall and glass door at Dressing Room have been changed to non-structural wall and double-leaf door.
3. Positions of sanitary fittings within Master Bathroom have been amended.

* 此部份因在發展項目落成後進行小型工程或獲《建築物條例》豁免的工程而有所改動，現狀請參考有關部份平面圖。

該等改動如下：

1. 主人套房的單扇門更改為雙扇門。
2. 衣帽間的玻璃牆及玻璃門更改為非結構牆及雙扇門。
3. 主人浴室內衛浴潔具位置改動。

77B Peak Road - 山頂道77B號

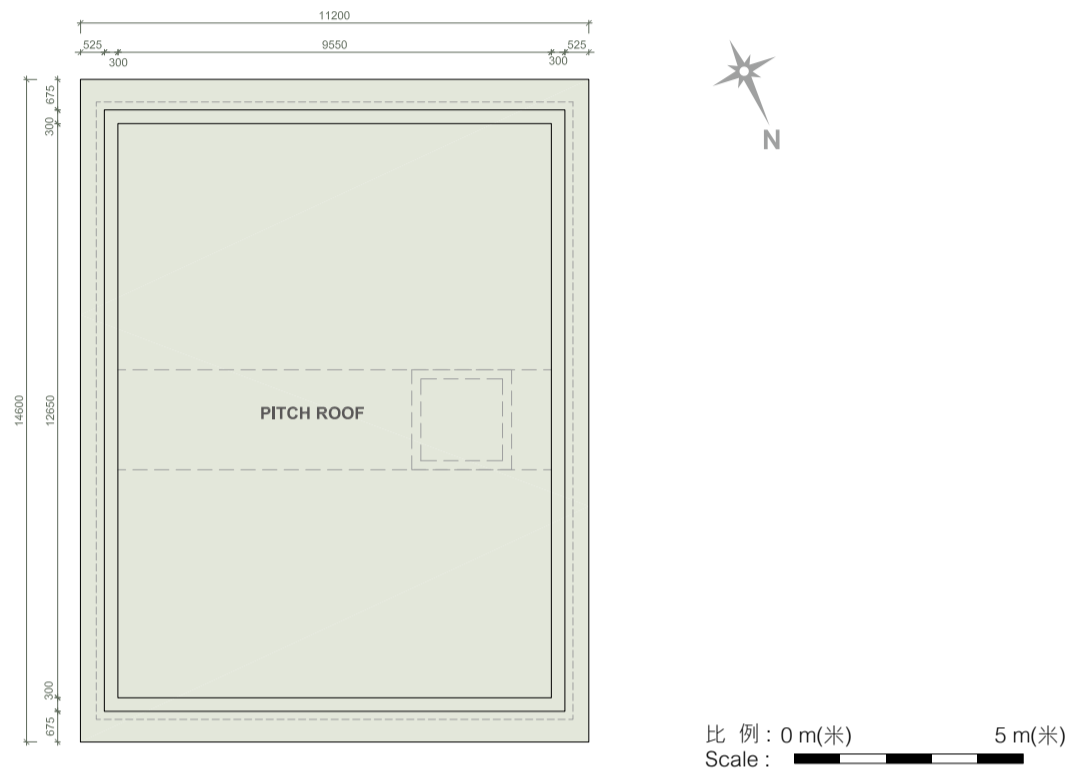

Roof Floor Plan 天台平面圖

Notes :

1. The internal areas of the residential properties on the upper floors will generally be slightly larger than those on the lower floors because of the reducing thickness of the structural walls on the upper floors.
2. The dimensions in the floor plans are all structural dimensions in millimetre.

備註：

1. 因住宅物業的較高樓層的結構牆的厚度遞減，較高樓層的內部面積，一般比較低樓層的內部面積稍大。
2. 樓面平面圖所列之尺寸為以毫米標示之建築結構尺寸。

77B Peak Road - 山頂道77B號	E&M/F 機電層	Lower Ground Floor 地下低層	Ground Floor 地下	First Floor 一樓	Second Floor 二樓	Roof 天台
The floor-to-floor height of the residential property (mm) 住宅物業的層與層之間的高度(毫米)	4220	4750	4450, 4500, 4550	3200, 3250, 3450, 3500, 3550	3500 - 4500	-
The thickness of the floor slabs (excluding plaster) of the residential property (mm) 住宅物業的樓板(不包括灰泥)的厚度(毫米)	200, 225	150, 200	150, 175, 225	150, 225	100, 150, 175	-

77C Peak Road - 山頂道77C號

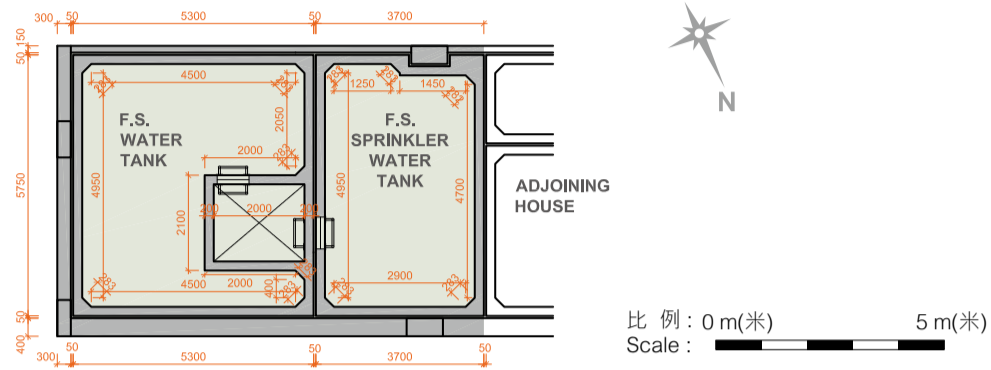

Electrical and Mechanical Floor (Above 1/F)
機電層平面圖 (高於一樓)

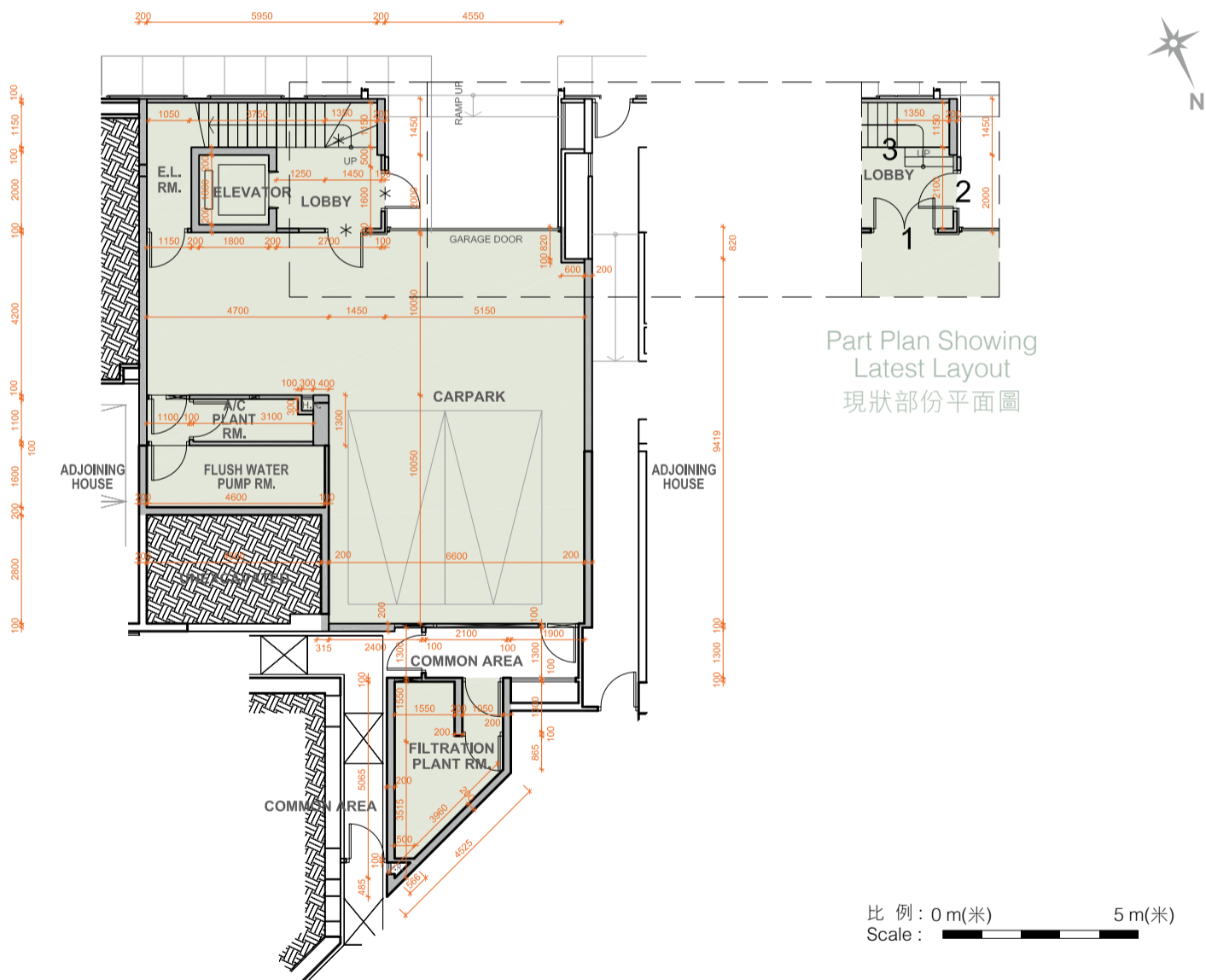

Lower Ground Floor Plan (Carpark)
地下低層平面圖 (停車場)

* This part of layout has been altered by way of minor works or exempted building works under the Buildings Ordinance after completion of the Development, the latest condition of which is shown on the relevant part plan.

The alteration works are as follows:

1. Single-leaf door at carpark Lift Lobby has been changed to double-leaf door.
2. Lobby door swing direction has been changed.
3. Staircase has been modified.

* 此部份因在發展項目落成後進行小型工程或獲《建築物條例》豁免的工程而有所改動，現狀請參考有關部份平面圖。

該等改動如下：

1. 停車場升降機大堂的單扇門更改為雙扇門。
2. 大堂擺門方向改動。
3. 樓梯改動。

77C Peak Road - 山頂道77C號

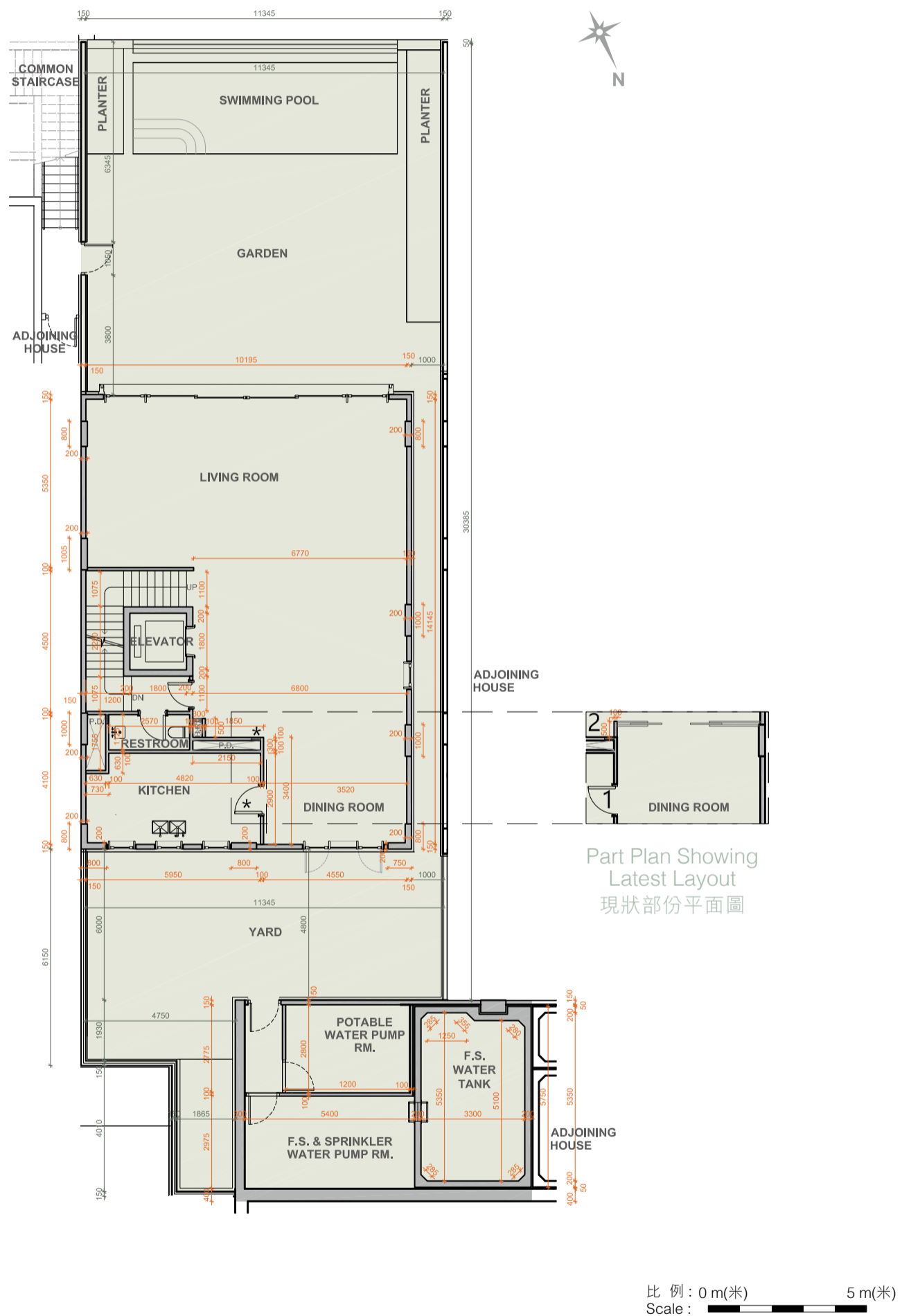

Ground Floor Plan 地下平面圖

* This part of layout has been altered by way of minor works or exempted building works under the Buildings Ordinance after completion of the Development, the latest condition of which is shown on the relevant part plan.

The alteration works are as follows:

1. Kitchen door swing direction has been changed.
2. Dining Room layout has been amended.

* 此部份因在發展項目落成後進行小型工程或獲《建築物條例》豁免的工程而有所改動，現狀請參考有關部份平面圖。

該等改動如下：

1. 廚房擺門方向改動。
2. 飯廳佈局改動。

77C Peak Road - 山頂道77C號

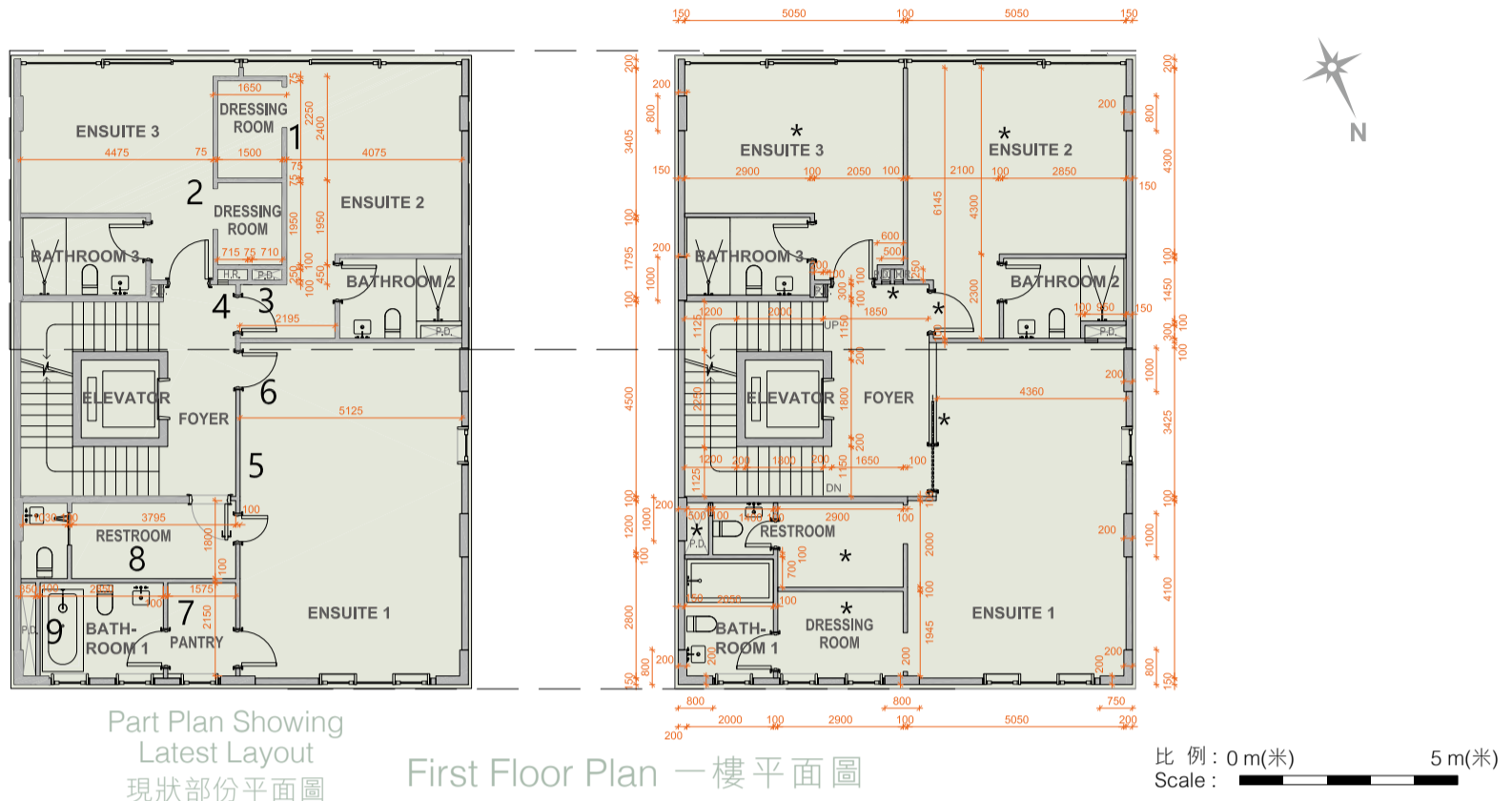

* This part of layout has been altered by way of minor works or exempted building works under the Buildings Ordinance after completion of the Development, the latest condition of which is shown on the relevant part plan.

The alteration works are as follows:

1. Ensuite 2 layout has been amended.
2. Ensuite 3 layout has been amended.
3. Door at Ensuite 2 has been relocated.
4. Fire hose reel and pipe duct layout have been amended.
5. Non-structural wall and door at Ensuite 1 have been relocated.
6. Sliding door at Ensuite 1 has been changed to single swing door.
7. Dressing Room layout has been amended.
8. Restroom layout has been amended.
9. Pipe duct has been relocated.

* 此部份因在發展項目落成後進行小型工程或獲《建築物條例》豁免的工程而有所改動，現狀請參考有關部份平面圖。

該等改動如下：

1. 套房2佈局改動。
2. 套房3佈局改動。
3. 套房2門移位。
4. 消防喉轆，管槽佈局改動。
5. 套房1非結構牆及門移位。
6. 套房1滑動門改為單扇門。
7. 衣帽間佈局改動。
8. 洗手間佈局改動。
9. 管槽佈局移位。

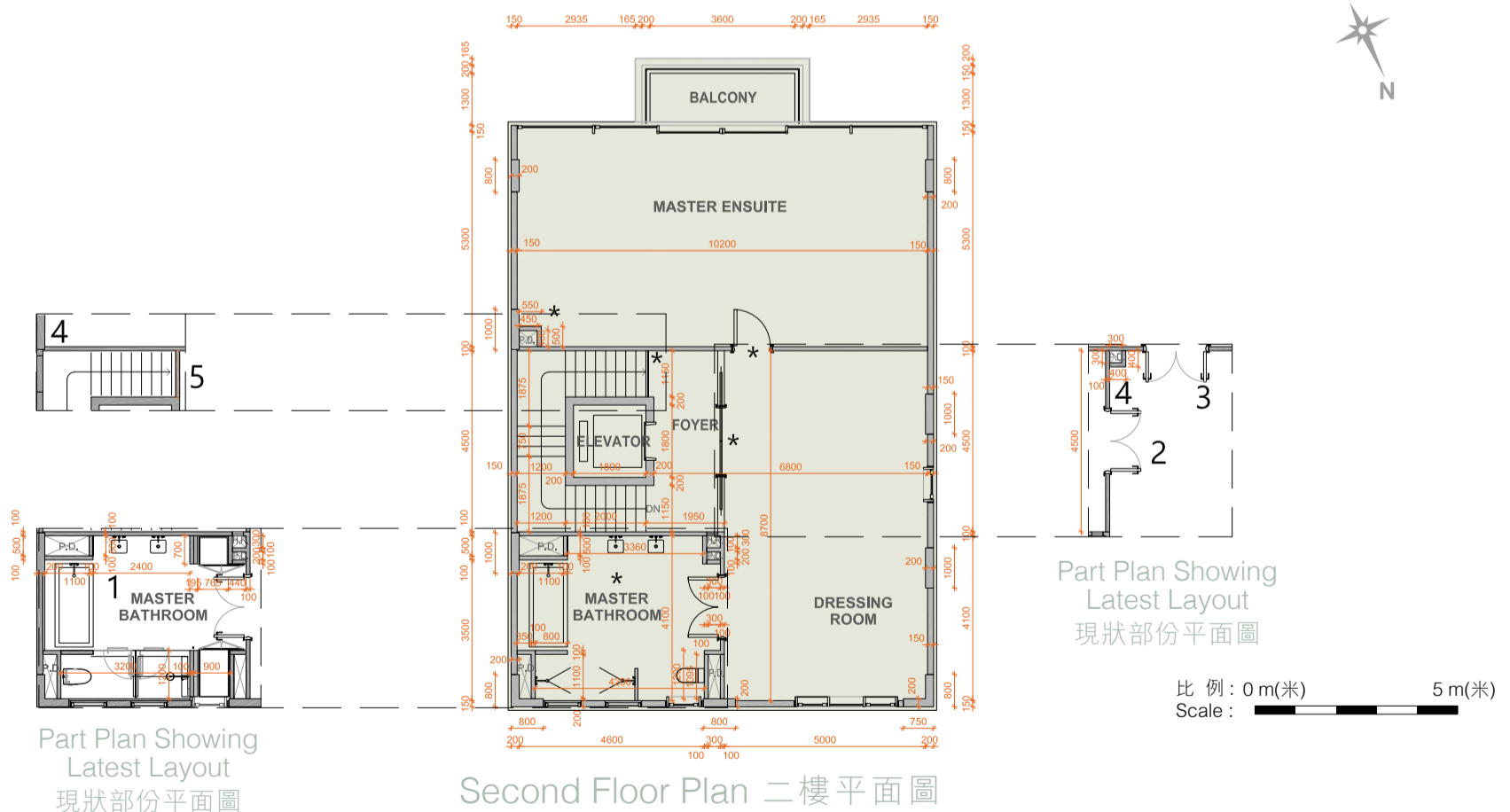

* This part of layout has been altered by way of minor works or exempted building works under the Buildings Ordinance after completion of the Development, the latest condition of which is shown on the relevant part plan.

The alteration works are as follows:

1. Master Bathroom layout has been amended.
2. Glass wall and glass door at Dressing Room have been changed to non-structural wall and double-leaf door.
3. Single door at Master Ensuite has been changed to double swing door and shifted.
4. Pipe duct has been relocated.
5. Non-structural wall has been added to Foyer.

* 此部份因在發展項目落成後進行小型工程或獲《建築物條例》豁免的工程而有所改動，現狀請參考有關部份平面圖。

該等改動如下：

1. 主人浴室佈局改動。
2. 衣帽間的玻璃牆及玻璃門更改為非結構牆及雙扇門。
3. 主人套房單扇門改為雙扇門及移位。
4. 管槽佈局移位。
5. 前廳新增非結構牆。

77C Peak Road - 山頂道77C號

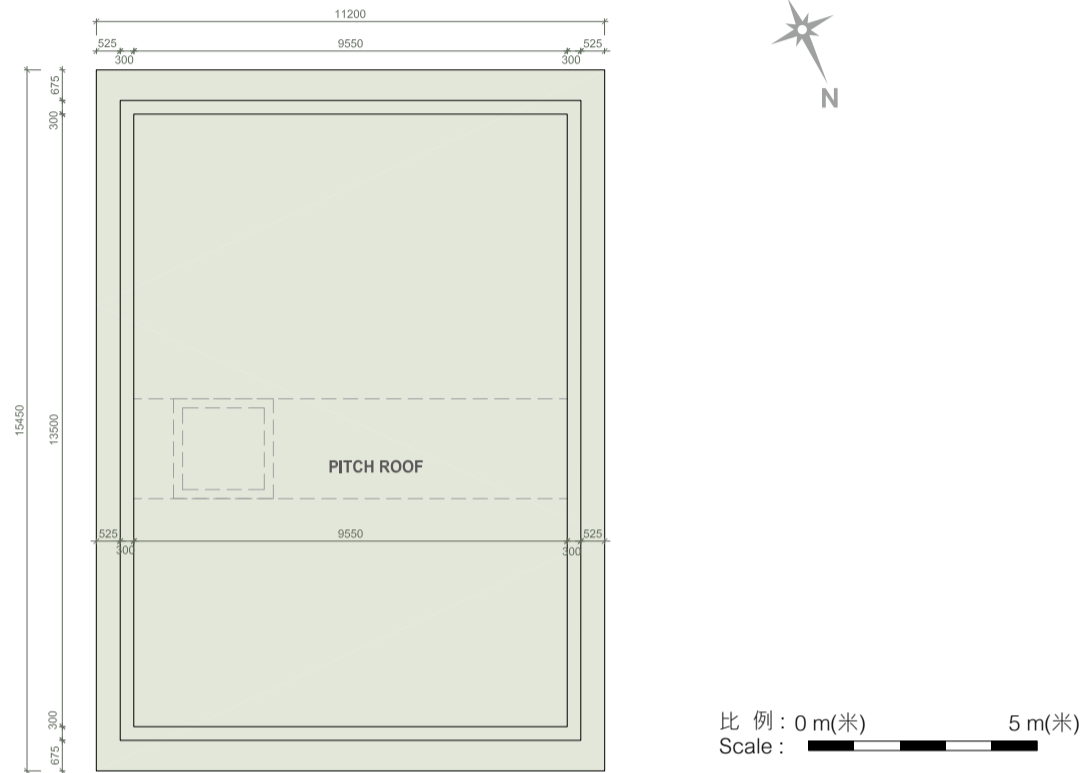

Roof Floor Plan 天台平面圖

Notes :

1. The internal areas of the residential properties on the upper floors will generally be slightly larger than those on the lower floors because of the reducing thickness of the structural walls on the upper floors.
2. The dimensions in the floor plans are all structural dimensions in millimetre.

備註：

1. 因住宅物業的較高樓層的結構牆的厚度遞減，較高樓層的內部面積，一般比較低樓層的內部面積稍大。
2. 樓面平面圖所列之尺寸為以毫米標示之建築結構尺寸。

77C Peak Road - 山頂道77C號	E&M/F 機電層	Lower Ground Floor 地下低層	Ground Floor 地下	First Floor 一樓	Second Floor 二樓	Roof 天台
The floor-to-floor height of the residential property (mm) 住宅物業的層與層之間的高度(毫米)	5855	4750	4450, 4500	3300, 3450, 3500, 3550	3500 - 4500	-
The thickness of the floor slabs (excluding plaster) of the residential property (mm) 住宅物業的樓板(不包括灰泥)的厚度(毫米)	200	150, 175	150, 175, 225	150, 225	100, 150, 175	-

77D Peak Road - 山頂道77D號

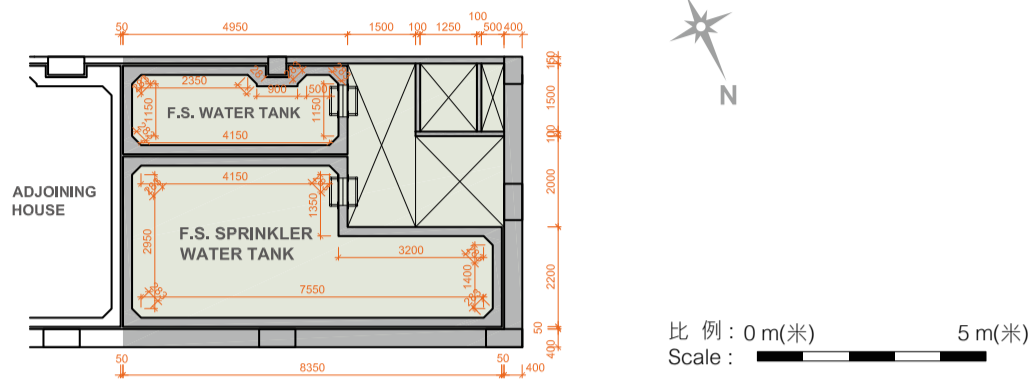

Electrical and Mechanical Floor (Above 1/F) 機電層平面圖 (高於一樓)

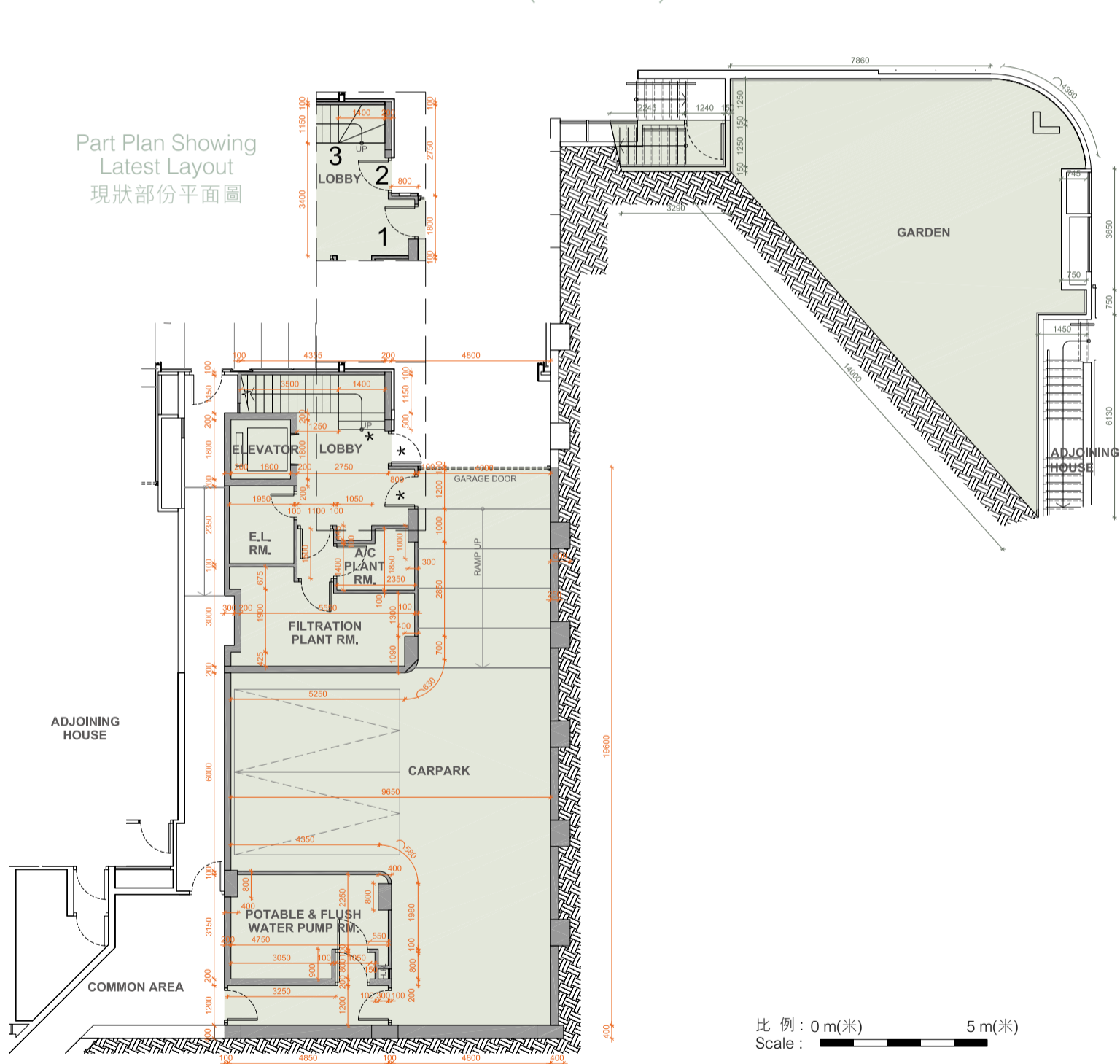

Lower Ground Floor Plan (Carpark) 地下低層平面圖 (停車場)

* This part of layout has been altered by way of minor works or exempted building works under the Buildings Ordinance after completion of the Development, the latest condition of which is shown on the relevant part plan.

The alteration works are as follows:

1. Carpark Lift Lobby door swing direction has been changed.
2. Lobby door swing direction has been changed.
3. Staircase has been modified.

* 此部份因在發展項目落成後進行小型工程或獲《建築物條例》豁免的工程而有所改動，現狀請參考有關部份平面圖。

該等改動如下：

1. 停車場升降機大堂擺門方向改動。
2. 大堂擺門方向改動。
3. 樓梯改動。

77D Peak Road - 山頂道77D號

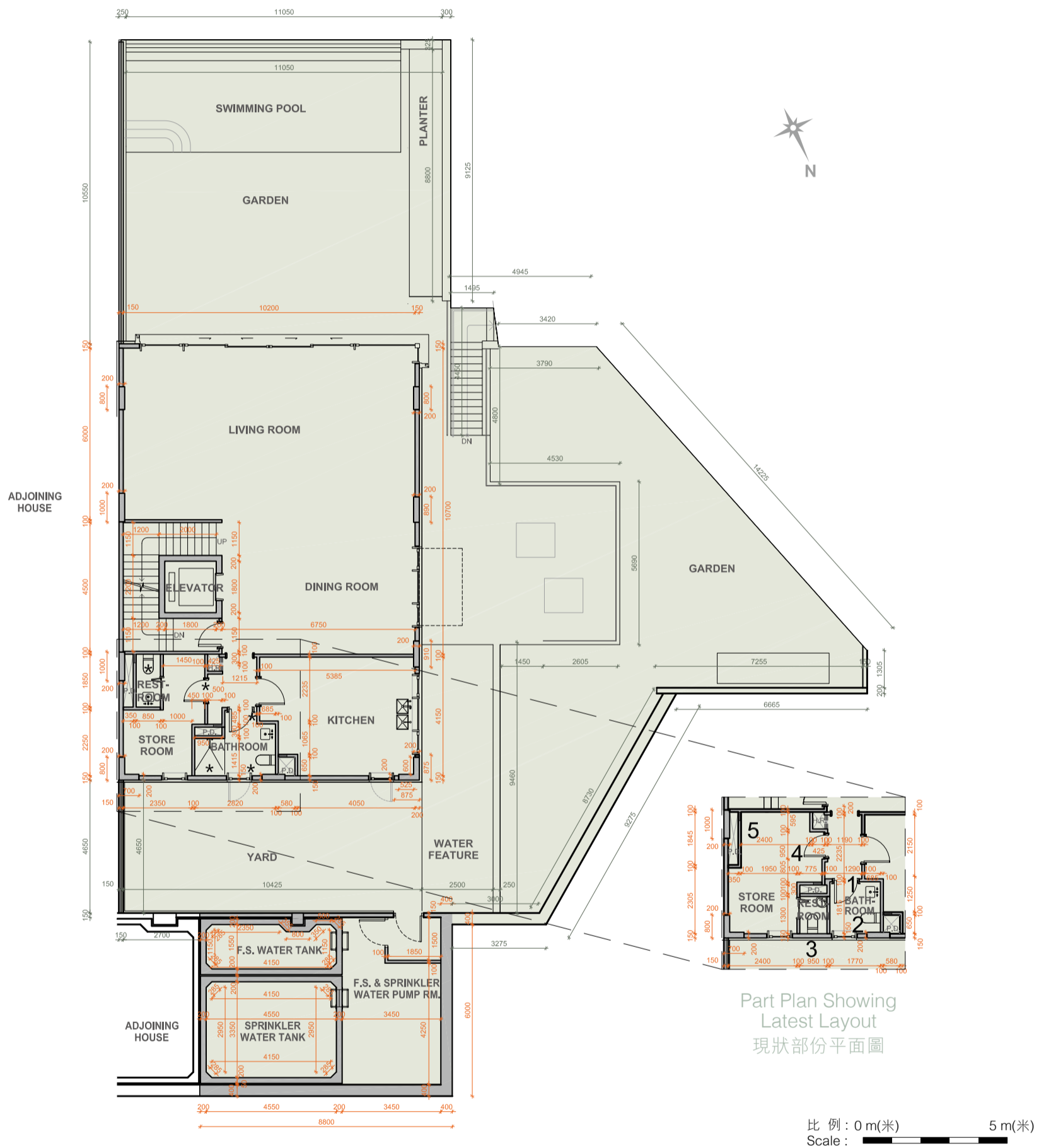

Ground Floor Plan 地下平面圖

* This part of layout has been altered by way of minor works or exempted building works under the Buildings Ordinance after completion of the Development, the latest condition of which is shown on the relevant part plan.

The alteration works are as follows:

1. Door at Bathroom has been shifted.
2. Bathroom layout has been amended.
3. Restroom has been added.
4. Door at Store Room has been shifted.
5. Restroom has been omitted.

* 此部份因在發展項目落成後進行小型工程或獲《建築物條例》豁免的工程而有所改動，現狀請參考有關部份平面圖。

該等改動如下：

1. 浴室門移位。
2. 浴室佈局改動。
3. 新增洗手間。
4. 儲物室門移位。
5. 洗手間移除。

77D Peak Road - 山頂道77D號

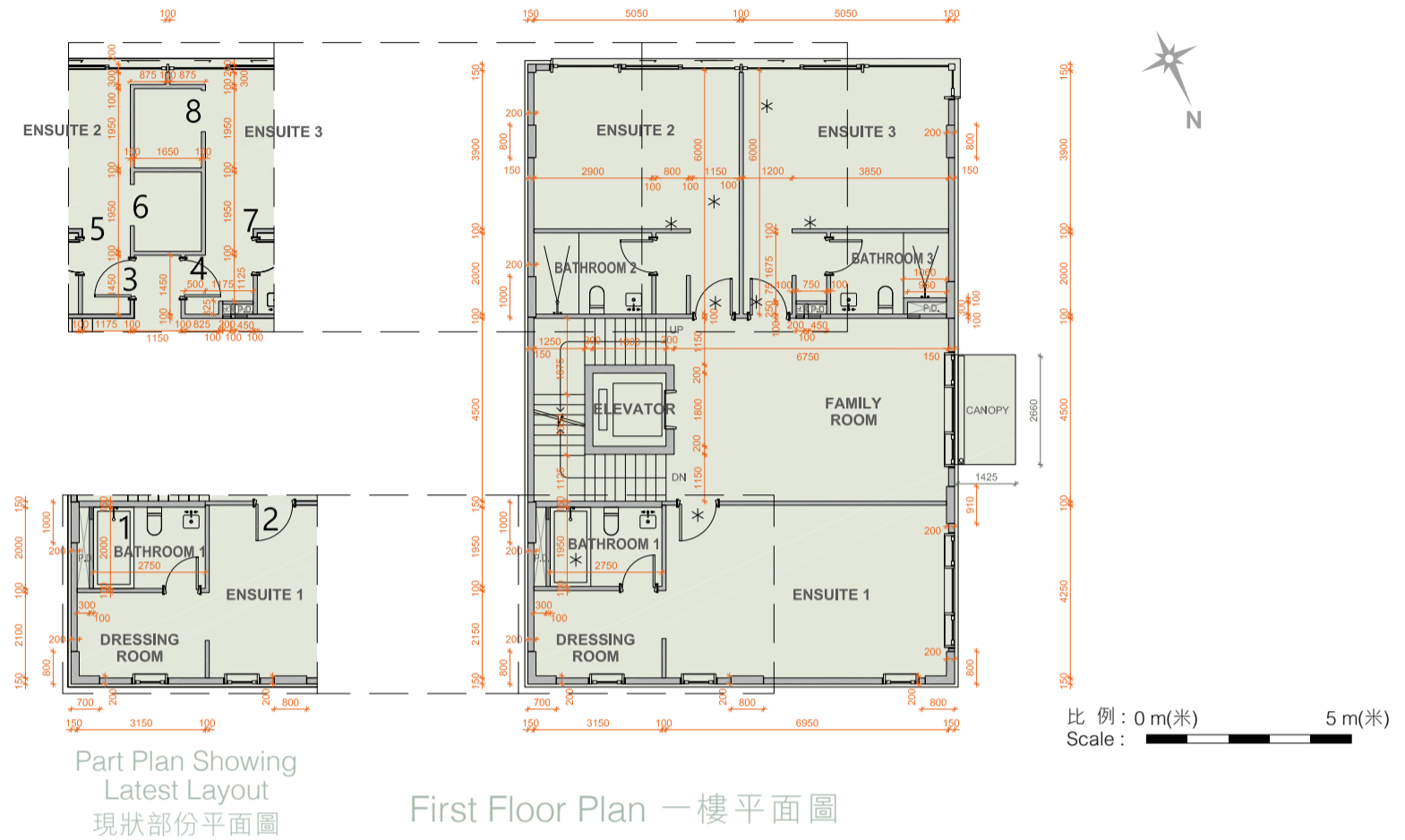

* This part of layout has been altered by way of minor works or exempted building works under the Buildings Ordinance after completion of the Development, the latest condition of which is shown on the relevant part plan.

The alteration works are as follows:

1. Non-structural wall between Bathroom 1 and Dressing Room has been shifted.
2. Door at Ensuite 1 has been shifted.
3. Door at Ensuite 2 has been relocated.
4. Door at Ensuite 3 has been relocated.
5. Non-structural wall at Ensuite 2 has been omitted.
6. Ensuite 2 layout has been amended.
7. Non-structural wall at Ensuite 3 has been omitted.
8. Ensuite 3 layout has been amended.

* 此部份因在發展項目落成後進行小型工程或獲《建築物條例》豁免的工程而有所改動，現狀請參考有關部份平面圖。

該等改動如下：

1. 浴室1與衣帽間之間的非結構牆移位。
2. 套房1門移位。
3. 套房2門移位。
4. 套房3門移位。
5. 套房2非結構牆移除。
6. 套房2佈局改動。
7. 套房3非結構牆移除。
8. 套房3佈局改動。

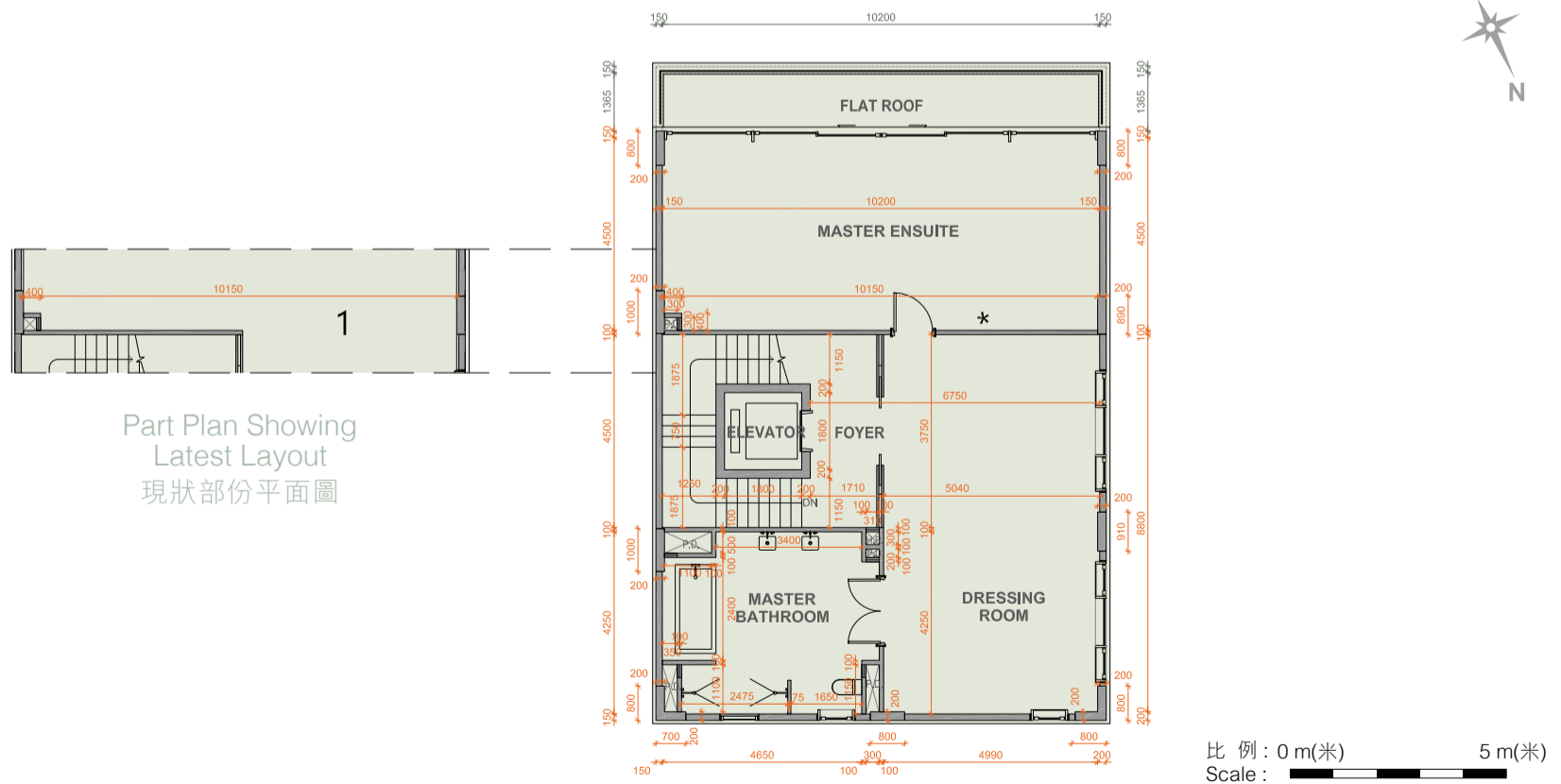

* This part of layout has been altered by way of minor works or exempted building works under the Buildings Ordinance after completion of the Development, the latest condition of which is shown on the relevant part plan.

The alteration works are as follows:

1. Non-structural wall between Master Ensuite and Dressing Room has been omitted.

* 此部份因在發展項目落成後進行小型工程或獲《建築物條例》豁免的工程而有所改動，現狀請參考有關部份平面圖。

該等改動如下：

1. 主人套房與衣帽間之間非結構牆移除。

77D Peak Road - 山頂道77D號

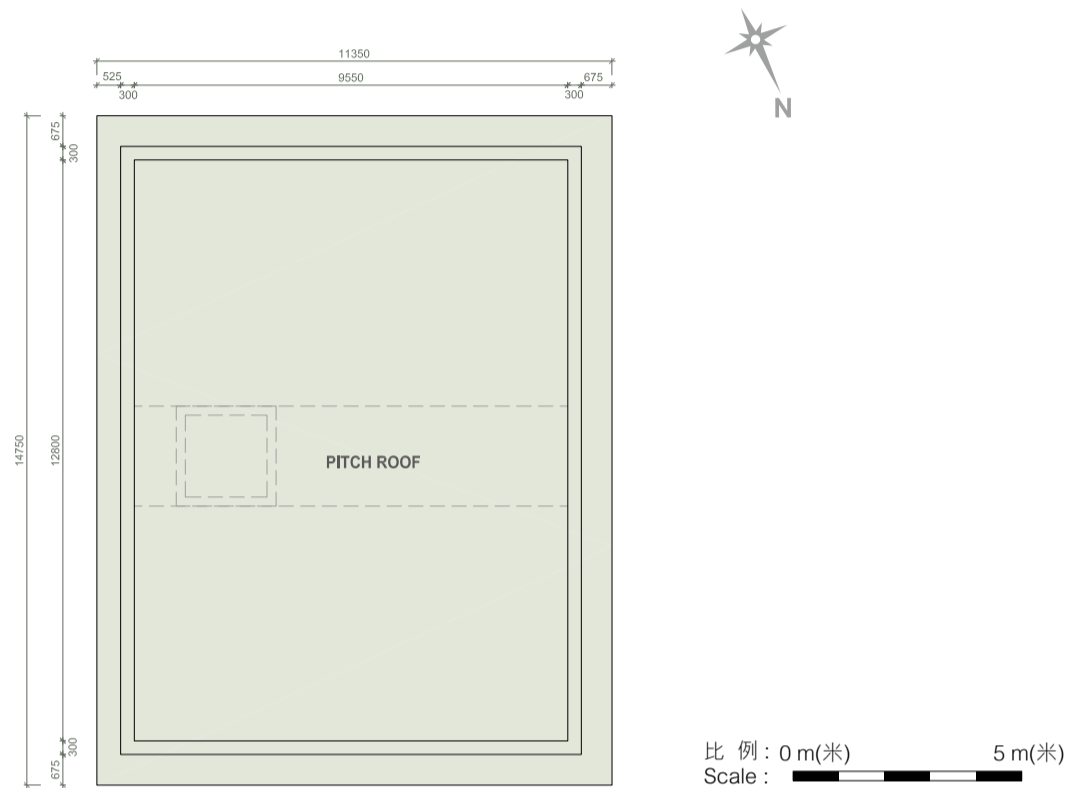

Roof Floor Plan 天台平面圖

Notes :

1. The internal areas of the residential properties on the upper floors will generally be slightly larger than those on the lower floors because of the reducing thickness of the structural walls on the upper floors.
2. The dimensions in the floor plans are all structural dimensions in millimetre.

備註：

1. 因住宅物業的較高樓層的結構牆的厚度遞減，較高樓層的內部面積，一般比較低樓層的內部面積稍大。
2. 樓面平面圖所列之尺寸為以毫米標示之建築結構尺寸。

77D Peak Road - 山頂道77D號	E&M/F 機電層	Lower Ground Floor 地下低層	Ground Floor 地下	First Floor 一樓	Second Floor 二樓	Roof 天台
The floor-to-floor height of the residential property (mm) 住宅物業的層與層之間的高度(毫米)	5855	5200	4450, 4500	3200, 3250, 3450, 3500, 3550	3500 - 4500	-
The thickness of the floor slabs (excluding plaster) of the residential property (mm) 住宅物業的樓板(不包括灰泥)的厚度(毫米)	200	150, 350	150, 175, 225	150, 225	100, 150, 175	-

77E Peak Road - 山頂道77E號

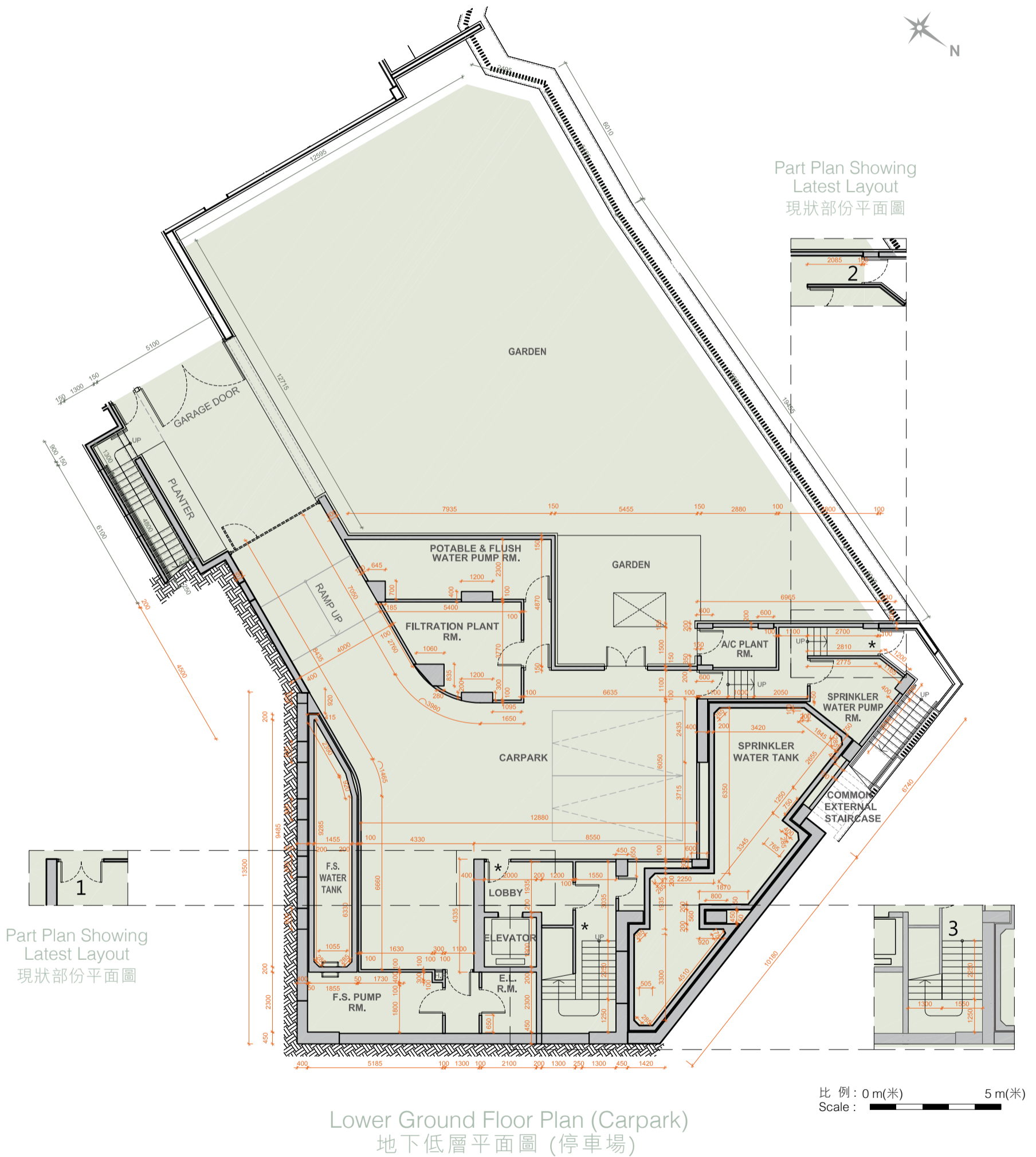

* This part of layout has been altered by way of minor works or exempted building works under the Buildings Ordinance after completion of the Development, the latest condition of which is shown on the relevant part plan.

The alteration works are as follows:

1. Single-leaf door at carpark Lift Lobby has been changed to double-leaf door.
2. Door at corridor to common external staircase has been shifted.
3. Staircase has been widened.

* 此部份因在發展項目落成後進行小型工程或獲《建築物條例》豁免的工程而有所改動，現狀請參考有關部份平面圖。

該等改動如下：

1. 停車場升降機大堂的單扇門更改為雙扇門。
2. 走廊門往公用室外樓梯移位。
3. 樓梯擴闊。

77E Peak Road - 山頂道77E號

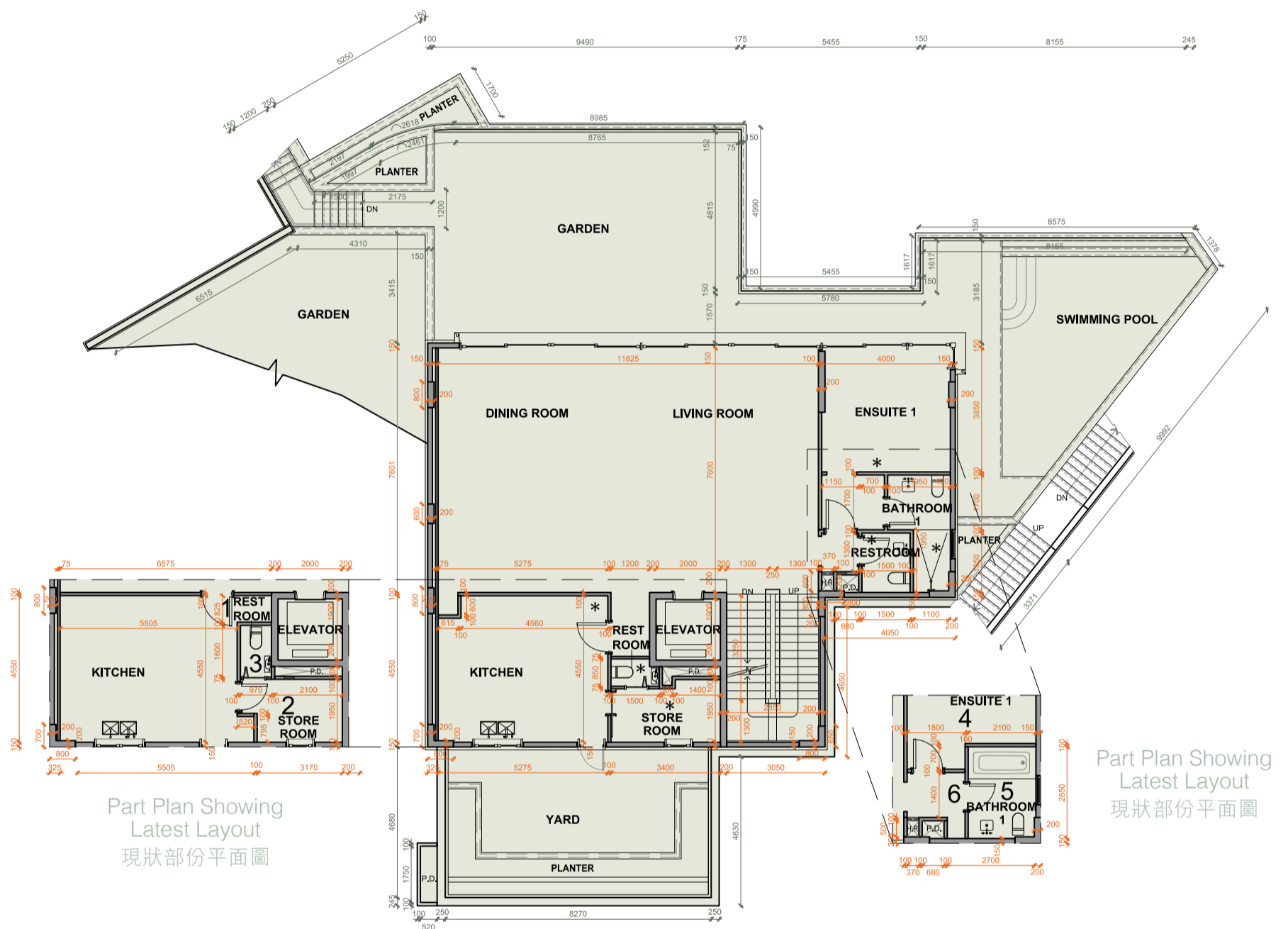

Part Plan Showing Latest Layout
現狀部份平面圖

Part Plan Showing Latest Layout
現狀部份平面圖

比例：0 m(米) 5 m(米)
Scale: 0 m(米) 5 m(米)

Ground Floor Plan 地下平面圖

* This part of layout has been altered by way of minor works or exempted building works under the Buildings Ordinance after completion of the Development, the latest condition of which is shown on the relevant part plan.

The alteration works are as follows:

1. Kitchen layout and door have been amended.
2. Store Room layout has been amended.
3. Restroom layout and positions of sanitary fittings have been amended.
4. Ensuite 1 layout has been amended.
5. Bathroom 1 layout and positions of sanitary fittings have been amended.
6. Restroom has been omitted.

* 此部份因在發展項目落成後進行小型工程或獲《建築物條例》豁免的工程而有所改動，現狀請參考有關部份平面圖。

該等改動如下：

1. 廚房佈局和門改動。
2. 儲物室佈局改動。
3. 洗手間佈局和衛浴潔具位置改動。
4. 套房1佈局改動。
5. 浴室1佈局和衛浴潔具位置改動。
6. 洗手間移除。

77E Peak Road - 山頂道77E號

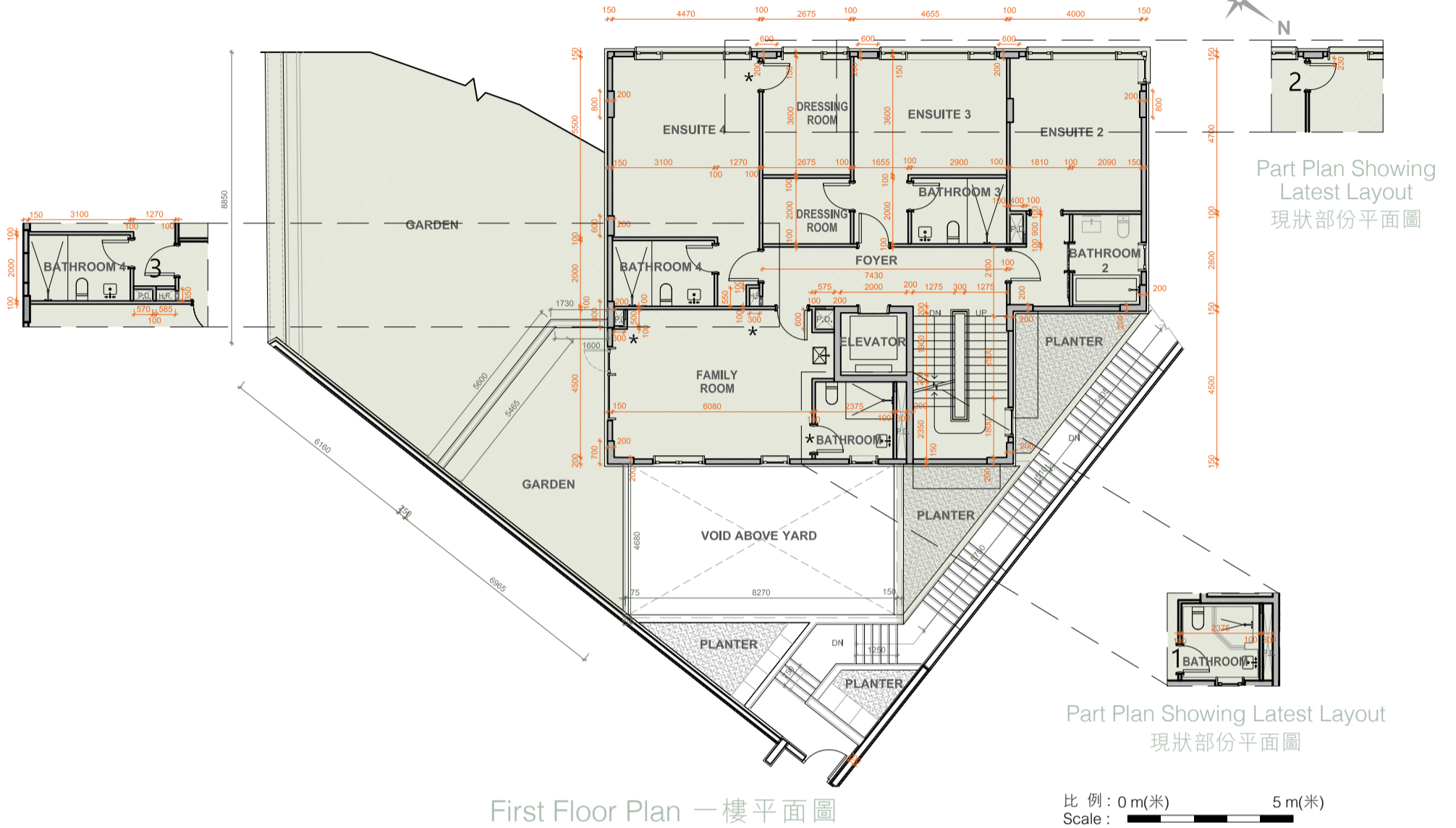

First Floor Plan 一樓平面圖

* This part of layout has been altered by way of minor works or exempted building works under the Buildings Ordinance after completion of the Development, the latest condition of which is shown on the relevant part plan.

The alteration works are as follows:

1. Door at Bathroom has been shifted.
2. Door of Dressing Room at Ensuite 4 has been shifted.
3. Pipe duct and fire hose reel have been relocated.

* 此部份因在發展項目落成後進行小型工程或獲《建築物條例》豁免的工程而有所改動，現狀請參考有關部份平面圖。

該等改動如下：

1. 浴室門移位。
2. 套房4衣帽間的門移位。
3. 管槽及消防喉轆移位。

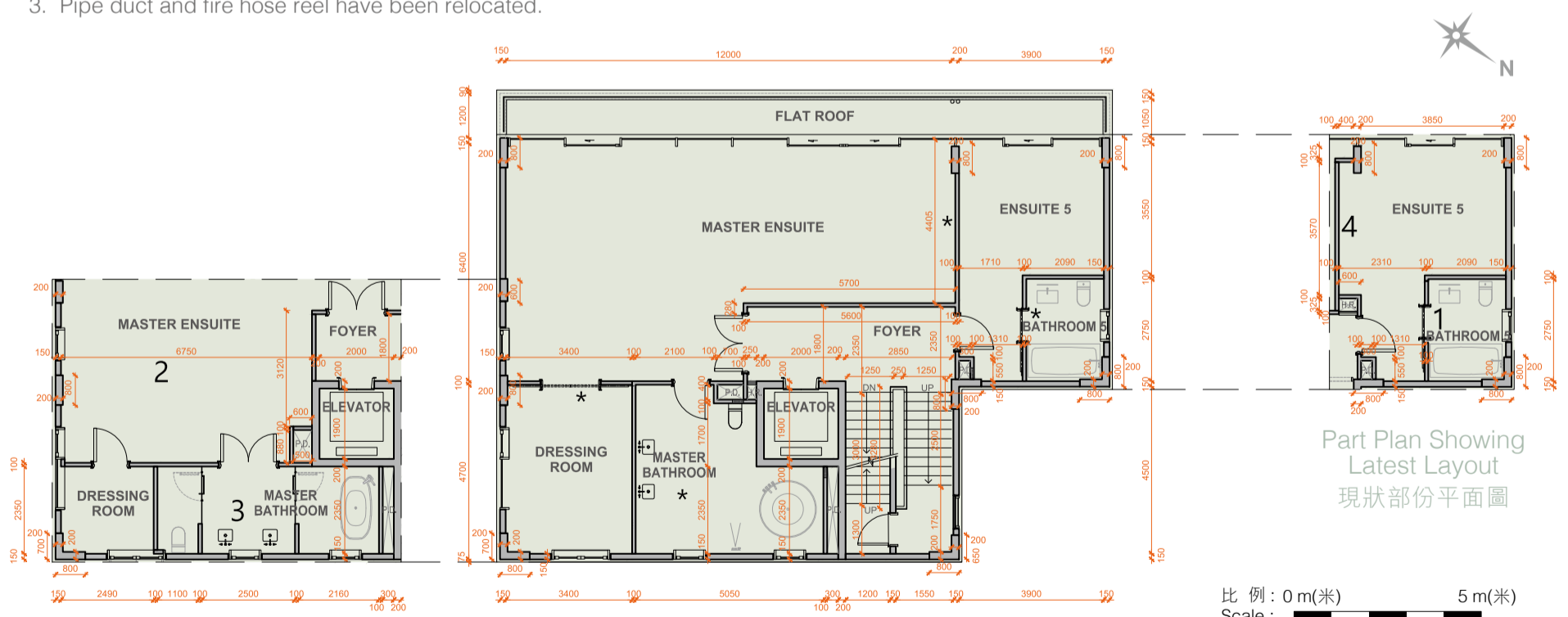

Second Floor Plan 二樓平面圖

* This part of layout has been altered by way of minor works or exempted building works under the Buildings Ordinance after completion of the Development, the latest condition of which is shown on the relevant part plan.

The alteration works are as follows:

1. Door at Bathroom 5 has been shifted.
2. Foyer and Master Ensuite layout have been amended.
3. Master Bathroom and Dressing Room layout have been amended.
4. Ensuite 5 layout has been amended.

* 此部份因在發展項目落成後進行小型工程或獲《建築物條例》豁免的工程而有所改動，現狀請參考有關部份平面圖。

該等改動如下：

1. 浴室5門移位。
2. 前廳及主人套房佈局改動。
3. 主人浴室及衣帽間佈局改動。
4. 套房5佈局改動。

77E Peak Road - 山頂道77E號

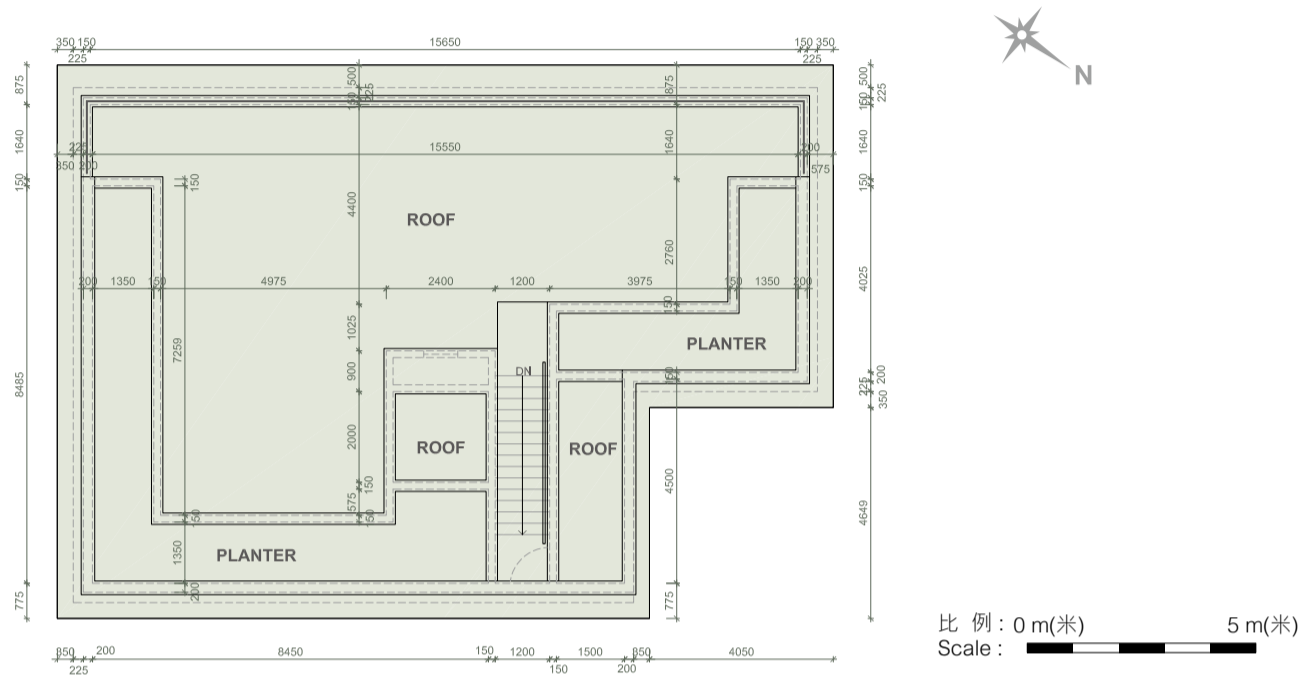

Roof Floor Plan 天台平面圖

Notes :

1. The internal areas of the residential properties on the upper floors will generally be slightly larger than those on the lower floors because of the reducing thickness of the structural walls on the upper floors.
2. The dimensions in the floor plans are all structural dimensions in millimetre.

備註 :

1. 因住宅物業的較高樓層的結構牆的厚度遞減，較高樓層的內部面積，一般比較低樓層的內部面積稍大。
2. 樓面平面圖所列之尺寸為以毫米標示之建築結構尺寸。

77E PEAK ROAD 山頂道77E號	Lower Ground Floor 地下低層	Ground Floor 地下	First Floor 一樓	Second Floor 二樓	Roof 天台
The floor-to-floor height of the residential property (mm) 住宅物業的層與層之間的高度(毫米)	4000	4200, 4450, 4500, 4750, 4900, 4950	3200, 3225, 3275, 3450, 3500, 3550, 3800	3500, 3550, 3775	-
The thickness of the floor slabs (excluding plaster) of the residential property (mm) 住宅物業的樓板(不包括灰泥)的厚度(毫米)	150, 200, 250	150, 175, 275	150, 175, 275	150, 175, 250	-

77F Peak Road - 山頂道77F號

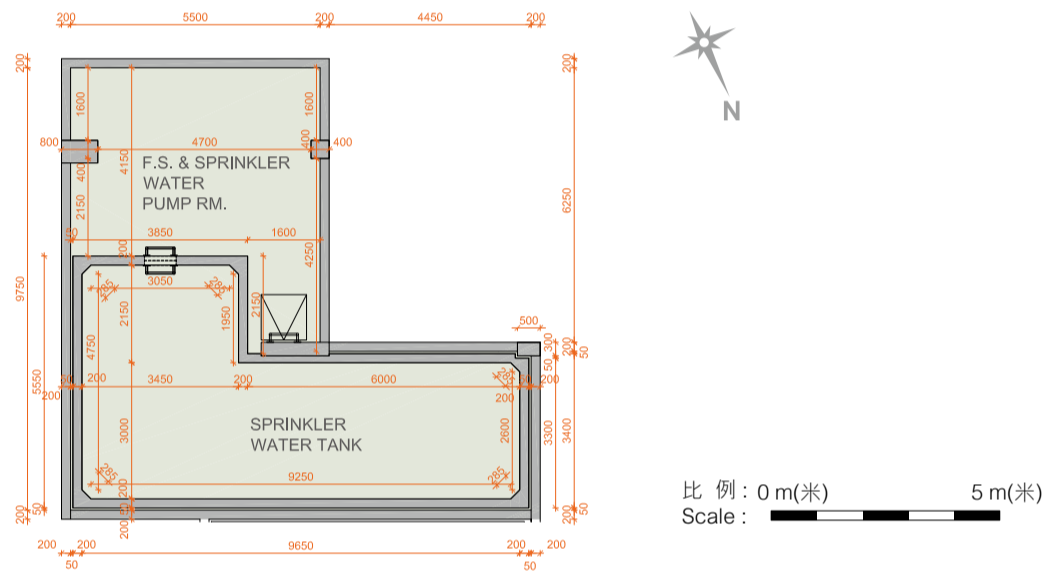

Electrical and Mechanical Floor Plan
(Below Lower Ground)
機電層平面圖
(低於地下低層)

77F Peak Road - 山頂道77F號

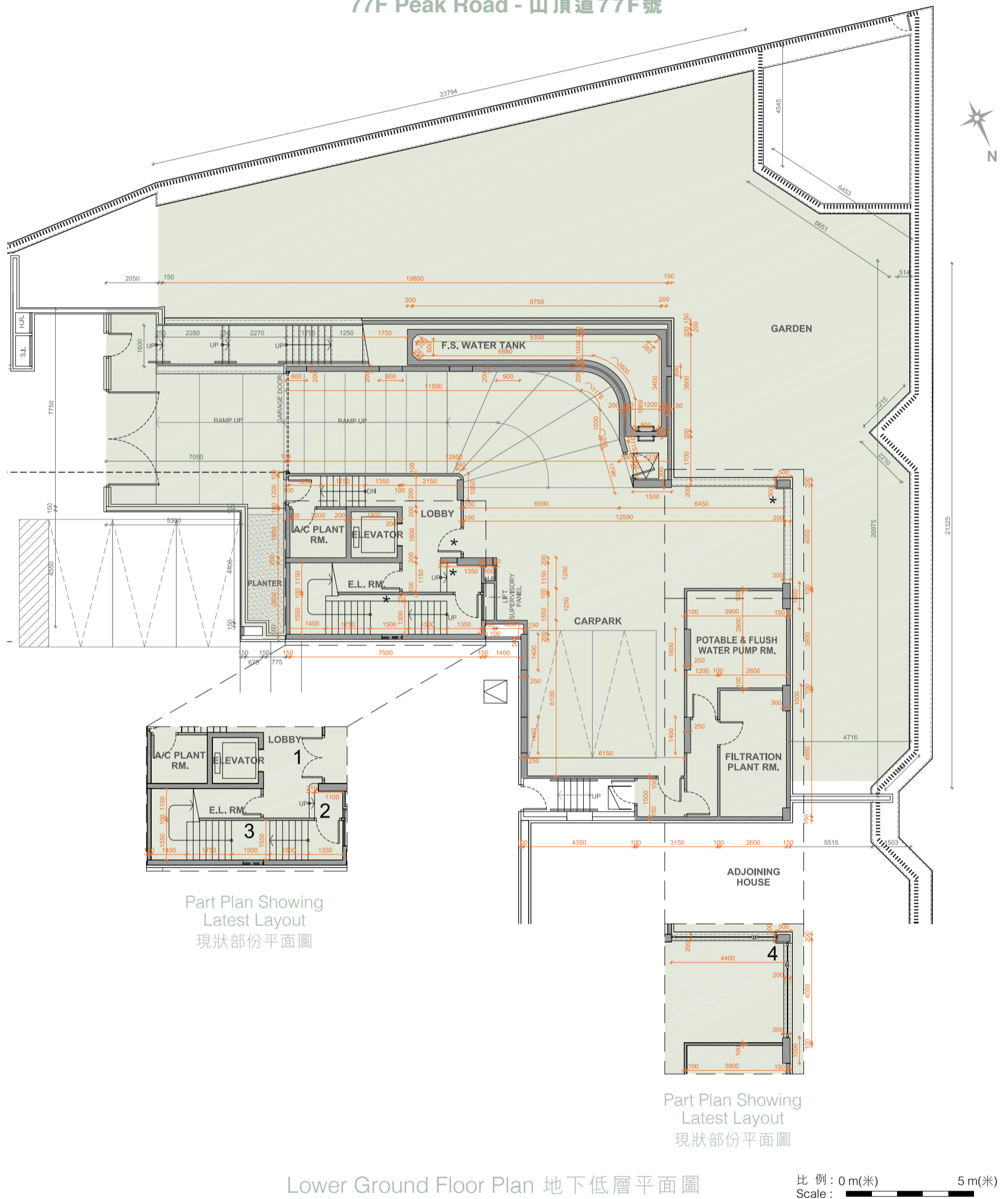

Lower Ground Floor Plan 地下低層平面圖

比例：0 m(米) 5 m(米)
Scale: 0 5

* This part of layout has been altered by way of minor works or exempted building works under the Buildings Ordinance after completion of the Development, the latest condition of which is shown on the relevant part plan.

The alteration works are as follows:

1. Single-leaf door at carpark Lift Lobby has been changed to double-leaf door.
2. Non-structural block wall has been removed. Staircase has been modified.
3. Gap between non-structural block wall and staircase has been filled.
4. Additional windows have been installed.

* 此部份因在發展項目落成後進行小型工程或獲《建築物條例》豁免的工程而有所改動，現狀請參考有關部份平面圖。

該等改動如下：

1. 停車場升降機大堂的單扇門更改為雙扇門。
2. 非結構牆移除。樓梯改動。
3. 非結構牆與樓梯之間的空隙回填。
4. 額外窗戶安裝。

77F Peak Road - 山頂道77F號

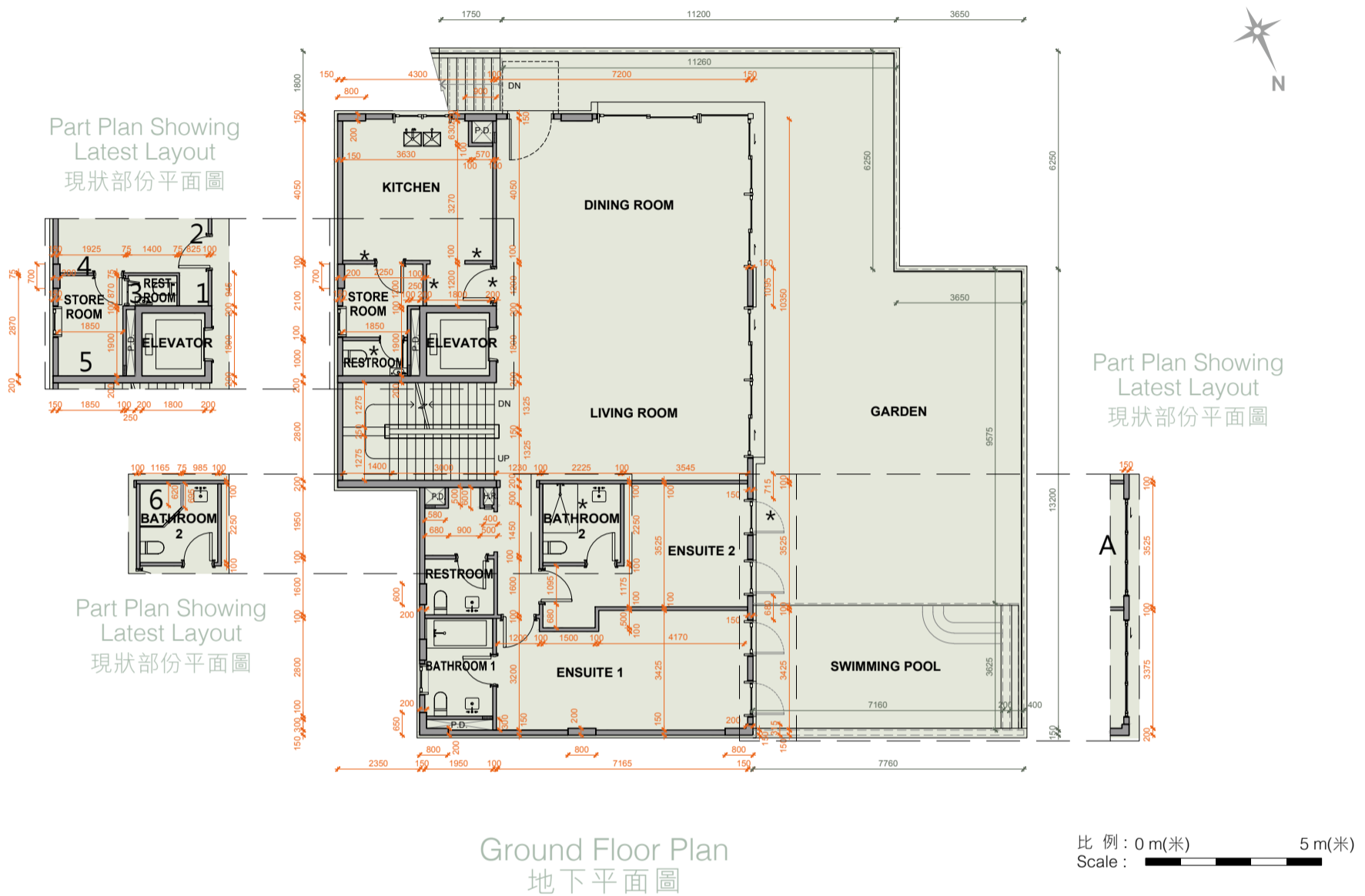

Ground Floor Plan
地下平面圖

比例：0 m(米) 5 m(米)
Scale : 0m 5m

* This part of layout has been altered by way of Addition & Alteration Works approved by Building Department after completion of the Development, the latest condition of which is shown on the relevant part plan.

The alteration works are as follows:

- A. Alteration of folding glass door.

* This part of layout has been altered by way of minor works or exempted building works under the Buildings Ordinance after completion of the Development, the latest condition of which is shown on the relevant part plan.

The alteration works are as follows:

1. Door at Kitchen has been shifted.
2. Non-structural wall at Kitchen has been omitted.
3. Restroom has been added.
4. Non-structural wall between Kitchen and Store Room has been shifted.
5. Restroom has been omitted.
6. Non-structural wall has been added to Bathroom 2.

* 此部份因在發展項目落成後進行改建及加建工程獲批准的工程而有所改動，現狀請參考有關部份平面圖。

該等改動如下：

- A. 改建為玻璃摺門。

* 此部份因在發展項目落成後進行小型工程或獲《建築物條例》豁免的工程而有所改動，現狀請參考有關部份平面圖。

該等改動如下：

1. 廚房門移位。
2. 廚房非結構牆移除。
3. 新增洗手間。
4. 廚房與儲物室之間的非結構牆移位。
5. 洗手間移除。
6. 浴室2新增非結構牆。

77F Peak Road - 山頂道77F號

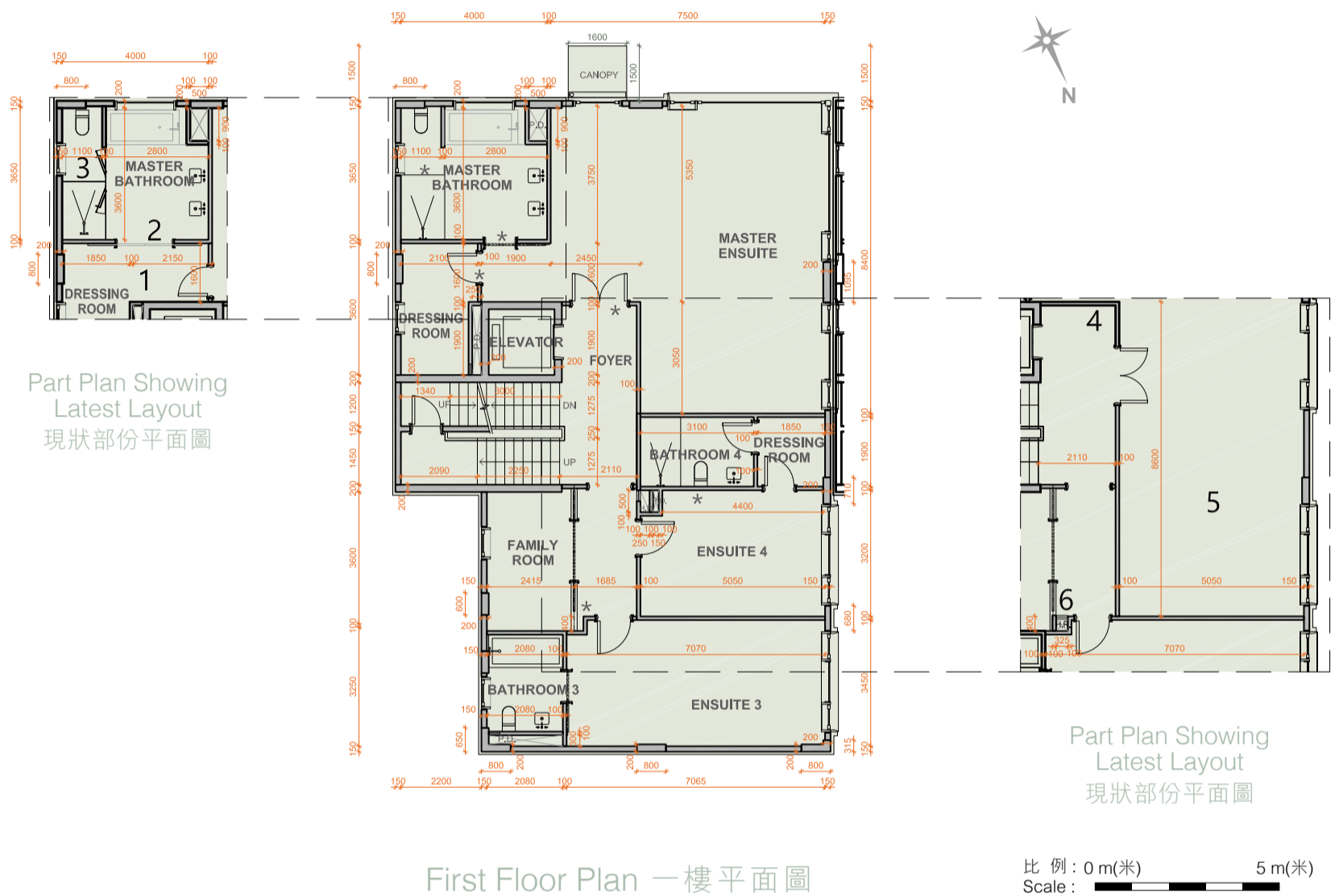

First Floor Plan 一樓平面圖

* This part of layout has been altered by way of minor works or exempted building works under the Buildings Ordinance after completion of the Development, the latest condition of which is shown on the relevant part plan.

The alteration works are as follows:

1. Door at Dressing Room has been shifted.
2. Single sliding door at Master Bathroom has been shifted.
3. Glass wall/ glass doors have been added to Master Bathroom.
4. Door at Master Ensuite has been relocated.
5. Pipe duct, Ensuite 4, Bathroom 4 and Dressing Room have been omitted.
6. Fire hose reel has been relocated.

* 此部份因在發展項目落成後進行小型工程或獲《建築物條例》豁免的工程而有所改動，現狀請參考有關部份平面圖。

該等改動如下：

1. 衣帽間門移位。
2. 主人浴室單滑門移位。
3. 主人浴室新增玻璃牆/玻璃門。
4. 主人套房門移位。
5. 管槽、套房4、浴室4和衣帽間移除。
6. 消防喉轆移位。

77F Peak Road - 山頂道77F號

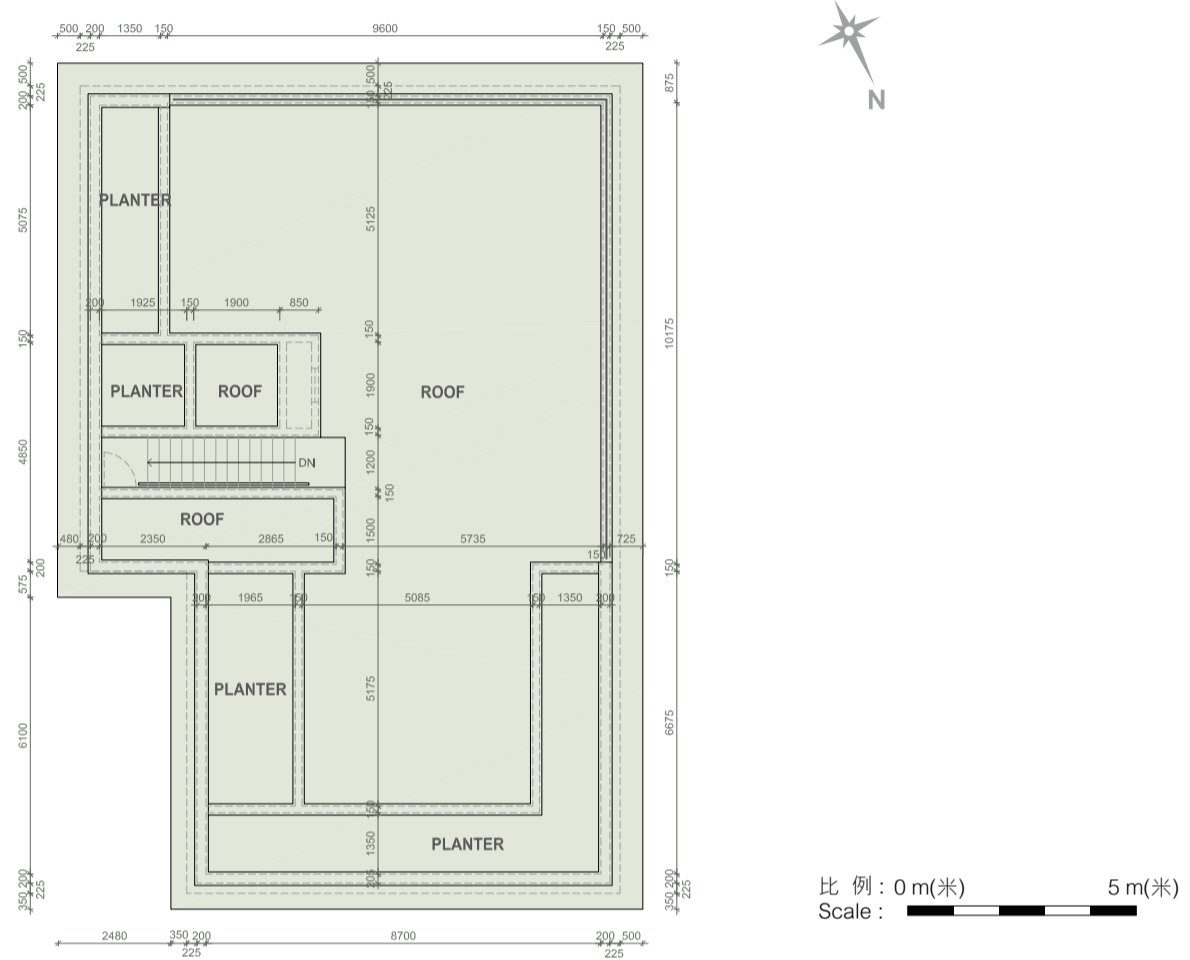

Roof Floor Plan 天台平面圖

Notes :

1. The internal areas of the residential properties on the upper floors will generally be slightly larger than those on the lower floors because of the reducing thickness of the structural walls on the upper floors.
2. The dimensions in the floor plans are all structural dimensions in millimetre.

備註：

1. 因住宅物業的較高樓層的結構牆的厚度遞減，較高樓層的內部面積，一般比較低樓層的內部面積稍大。
2. 樓面平面圖所列之尺寸為以毫米標示之建築結構尺寸。

77F Peak Road - 山頂道77F號	E&M/F 機電層	Lower Ground Floor 地下低層	Ground Floor 地下	First Floor 一樓	Roof 天台
The floor-to-floor height of the residential property (mm) 住宅物業的層與層之間的高度(毫米)	4000	4750	4225, 4450, 4500, 4550, 4800	3500, 3550, 3775	-
The thickness of the floor slabs (excluding plaster) of the residential property (mm) 住宅物業的樓板(不包括灰泥)的厚度(毫米)	150, 200, 250	150, 200, 225, 250, 350	150, 175, 275	150, 175, 250	-

Description of Residential Property 住宅物業的描述	Saleable Area (Including balcony, utility platform and verandah, if any) sq.metre (sq.ft.)	Area of other specified items (Not included in the Saleable Area) sq.metre (sq.ft.) 其他指明項目的面積(不計算入實用面積) 平方米(平方呎)									
		Air-conditioning Plant Room 空調機房	Bay Window 窗台	Cockloft 閣樓	Flat Roof 平台	Garden 花園	Parking Space 停車位	Roof 天台	Stairhood 梯屋	Terrace 前庭	Yard 庭院
79 Peak Road 山頂道 79號	756.137 (8139) (Balcony 露台: - (-)) (Utility Platform 工作平台: - (-)) (Verandah 陽台: -(-))	5.825 (63)	-	-	-	183.364 (1974)	223.299 (2404)	260.435 (2803)	4.662 (50)	-	225.257 (2425)
79A Peak Road 山頂道79A號	733.580 (7896) (Balcony 露台: - (-)) (Utility Platform 工作平台: - (-)) (Verandah 陽台: -(-))	5.654 (61)	-	-	14.753 (159)	180.081 (1938)	150.336 (1618)	153.962 (1657)	8.597 (93)	-	102.773 (1106)
77A Peak Road 山頂道77A號	686.389 (7388) (Balcony 露台: - (-)) (Utility Platform 工作平台: - (-)) (Verandah 陽台: -(-))	1.760 (19)	-	-	13.335 (144)	787.463 (8476)	101.327 (1091)	-	-	-	73.587 (792)
77B Peak Road 山頂道77B號	620.239 (6676) (Balcony 露台: - (-)) (Utility Platform 工作平台: - (-)) (Verandah 陽台: -(-))	-	-	-	13.770 (148)	273.739 (2947)	109.708 (1181)	-	-	-	-
77C Peak Road 山頂道77C號	581.300 (6257) (Balcony 露台: 6.000(65)) (Utility Platform 工作平台: - (-)) (Verandah 陽台: -(-))	3.410 (37)	-	-	-	125.318 (1349)	86.689 (933)	-	-	-	85.763 (923)
77D Peak Road 山頂道77D號	582.099 (6266) (Balcony 露台: - (-)) (Utility Platform 工作平台: - (-)) (Verandah 陽台: -(-))	3.750 (40)	-	-	13.770 (148)	365.300 (3932)	105.398 (1135)	-	-	-	74.637 (803)
77E Peak Road 山頂道77E號	699.295 (7527) (Balcony 露台: - (-)) (Utility Platform 工作平台: - (-)) (Verandah 陽台: -(-))	4.366 (47)	-	-	16.905 (182)	605.292 (6515)	147.438 (1587)	132.082 (1422)	-	-	55.316 (595)
77F Peak Road 山頂道77F號	563.121 (6061) (Balcony 露台: - (-)) (Utility Platform 工作平台: - (-)) (Verandah 陽台: -(-))	4.180 (45)	-	-	-	473.341 (5095)	150.906 (1624)	164.656 (1772)	-	-	-

- The Top Roof of stairhood is not provided with any access and is not enclosed by parapet, railing or balustrade.
- The saleable area is calculated in accordance with Section 8 of the Residential Properties (First-hand Sales) Ordinance. Saleable Area includes areas of (if any) balcony(ies), plant room(s) (other than air-conditioning plant room(s)) and filtration plant room(s).
- The floor areas of balcony, utility platform and verandah, if any, are calculated in accordance with Section 8 of the Residential Properties (First-hand Sales) Ordinance.
- The areas of other specified items (not included in the saleable area) are calculated in accordance with Part 2 of Schedule 2 to the Residential Properties (First-hand Sales) Ordinance.

Notes:

The areas in square metres have been converted to square feet based on a conversion rate of 1 square metre = 10.764 square feet and rounded off to the nearest integer. The area of the Parking Space specified in the section "Area of Residential Properties in the Development" in this sales brochure includes the area of the entire carport of the House (as indicated in the section "Floor Plans of Parking Spaces in the Development" in this sales brochure). For the area inside the carport which is designated under the land grant for the parking purpose, please refer to the area of parking space under the section "Floor Plans of Parking Spaces in the Development" in this sales brochure.

- 梯屋頂層天台並無設有任何出入口或上落途徑，且無矮牆、護欄或扶欄圍封。
- 實用面積是按《一手住宅物業銷售條例》第8條計算得出的。實用面積包括(如有)露台、機房(空調機房除外)及濾水器機房面積。
- 露台、工作平台及陽台(如有)之樓面面積是按《一手住宅物業銷售條例》第8條計算得出的。
- 其他指明項目的面積(不計算入實用面積)是按《一手住宅物業銷售條例》附表2第2部計算得出的。

備註：

以平方呎列出的面積以1平方米=10.764平方呎換算，並以四捨五入至整數。本售樓說明書「發展項目中的住宅物業的面積」一節所列停車位之面積包括相關洋房之車房(車房於本售樓說明書「發展項目中的停車位的樓面平面圖」一節有所標示)之全部面積。批地文件指明車房內用作停放車輛的地方之面積，請參考本售樓說明書「發展項目中的停車位的樓面平面圖」一節之車位面積。

77A to 77F Peak Road 山頂道77A至77F號
Lower Ground Floor Plan 地下低層平面圖



79A Peak Road 山頂道79A號
Lower Ground Floor Plan 地下低層平面圖



79 Peak Road 山頂道79號
Ground Floor Plan 地下平面圖



Numbers, dimensions and areas of parking spaces 停車位數目、尺寸及面積

Category of Parking Space 停車位類別	House Number 屋號	Location 位置	Number 數目	Dimensions of each Parking Space (L x W) (m) 每個停車位之尺寸 (長 x 闊) (米)	Area of each Parking Space (sq.m.) 每個停車位之面積 (平方米)
Parking Space 停車位	79 Peak Road 山頂道79號	Ground Floor 地下	2	5.0 x 2.5	12.5
	79A Peak Road 山頂道79A號	Lower Ground Floor 地下低層	2	5.0 x 2.5	12.5
	77A Peak Road 山頂道77A號	Lower Ground Floor 地下低層	2	5.0 x 2.5	12.5
	77B Peak Road 山頂道77B號		2	5.0 x 2.5	12.5
	77C Peak Road 山頂道77C號		2	5.0 x 2.5	12.5
	77D Peak Road 山頂道77D號		2	5.0 x 2.5	12.5
	77E Peak Road 山頂道77E號		2	5.0 x 2.5	12.5
	77F Peak Road 山頂道77F號		2	5.0 x 2.5	12.5
Visitors' Carparking Space 訪客停車位	-		Lower Ground Floor 地下低層	4	5.0 x 2.5
Visitors' (Accessible) Carparking Space 訪客(暢通易達)停車位	-	Lower Ground Floor 地下低層	1	5.0 x 3.5	17.5

- (a) A preliminary deposit of 5% of the purchase price is payable on the signing of the preliminary agreement for sale and purchase.
 - (b) The preliminary deposit paid by the purchaser on the signing of the preliminary agreement will be held by a firm of solicitors acting for the owner, as stakeholders.
 - (c) If the purchaser fails to execute the agreement for sale and purchase within 5 working days after the date on which the purchaser enters into that preliminary agreement—
 - (i) that preliminary agreement is terminated;
 - (ii) the preliminary deposit is forfeited; and
 - (iii) the owner does not have any further claim against the purchaser for the failure.
- (a) 在簽署臨時買賣合約時須支付款額為售價之5%的臨時訂金。
 - (b) 買方在簽署該臨時合約時支付的臨時訂金，會由代表擁有人行事的律師事務所以保證金保存人的身分持有。
 - (c) 如買方沒有於訂立該臨時合約的日期之後5個工作日內簽立買賣合約——
 - (i) 該臨時合約即告終止；
 - (ii) 有關的臨時訂金即予沒收；及
 - (iii) 擁有人不得就買方沒有簽立買賣合約而針對買方提出進一步申索。

COMMON PARTS OF THE DEVELOPMENT

1. The Deed of Mutual Covenant and Management Agreement of the Development ("the DMC") provides for the following Common Areas and Common Facilities:-

- (i) "Estate Common Areas" mean such of the entrance lobby, accessory areas, circulation passages, driveways, ramps, entrances, exits, switch rooms, meter rooms, passageways, staircases, planters, Recreational Areas and Facilities, Visitors' Carparking Spaces, telecommunication and broadcasting equipment room, transformer room, High-voltage switch gear compartment, Low-voltage switch room, passageways, emergency vehicular access, staircases and external walls and fences of the whole Estate (other than those of the Houses), refuse storage and material recovery chamber, street fire hydrants pump room and water tanks, plant rooms serving the communal area and recreational facilities, maintenance path serving the road-widening structure, areas for the installation or use of aerial broadcast distribution or telecommunications network facilities and other areas and spaces containing the Estate Common Facilities and other areas and spaces in any part or parts of the Estate which are for the common use and benefit of the Owners of the Estate, PROVIDED THAT, where appropriate, if (a) any parts of the Estate covered by paragraph (a) of the definition of "common parts" set out in section 2 of the Building Management Ordinance and/or (b) any parts specified in the Schedule 1 to the Building Management Ordinance and included under paragraph (b) of the definition of "common parts" set out in section 2 of the Building Management Ordinance, shall also be covered by the provisions hereinbefore provided, such parts shall be deemed to have been included as, and shall form part of, the Estate Common Areas are shown for the purpose of identification on the plan(s) annexed to the DMC, the accuracy of such plan(s) has been certified by or on behalf of the Authorised Person, and thereon coloured Green, EXCLUDING those areas designated as being part of the Houses.
- (ii) "Estate Common Facilities" include all equipment, facilities and systems designated as being for the use, benefit or service of the Estate Common Areas and without limiting the generality of the foregoing, include:-
 - (a) Such of the sewers, drains, water courses, pipes, gutters, wires and cables and other service facilities whether ducted or otherwise which are or at any time may be in, under or over or passing through the Estate through which water, sewage, gas, electricity and any other services are supplied to the Estate or any part or parts thereof;
 - (b) Fire fighting installation and equipment;
 - (c) Lamp posts, traffic lights and lighting within the Estate;
 - (d) Lightning conductor of the Estate;
 - (e) Lift installation and equipment; and
 - (f) Other facilities and systems for the use and benefit of the Estate and not for the use and benefit of any particular Owner.
- (iii) "Public Common Areas and Facilities" means the Green Area, the Green Stippled Black Area (of which until possession of the same is redelivered to the Government) and those parts of the Estate Common Areas and Estate Common Facilities which are open for public use pursuant to the terms and conditions of the Land Grant or the DMC.

(iv) "Recreational Areas and Facilities" means those recreational areas and facilities in the Estate Common Area including (but not limited to) swimming pool, gymnasium and other areas and facilities for the common use of the residents of the Houses as well as their bona fide visitors for recreational purposes and all ancillary equipment, facilities and structures serving such areas.

(v) "Visitors' Carparking Space" means a carparking space designated as being for the parking of visitors' motor vehicles provided pursuant to Clause (29)(a)(iv) of the Fourth Schedule to the 1st Modification Letter.

2. The Estate Common Areas and the Estate Common Facilities are common areas and facilities for the benefit of all Owners and may be used by each Owner.
3. No Owner shall have the right to convert the Estate Common Areas and/or the Estate Common Facilities or any part thereof to his own use or for his own benefit unless approved by the Owners' Committee.
4. No Owner shall have the right to convert or designate any of his own areas as the Estate Common Areas and/or the Estate Common Facilities unless the approval by a resolution of Owners at an Owners' meeting. No Owner will have the right to re-convert or re-designate the Estate Common Areas to his or its own use or benefit.
5. No Owner shall use, cut, injure, damage, alter or interfere with any part or parts of the Estate Common Areas or the Estate Common Facilities nor any equipment or apparatus on, in or upon the Land not being equipment or apparatus for the exclusive use, enjoyment and benefit of any such Owner.
6. No Owner shall alter, repair, connect to or in any other way interfere with or affect the Estate Common Areas or the Estate Common Facilities without the previous written consent of the Manager.
7. No Owner shall use any part of the Estate Common Areas for the purposes of drying or hanging laundry, or placing or storing any dustbins, garbage cans, furniture, machinery, goods or chattels or other things thereon or therein other than in the spaces specifically provided for such purpose.
8. No part of the Estate Common Areas shall be obstructed or incumbered nor shall any refuse or other matter or things be placed or left thereon nor shall any part thereof be used for any business or private purpose and no Owner shall do or suffer or permit to be done anything therein as may be or become a nuisance or cause annoyance to any other Owners or Occupiers of the Estate.

NUMBER OF UNDIVIDED SHARES ASSIGNED TO EACH RESIDENTIAL PROPERTY IN THE DEVELOPMENT

Please see table below titled "Allocation of Undivided Shares of Residential Properties in the Development".

TERM OF YEARS FOR WHICH THE MANAGER OF THE DEVELOPMENT IS APPOINTED

The Manager shall be appointed from the date of the DMC for an initial term of two (2) years and to be continued thereafter until and unless termination by the Manager or the Owners' Committee by giving not less than three (3) months' notice in writing in accordance with the terms of the DMC.

BASIS ON WHICH THE MANAGEMENT EXPENSES ARE SHARED AMONG THE OWNERS OF THE RESIDENTIAL PROPERTIES IN THE DEVELOPMENT

Where any expenditure relates to the Estate Common Areas and/or the Estate Common Facilities, the expenditure shall form part of the Management Expenses of the Estate as a whole and shall be borne by all Owners of the Estate in accordance with the proportion that the respective Management Shares of the relevant part of the Estate bear to the total number of Management Shares of the Estate less those allocated to the Estate Common Areas and the Estate Common Facilities.

BASIS ON WHICH THE MANAGEMENT FEE DEPOSIT IS FIXED

The amount of Management Deposit shall be equivalent to 3 months' Management Fee.

THE AREA (IF ANY) IN THE DEVELOPMENT RETAINED BY THE OWNER FOR THE OWNER'S OWN USE

Not applicable.

ALLOCATION OF UNDIVIDED SHARES OF RESIDENTIAL PROPERTIES IN THE DEVELOPMENT

House	Undivided Shares
79 Peak Road	754/4,979
79A Peak Road	708/4,979
77A Peak Road	671/4,979
77B Peak Road	532/4,979
77C Peak Road	528/4,979
77D Peak Road	562/4,979
77E Peak Road	688/4,979
77F Peak Road	526/4,979

Note:

- (a) Please refer to the DMC for full details. A full script of the DMC is available for inspection free of charge in the sales office.
- (b) Unless otherwise defined in the sales brochure, capitalized terms used in the above shall have the same meaning of such terms in the DMC.

發展項目的公用部分

1. 發展項目大廈公約及管理協議（「公契」）訂明下列公用地方及公用設施:-

- (i) 「屋苑公用地方」包括入口大堂、附屬地方、循環通道、行車道、斜坡、入口、出口、電錶房、錶房、通道、梯間、花槽、休憩地方及設施、訪客停車位、電訊廣播設備房、電力變壓房、高壓電配電室、低壓電錶房、通道、緊急車輛通道、梯間、整個屋苑的外牆和柵欄（不包括獨立屋的外牆和柵欄）、垃圾儲存及物料回收房、街道消防栓泵房及水缸、供公用範圍及康樂設施的機房、供道路擴闊結構的維修路徑、供安裝或使用天線廣播分發或電訊網絡設施的地方和包含屋苑公用設施的其他地方及空間及在屋苑中一個或多個部分為屋苑業主的共同使用和利益而設的其他地方及空間，惟在適當情況下，如(a)屋苑的任何部分為建築物管理條例第2條所列的「公用部分」定義的第(a)分段所涵蓋及/或(b)建築物管理條例附表1指明的任何部分並受建築物管理條例第2條所列的「公用部分」定義的第(b)分段所包括的任何部分，則該等部分都為以上的條文所涵蓋，該等部分須被視為納入並構成屋苑公用地方的一部分。僅為識別目的，屋苑公用地方於公契附圖則（其準確性經認可人士核實）中以綠色標示；但不包括屬於獨立屋的該等地方。
- (ii) 「屋苑公用設施」包括為屋苑公用地方的使用、利益或服務而設的所有設備、設施及系統。在不局限上文的一般性的原則下，包括：
- (a) 污水渠、排水渠、水道、管道、雨水渠、電線及電纜及其他設施，不論是否在管道中，而且在屋苑之內、之下、之上或穿過屋苑，或在任何時間可能如此，而水、污水、氣體、電及任何其他服務透過前述項目供應到屋苑或其中任何一個或多個部分；
- (b) 滅火裝置及設備；
- (c) 燈柱、交通燈及屋苑內照明設施；
- (d) 屋苑避雷針；
- (e) 升降機裝置及設備；及
- (f) 其他為屋苑的使用和利益而設，亦非為個別業主的使用和利益而設的設施及系統。
- (iii) 「公共公用地方及設施」指綠色範圍、綠色加黑點範圍（直至該等範圍的管有權歸還予政府之前）及該等根據批地文件或公契的條款及條件開放予公眾使用的屋苑公用地方及屋苑公用設施的部分。
- (iv) 「康樂地方及設施」指「屋苑公用地方」內的康樂地方及設施包括（但不限於）游泳池、體育館及供獨立屋住戶和其真正的訪客以康樂目的共同使用的其他地方及設施以及服務上述地方的所有配套設備、設施和結構。
- (v) 「訪客停車位」指根據第1份修訂書附表4第(29)(a)(iv)條指定為供訪客停泊車輛的停車位。

2. 屋苑公用地方及屋苑公用設施乃供所有業主的利益而設之公用地方及設施，亦供每位業主使用。

3. 除獲業主委員會批准，業主不得將屋苑公用地方及/或屋苑公用設施或其任何部分改作自用或使其受益。

4. 業主無權將其任何地方改作或指明為屋苑公用地方及/或屋苑公用設施，除非於業主大會中獲業主決議批准。業主不得將屋苑公用地方重新改作或重新指明作其自用或使其受益。

5. 業主不得使用、割破、損毀、破壞、改動或干擾屋苑公用地方或屋苑公用設施之任何部分或該地段內或上而非供該業主獨自使用、享用及受益之設備或裝置。

6. 除獲管理人事先書面同意，業主不得改變、維修、連接或以任何其他方式擾亂或影響屋苑公用地方或屋苑公用設施。

7. 業主不得將屋苑公用地方的任何部分用作晾曬或懸掛衣物或將任何垃圾箱、家具、機器、貨物或資產或其他事物放置或儲存於屋苑公用地方的任何部分之內或之上（特別提供作該等用途之空間除外）。

8. 業主不得阻塞屋苑公用地方，或於該地方放置或棄置垃圾或其他物件。業主不得使用屋苑公用地方作商業或私人用途。業主亦不得作出或容許任何對屋苑其他業主或佔用人造成滋擾的行為。

分配予發展項目中的每個住宅物業的不分割份數的數目

請見下列「發展項目住宅物業不分割份數分配表」。

發展項目的管理人的委任年期

管理人的最初任期為由公契的日期起計兩年，並於期滿後獲繼續委任，直至管理人或業主委員會根據公契條款給予對方不少於三個月書面通知以終止委任。

管理開支在發展項目中住宅物業的擁有人之間分擔的基準

全數涉及屋苑公用地方及/或屋苑公用設施之開支須計入整個屋苑之管理費內，並由屋苑所有業主按屋苑有關部分之管理份數佔屋苑所有管理份數的比例減去分配予屋苑公用地方及屋苑公用設施的管理份數計算攤分。

計算管理費按金的基準

管理費按金相當於三個月的管理費。

擁有人在發展項目中保留作自用的範圍(如有的話)

不適用。

發展項目住宅物業不分割份數分配表

獨立屋	不分割份數數目
山頂道79號	754/4,979
山頂道79A號	708/4,979
山頂道77A號	671/4,979
山頂道77B號	532/4,979
山頂道77C號	528/4,979
山頂道77D號	562/4,979
山頂道77E號	688/4,979
山頂道77F號	526/4,979

註：

(a) 全部詳情請參考公契。公契全文本可於售樓處免費參考。

(b) 除非本售樓說明書另設定義，否則上述名詞具有公契中該等名詞的相同意義。

1. The Development is constructed on The Remaining Portion of Rural Building Lot No.836 (“**the Lot**”).
2. The Lot was granted under the Government Lease dated 14 April 1965 as modified by two Modification Letters respectively dated 27 August 2010 and registered in the Land Registry by Memorial No.10083102330017 (“**the 1st Modification Letter**”) and dated 28 November 2014 and registered in the Land Registry by Memorial No.14120201900011 (“**the 2nd Modification Letter**”) (collectively “**the Land Grant**”) for a term of 75 years from 17 March 1954.
3. Clause No.(1)(a) of the Second Schedule to the 1st Modification Letter stipulates that the Grantee shall throughout the tenancy having built or rebuilt (which word refers to redevelopment as contemplated in sub-clause (b) of Clause No.(1)) in accordance with the Land Grant:
 - (i) maintain all buildings in accordance with the approved design, disposition or height and any approved building plans without variation or modification thereto; and
 - (ii) maintain all buildings erected or which may hereafter be erected in accordance with the Land Grant or any subsequent contractual variation of them, in good and substantial repair and condition and in such repair and condition deliver up the same at the expiration or sooner determination of the tenancy.
4. Clause No.(1)(b) of the Second Schedule to the 1st Modification Letter stipulates that in the event of the demolition at any time during the term granted by the Land Grant of any building then standing on the Lot or any part thereof the said Grantee shall replace the same either by sound and substantial building or buildings of the same type and of no less gross floor area or by building or buildings of such type and value as shall be approved by the Director of Lands (“**the Director**”). In the event of demolition as aforesaid the Grantee shall within one calendar month of such demolition apply to the Director for consent to carry out building works for the redevelopment of the Lot and upon receiving such consent shall within three calendar months thereof commence the necessary works of redevelopment and shall complete the same to the satisfaction of and within such time limit as is laid down by the Director.
5. Clause No.(2) of the Second Schedule to the 1st Modification Letter stipulates that the Lot or any part thereof or any building or part of any building erected or to be erected thereon shall not be used for any purpose other than for private residential purposes.
6. Clause No.(4) of the Second Schedule to the 1st Modification Letter stipulates that the Grantee may erect, construct and provide within the Lot such recreational facilities and facilities ancillary thereto (“**the Facilities**”) as may be approved in writing by the Director. The type, size, design, height and disposition of the Facilities shall also be subject to the prior written approval of the Director.
7. Clause No.(5) of the Second Schedule to the 1st Modification Letter stipulates that no tree growing on the Lot or adjacent thereto shall be removed or interfered with without the prior written consent of the Director who may, in granting consent, impose such conditions as to transplanting, compensatory landscaping or replanting as he may deem appropriate.
8. Clause No.(6)(a), (b), (c) and (e) of the Second Schedule to the 1st Modification Letter stipulates that:-
 - (a) The Lot is granted together with a right for the Grantee and his tenants, servants, visitors, workmen, and other persons authorized by him in that behalf from time to time and at all times during the term of the Land Grant for all purposes connected with the proper use and enjoyment of the Lot to pass and repass through, on, along, over, by and through those portions of Rural Building Lot Nos.299 to 306 as shown coloured yellow on the said plan (“**the Yellow Area**”) and the Government land shown coloured green on Plan A annexed to Land Grant (“**the Green Area**”).
 - (b) The Grantee shall at his own expense, in such manner, with such materials and to such standards as the Director shall require or approve, construct a paved way with the associated street furniture, traffic aids, street lighting, sewers, drains and other structures on the Green Area.
 - (c) The Grantee shall at his own expense uphold, maintain and repair the Green Area and everything forming a portion of or pertaining to it to the satisfaction of the Director and the Grantee shall be responsible for the whole as if he were the absolute owner thereof.
 - (e) The grant of the right of way referred to above shall not give the Grantee the exclusive right over the Green Area and the Government shall have the right to grant rights of way over the Green Area to the owners of any other lots in the vicinity now or in the future, or to take over the whole or any portion of the Green Area for the purposes of a public street without payment of any compensation to the Grantee.
9. Clause No.(10) of the Second Schedule to the 1st Modification Letter stipulates that where there is or has been any cutting away, removal or setting back of any land, or any building-up or filling-in or any slope treatment works of any kind whatsoever, the Grantee shall at his own expense carry out and construct such slope treatment works, retaining walls or other support, protection, drainage or ancillary or other works as may be necessary to protect and support such land within the Lot and also any adjacent or adjoining Government or leased land and to obviate and prevent any falling away, landslip or subsidence occurring thereafter. The Grantee shall at all times maintain at his own expense the said land, slope treatment works, retaining walls or other support, protection, drainage or ancillary or other works in good and substantial repair and condition to the satisfaction of the Director. In the event that as a result of works done by the grantee or owing to any other reason, any falling away, landslip or subsidence occurs at any time, the grantee shall at his own expense reinstate and make good the same to the satisfaction of the Director and shall indemnify the Government, its agents and contractors from and against all costs, charges, damages, demands and claims whatsoever which shall or may be made, suffered or incurred through or by reason of such falling away, landslip or subsidence. The Director shall be entitled by notice in writing to call upon the grantee to carry out, construct and maintain the said land, slope treatment works, retaining walls, or other support, protection, and drainage or ancillary or other works or to reinstate and make good any falling away, landslip or subsidence, and if the grantee neglects or fails to comply with the notice to the satisfaction to the Director within the period specified, the Director may execute and carry out any necessary works and the grantee shall on demand repay to the Government the cost thereof, together with any administrative and professional fees and charges.
10. Clause No.(11) of the Second Schedule to the 1st Modification Letter stipulates that the Grantee shall take or cause to be taken all proper and adequate care, skill and precautions at all times, and particularly when carrying out construction, maintenance, renewal or repair work (hereinafter referred to as “**the Works**”), to avoid causing any damage, disturbance or obstruction to any Government or other existing drain, waterway or watercourse, water main, road, footpath, street furniture, sewer, nullah, pipe, cable, wire, utility service or any other works or installations being or running upon, over, under or adjacent to the Lot, the Green Area and the Green Stippled Black Area or any combination thereof or any part thereof

(hereinafter collectively referred to as “**the Services**”). The Grantee shall prior to carrying out any of the Works make or cause to be made such proper search and enquiry as may be necessary to ascertain the present position and levels of the Services, and shall submit his proposals for dealing with any of the Services which may be affected by the Works in writing to the Director for his approval in all respects, and shall not carry out any work whatsoever until the Director shall have given his written approval to the Works and to such aforesaid proposals. The Grantee shall comply with and at his expense meet any requirements which may be imposed by the Director in respect of the Services in granting the aforesaid approval, including the cost of any necessary diversion, relaying or reinstatement. The Grantee shall at his own expense in all respects repair, make good and reinstate to the satisfaction of the Director any damage, disturbance or obstruction caused to the Lot, the Green Area and the Green Stippled Black Area or any combination thereof or any part thereof or any of the Services in any manner arising out of the Works (except for nullah, sewer, storm-water drain or water main, the making good of which shall be carried out by the Director, unless the Director elects otherwise, and the Grantee shall pay to the Government on demand the cost of such works). If the Grantee fails to carry out any such necessary diversion, relaying, repairing, making good and reinstatement of the Lot, the Green Area and the Green Stippled Black Area or any combination thereof or of any part thereof or of any of the Services to the satisfaction of the Director, the Director may carry out any such diversion, relaying, repairing, making good or reinstatement as he considers necessary and the Grantee shall pay to the Government on demand the cost of such works.

11. Clause No.(12)(a) of the Second Schedule to the 1st Modification Letter stipulates that the Grantee shall construct and maintain at his own expense and to the satisfaction of the Director such drains and channels, whether within the boundaries of the Lot or on Government land, as the Director may consider necessary to intercept and convey into the nearest stream-course, catchpit, channel or Government storm-water drain all storm-water or rain-water falling or flowing on to the Lot, and the Grantee shall be solely liable for and shall indemnify the Government and its officers from and against all actions, claims and demands arising out of any damage or nuisance caused by such storm-water or rain-water.
12. Clause No.(12)(b) of the Second Schedule to the 1st Modification Letter stipulates that the works of connecting any drains and sewers from the Lot to the Government storm-water drains and sewers, when laid and commissioned, may be carried out by the Director who shall not be liable to the Grantee for any loss or damage thereby occasioned and the Grantee shall pay to the Government on demand the cost of such connection works. Alternatively, the said connection works may be carried out by the Grantee at his own expense to the satisfaction of the Director and in such case any section of the said connection works which is constructed within Government land shall be maintained by the Grantee at his own cost and upon demand be handed over by the Grantee to the Government for future maintenance thereof at the expense of the Government and the Grantee shall pay to the Government on demand the cost of the technical audit in respect of the said connection works. The Director may, upon failure of the Grantee to maintain any section of the said connection works which is constructed within Government land, carry out such maintenance works as he considers necessary and the Grantee shall pay to the Government on demand the cost of such works.
13. Clause No.(14) of the Second Schedule to the 1st Modification Letter stipulates that where prestressed ground anchors have been installed, upon development or redevelopment of the Lot or any part thereof, the Grantee shall at his own expense carry out regular maintenance and regular monitoring of the prestressed ground anchors throughout their service life to the satisfaction of the Director and shall supply to the Director such reports and information on all such monitoring works as the Director may from time to time in his absolute discretion require. If the Grantee shall neglect or fail to carry out the required monitoring works, the Director may forthwith execute and carry out the monitoring works and the Grantee shall on demand repay to the Government the cost thereof.
14. Clause No.(19) of the Second Schedule to the 1st Modification Letter stipulates that no grave or columbarium shall be erected or made on the Lot, nor shall any human remains or animal remains whether in earthenware jars, cinerary urns or otherwise be interred therein or deposited thereon.
15. Clause No.(21)(a) of the Fourth Schedule to the 1st Modification Letter stipulates that the Grantee shall:-
 - (i) within 60 calendar months from the date of issue by the Building Authority of the first consent letter (“**the First Consent Letter**”) for demolition of the building or buildings existing on the Lot as at 27 August 2010 (or such other extended periods as may be approved by the Director), at his own expense, in such manner with such materials and to such standards, levels, alignment and design as the Director shall approve and in all respects to the satisfaction of the Director:
 - (I) lay and form those portions of future public roads shown coloured green stippled black on Plan A annexed to the Land Grant (the “**Green Stippled Black Area**”); and
 - (II) provide and construct such bridges, tunnels, over-passes, under-passes, culverts, viaducts, flyovers, pavements, roads or such other structures as the Director in his sole discretion may require (collectively “**the Structures**”) so that building, vehicular and pedestrian traffic may be carried on the Green Stippled Black Area.
 - (ii) within 60 calendar months from the date of the First Consent Letter or such other extended periods as may be approved by the Director, at his own expenses and to the satisfaction of the Director, surface, kerb and channel the Green Stippled Black Area and provide the same with such gullies, sewers, drains, fire hydrants with pipes connected to water mains, street lights, traffic signs, street furniture and road markings as the Director may require; and
 - (iii) maintain at his own expense the Green Stippled Black Area together with the Structures and all structures, surfaces, gullies, sewers, drains, fire hydrants, services, street lights, traffic signs, street furniture, road markings and plant constructed, installed and provided thereon or therein to the satisfaction of the Director until such time as possession of the Green Stippled Black Area has been delivered in accordance with Clause No.(22).
16. Clause No.(21)(b) of the Fourth Schedule to the 1st Modification Letter stipulates that in the event of the non-fulfilment of the Grantee’s obligations under Clause No.(21)(a) within the prescribed period stated therein, the Government may carry out the necessary works at the cost of the Grantee who shall pay to the Government on demand a sum equal to the cost thereof, such sum to be determined by the Director whose determination shall be final and shall be binding upon the Grantee.
17. Clause No.(22) of the Fourth Schedule to the 1st Modification Letter stipulates that for the purpose only of carrying out the necessary works specified in Clause No. (21), the Grantee shall be granted possession of the Green Stippled Black Area. The Green Stippled Black Area shall

be re-delivered to the Government on demand and in any event shall be deemed to have been re-delivered to the Government by the Grantee on the date of a letter from the Director indicating that all the covenants and conditions have been complied with to his satisfaction. The Grantee shall at all reasonable times while he is in possession of the Green Stippled Black Area allow free access over and along the Green Stippled Black Area for all Government and public vehicular and pedestrian traffic and shall ensure that such access shall not be interfered with or obstructed by the carrying out of the works whether under Clause No. (21) or otherwise.

18. Clause No.(23) of the Fourth Schedule to the 1st Modification Letter stipulates that the Grantee shall not without the prior written consent of the Director of the Lands use the Green Stippled Black Area for the purpose of storage or for the erection of any temporary structure or for any purposes other than the carrying out of the works specified in Clause No.(21).

19. Clause No.(24)(a)(i) of the Fourth Schedule to the 1st Modification Letter stipulates that the Grantee shall at all reasonable times while he is in possession of the Green Stippled Black Area permit the Director, his officers, contractors and any other persons authorized by him, the right of ingress, egress and regress to, from and through the Lot and the Green Stippled Black Area for the purpose of inspecting, checking and supervising any works to be carried out in compliance with Clause No.(21)(a) and the carrying out, inspecting, checking and supervising of the works under Clause No.(21)(b) and any other works which the Director may consider necessary in the Green Stippled Black Area.

20. Clause No.(25)(a), (c) and (d) of the Fourth Schedule to the 1st Modification Letter stipulates that:-

(a) The Grantee shall submit or cause to be submitted to the Director of Planning for his approval a landscape master plan indicating the landscaping proposals for the Lot.

(c) The Grantee shall at his own expense landscape the Lot in accordance with the approved landscape master plan and no amendment, variation, alteration, modification or substitution shall be made without the prior written consent of the Director.

(d) The Grantee shall thereafter at his own expense keep and maintain the landscaped works in a safe, clean, neat, tidy, functional and healthy condition all to the satisfaction of the Director.

21. Clause No.(26)(a) and (b) of the Fourth Schedule to the 1st Modification Letter stipulates that:-

(a) Except with prior written consent of the Director of Land, no building or structure or support for any building or structure may be erected or constructed within the area shown coloured pink hatched blue on Plan A annexed to the Land Grant (“**the Pink Hatched Blue Area**”).

(b) The Grantee shall:

(i) within 60 calendar months from the date of the First Consent Letter (or such other extended periods as may be approved by the Director), at his own expense, in such manner with such materials and to such standards, levels, alignment and design as the Director shall approve and in all respects to the satisfaction of the Director:

(I) lay and form those portions of future public roads on the Pink Hatched Blue Area; and

(II) provide and construct such bridges, tunnels, over-passes, under-passes, culverts, viaducts, flyovers, pavements,

roads or such other structures as the Director in his sole discretion may require;

so that building, vehicular and pedestrian traffic may be carried on the Pink Hatched Blue Area.

(ii) within 60 calendar months from the date of the First Consent Letter or such other extended periods as may be approved by the Director, at his own expenses and to the satisfaction of the Director, surface, kerb and channel the Pink Hatched Blue Area and provide the same with such gullies, sewers, drains, fire hydrants with pipes connected to water mains, street lights, traffic signs, street furniture and road markings as the Director may require; and

(iii) upon completion of the works stipulated in Clause No.26(b)(i) and (b)(ii), the Pink Hatched Blue Area shall be surrendered to the Government in accordance with Clause No.26(f) and (g).

22. Clause No.(26)(e) of the Fourth Schedule to the 1st Modification Letter stipulates that prior to the surrender of the whole of the Pink Hatched Blue Area under Clause No.(26)(b)(iii), the Grantee shall permit the Government and members of the public at all time and for all lawful purposes freely and without payment of any nature whatsoever to pass and repass on foot or by wheelchair on, over, along, to, from, through and over the Pink Hatched Blue Area upon compliance of Clause No.26(b)(i) and (b)(ii).

23. Clause No.(26)(g) of the Fourth Schedule to the 1st Modification Letter stipulates that the Grantee shall when called upon by the Director so to do surrender the Pink Hatched Blue Area or any part or parts thereof with vacant possession to the Government free from incumbrances, free of structures except those retaining structures for road widening purpose or similar structures approved by the Director and free of cost in all respect to the satisfaction of the Director and for this purpose the Grantee shall at his own expense execute a deed or deeds of surrender and any other documents in such form and containing such provisions as the Director may approve or require.

24. Clause No.(26)(i) of the Fourth Schedule to the 1st Modification Letter stipulates that the Grantee shall not use the Pink Hatched Blue Area or any part or parts thereof for any purpose other than the purposes permitted under Clause No. (26)(b).

(Note: pursuant to Clause No.(26)(f), the Pink Hatched Blue Area has been carved out from the Lot under the Deed Poll registered in the Land Registry by Memorial No.12020702210014. It does not form part of the Lot on which the Development is situated, and will be maintained by the Vendor prior to their surrender to the Government.)

25. Clause No.(27)(a) of the Fourth Schedule to the 1st Modification Letter stipulates that except with the prior written consent of the Director, no building or structure or support for any building or structure may be erected or constructed within the area shown coloured pink stippled red on Plan A annexed to the Land Grant (“**the Pink Stippled Red Area**”).

26. Clause No.(28)(b) of the Fourth Schedule to the 1st Modification Letter stipulates that the Grantee shall provide the Government with a free and unobstructed space within the Lot and the Pink Stippled Red Area to the satisfaction of the Director so as to facilitate the Director and the other persons to inspect, repair or maintain the Pink Hatched Blue Area or carry out any works thereto.

27. Clause No.(29)(a)(i) of the Fourth Schedule to the 1st Modification Letter stipulates that spaces shall be provided with the Lot to the satisfaction of the Director for the

parking of motor vehicles licensed under the Road Traffic Ordinance, any regulations made thereunder and any amending legislation, and belonging to the residents of the residential units in the building or buildings erected or to be erected on the Lot and their bona fide guests, visitors or invitees (“**the Residential Parking Spaces**”) at a rate to be calculated by reference to the respective size of the residential units erected or to be erected on the Lot as set out in the table in the Land Grant (unless the Director consents to a rate for or to a number of the Residential Parking Spaces different from those set out in the said table).

28. Clause No.(30)(a) of the Fourth Schedule to the 1st Modification Letter stipulates that the Residential Parking Spaces shall not be:
- (i) assigned except:
 - (I) together with undivided shares in the Lot giving the right of exclusive use and possession of a residential unit or units in the building or buildings erected or to be erected on the Lot; or
 - (II) to a person who is already the owner of undivided shares in the Lot with the right of exclusive use and possession of a residential unit or units in the buildings or buildings erected or to be erected on the Lot; or
 - (ii) underlet except to residents of the residential units in the building or buildings erected or to be erected on the Lot.

Provided that in any event not more than three in number of the total of the Residential Parking Spaces shall be assigned to the owner or underlet to the resident of any one residential unit in the building or buildings erected or to be erected on the Lot.

29. Clause No.(36)(a) of the Second Schedule to the 2nd Modification Letter stipulates that the Grantee shall at his own cost and expense and in all respects to the satisfaction of the Director repair and maintain the existing public sewer within the Lot as indicated by the line marked “C D” on the plan annexed to the Land Grant (“**the Existing Public Sewer**”) and shall not divert it without the prior written consent of the Director. In the event such a consent is given the Grantee in addition to complying with all requirements the Director may impose therefor shall at his own expense register in the Land Registry against the premises a record plan accepted by the Director indicating the alignment and dimensions of the public sewer within the premises after diversion (“**the Diverted Public Sewer**”) and shall thereafter at his own cost and expense repair and maintain the Diverted Public Sewer instead in all respects to the satisfaction of the Director and shall not divert the Diverted Public Sewer without the prior approval of the Director. For the avoidance of doubt the same obligations as above shall attach to any replacement of the Diverted Public Sewer.

For full details, please refer to the Land Grant and a copy of the Land Grant is available for inspection upon request by prospective purchasers free of charge.

1. 發展項目興建於鄉郊地段第836號餘段。（「該地段」）
2. 根據訂立於1965年4月14日的政府租契，並經一份日期為2010年8月27日以註冊摘要編號10083102330017登記於土地註冊處的修訂書（「第一份修訂書」）及一份日期為2014年11月28日以註冊摘要編號14120201900011登記於土地註冊處的修訂書（「第二份修訂書」）修改，該地段的批地年期由1954年3月17日起計75年。（統稱為「批地文件」）
3. 第一份修訂書附表2第(1)(a)條規定，承授人須在建築或重建（重建一詞指條款第(1)(b)條提及的重建）完成後在批出年期內，根據批地文件：
 - (i) 維持所有建築物遵照已批准的設計、處理或高度及任何核准建築圖則，不得更正或修改；及
 - (ii) 維持所有現有的建築物或按批地文件或其修訂書上所訂定興建未來建築物於良好狀況及作出實質的維修，並在租約完結或提前終止時以同樣的良好狀況交回。
4. 第一份修訂書附表2第(1)(b)條規定，倘若在批地文件的年期期間拆卸當時在該地段或其中任何部分上存在的任何建築物，承授人須興建相同類型和不少於原先的總樓面面積的健全及堅固的建築物或經地政總署署長（「署長」）批准的類型和價值的建築物作為代替。如果作出上述拆卸，承授人須在該拆卸的1個曆月內向署長申請同意進行該地段的重新開發之建築工程，並在收到上述同意後的3個曆月內展開重新開發所必要的工程和署長規定的時限內完成工程，達致署長滿意。
5. 第一份修訂書附表2第(2)條規定，該地段或其中任何部分或在其上的任何已興建或將興建的任何建築物或任何建築物部分不得用作私人住宅用途以外的其他用途。
6. 第一份修訂書附表2第(4)條規定，買方可在該地段內搭建、建造和提供署長書面批准的康樂設施及其輔助設施（「設施」）。該等設施的類型、尺寸、設計、高度及方位須經署長預先書面批准。
7. 第一份修訂書附表2第(5)條規定，除獲署長事先書面同意外（署長於簽發同意書時可施加其認為適當的移植、補償美化或重植條件），承授人不得移除或干擾於該地段或鄰近地方生長的樹木。
8. 第一份修訂書附表2第(6)(a)、(b)、(c)及(e)條規定：-
 - (a) 該地段連同一項權利批授承授人及其租客、傭僕、訪客、工人及其他獲其就此獲授權人士於批地文件所協定的批地年期內不時及時刻均有權在署長批准的高度通行及再通行、往來及穿越鄉郊地段第299至306號於該附圖以黃色顯示的範圍（以下稱為「黃色範圍」）及政府土地於批地文件隨附圖則A上以綠色顯示的範圍（「綠色範圍」），以作所有關乎正當使用及享用該地段的用途。
 - (b) 承授人須自費按署長要求或認可的方式、物料及標準，於綠色範圍上興建一條鋪平道路及相關的街道設施、交通輔助設施、街道照明、污水渠、排水渠及其他構築物。
 - (c) 承授人須自費維持、保養及維修綠色範圍及全部形成該範圍的一部分或相關部分，並達致署長全面滿意，而承授人須如同綠色範圍的全權擁有人負責整個綠色範圍。
 - (e) 上述通行權並非授與承授人享用綠色範圍的專用權，而政府有權於現在或將來授予其他鄰近地段的業主通越綠色範圍的通行權，或收回全部或部份綠色範圍以作為公共街道而不須向承授人作出任何賠償。
9. 第一份修訂書附表2第(10)條規定，倘若任何土地遭切去、拆除或重新設置，或倘若任何建造、填土或任何斜坡處理工程經進行，承授人須自費開展和建設可能需要的斜坡處理工程、擋土牆或其他承托、防護、排水或任何其他附屬工程，以確保該地段或毗鄰該地段的政府土地或租用土地的安全，及防止和避免其後出現山泥傾瀉或地陷的情況。承授人需時刻自費維持該地段、斜坡處理工程、擋土牆或其他承托、防護、排水或任何其他附屬工程於良好狀況，達致署長滿意。倘若因承授人的工程或其他原因於任何時候造成的山泥傾瀉或地陷，承授人需自費修復，達致署長滿意。承授人如因山泥傾瀉或地陷以致政府、其代理及承判商招致任何費用、收費、賠償、索求及索償，承授人必須向彼等彌償。署長可書面要求承授人進行、建設及保養該地段、斜坡處理工程、擋土牆或其他承托、防護、排水或任何其他附屬工程，或修復山泥傾瀉或地陷。倘若承授人忽視或未能於指定的期限內遵守該要求，達致署長滿意，署長可自行執行及進行所需工程，承授人需連同任何行政和專業費用及收費償還該等費用予政府。
10. 第一份修訂書附表2第(11)條規定，承授人須在任何時候，特別是在進行建造、保養、翻新、維修工程（「該等工程」）期間，採取或促使他人採取一切適當及充分的謹慎、技巧及預防措施，以避免對任何政府擁有或其他現存排水渠、水路或水道、總水管、道路、行人路、街道設施、污水渠、明渠、管道、電纜、電線、公用服務設施或任何其他於該地段、綠色範圍、綠色加黑點範圍、或該等土地之任何組合或任何部分上面、之上、之下或毗鄰進行的工程或運作的裝置（「該等服務」）造成任何損壞、干擾或阻塞。承授人須於進行任何該等工程前進行或促使他人進行有需要的適當勘探及查究，以確定該等服務的現況及程度，並就如何處理任何可受該等工程影響的該等服務向署長提交書面建議供其在所有方面批准，且於署長書面同意該等工程及上述建議前不得進行任何工程。承授人須遵守及自費履行署長於給予上述批准時就該等服務施加的任何要求，包括任何有需要的改道、重鋪或修復費用。承授人須自費在各方面維修、彌補及修復因該等工程而對該地段、綠色範圍、綠色加黑點範圍、或該等土地之任何組合或任何部分、或任何該等服務（明渠、污水渠、雨水渠或總水管除外，其修復工程須由署長進行（除非署長另有決定），而承授人須應要求向政府支付該等修復工程之費用）造成之任何損壞、干擾或阻塞，達致署長滿意。若承授人未能對該地段、綠色範圍、綠色加黑點範圍、或該等土地之任何組合或任何部分、或任何該等服務進行任何所需的改道、重鋪、維修、彌補及修復工程達致署長滿意，署長可進行他認為有需要的任何該等改道、重鋪、維修、修復或彌補工程，且承授人須應要求向政府支付該等上述工程的費用。
11. 第一份修訂書附表2第(12)(a)條規定，承授人應以署長滿意的方式，按署長視為需要，自費在該地段邊界範圍或政府土地上建造和保養排水渠及渠道，以截流及輸送所有落下或流入該地段的暴雨或雨水至最近的河道、集水溝、渠道或政府雨水渠。如因暴雨或雨水造成損害或滋擾而引起或招致任何訴訟、索償及需索，承授人需獨力承擔責任並向政府及其官員作出彌償。
12. 第一份修訂書附表2第(12)(b)條規定，接駁該地段任何排水渠及污水管到政府雨水渠及污水管（當鋪妥及啟用後）的工程可由署長執行而署長不須為其造成的任何損失或損害向承授人承擔任何責任，且承授人須在政府要求時支付該等接駁工程的費用。承授人亦可以署長滿意的方式自費進行接駁工程。於該情況下，建於政府官地的任何一段接駁工程將由承授人自費保養，並在政府要求下移交政府及由其自費執行日後保養，惟承授人須應政府要求下支付上述接駁工程的技術審查費用。如果承授人未能保養上述連接工程中在政府土地內修建的任何一段，署長可進行其認為必要的保養工程，承授人須在要求時向政府支付上述工程費用。
13. 第一份修訂書附表2第(14)條規定，如於該地段或其任何部分的發展或重建時有安裝預應力地錨，則承授人須在預應力地錨的整個使用壽命內，自費定期保養及監控預應力地錨，並達致署長滿意。承授人還須向署長提供署長可不時依其絕對酌情權要求的、有關所有該等監控作業的報告和資料。倘若承授人忽視或未能於進行根據要求的監控作業，署長可立即自行執行及進行所需的監控作業，承授人須償還該等費用予政府。
14. 第一份修訂書附表2第(19)條規定，該地段不得興建或提供墳墓或靈灰安置所，亦不得用以安葬人類遺骸或動物遺骸（不論

是安葬或存放在陶質盛器、骨灰甕內或以其他方式存放)。

15. 第一份修訂書附表4第(21)(a)條規定，承授人須:-

(i) 在屋宇署為拆卸該地段上於2010年8月27日存在的建築物而發出的第一份同意書(「**第一份同意書**」)的日期起60個曆月內(或經署長批准之延期)，自費以署長批准的方式及物料、標準、高度、定線和設計進行下列工程，以全面令署長滿意：

(I) 鋪設及興建在批地文件隨附圖則A上以綠色加黑點顯示的範圍(「**綠色加黑點範圍**」)的未來公共道路部份；及

(II) 提供及興建指定天橋、隧道、高架道路、地下通道、溝渠、高架橋、行車天橋、行人路、道路或署長運用絕對酌情權下規定的其他構築物(統稱「**構築物**」)

致使建築、車輛及行人交通將可於綠色加黑點範圍進行。

(ii) 在第一份同意書的日期起60個曆月內(或經署長批准之延期)，在署長滿意之情況下自費在綠色加黑點範圍鋪設表面、建造路緣及渠道，並提供署長規定的溝渠、污水渠、排水渠、消防栓連同接駁至總喉的喉管、街燈、交通標誌、街道設施及道路標記；及

(iii) 自費保養綠色加黑點範圍連同該等構築物以及所有建造、安裝及提供在其上或內的構築物、路面、溝渠、污水渠、排水渠、消防栓、服務、街燈、交通標誌、街道設施、道路標記及植物，達致署長滿意，直至綠色加黑點範圍之管有權根據條款第(22)條交還為止。

16. 第一份修訂書附表4第(21)(b)條規定，若承授人不在指定時間內履行條款第(21)(a)條之責任，政府可進行所需之工程，惟費用由承授人支付，就此承授人須應政府要求向政府繳付一筆數額等於上述工程費用之款項，該數額由署長釐定，此決定為最終決定並對承授人具約束力。

17. 第一份修訂書附表4第(22)條規定，僅為了進行條款第(21)條指定的必要工程，承授人於第一份同意書簽立之日獲授予綠色加黑點範圍的管有權。承授人須應政府要求交還綠色加黑點範圍，但無論如何，若署長致函發出信件表示批地文件各項條件已妥為履行達致其滿意，綠色範圍即被視為已於發信當天由承授人交回政府。承授人須在其管有綠色加黑點範圍的所有合理時間內容許所有政府及公眾車輛及行人自由穿越、通往及前往綠色加黑點範圍，並確保其通行不受條款第(21)條或其他條款所進行的工程的干擾或阻礙。

18. 第一份修訂書附表4第(23)條規定，未經署長事先書面同意，承授人不得使用綠色加黑點範圍作儲存或架設任何臨時構築物，又或進行條款第(21)條所指定之工程以外的其他用途。

19. 第一份修訂書附表4第(24)(a)(i)條規定，承授人須於管有綠色加黑點範圍期間的所有合理時間內，允許署長、其官員、承辦商及任何其他獲其授權人士進出及再進出和行經及通過該地段及綠色加黑點範圍，以便檢查、查核及監督任何遵照條款第(21)(a)條規定進行的工程及執行、檢查、查核及監督任何遵照條款第(21)(b)條規定進行的工程，以及署長認為必須在綠色加黑點範圍進行的其他工程。

20. 第一份修訂書附表4第(25)(a)、(c)及(d)條規定:-

(a) 承授人須向規劃署署長呈交或安排呈交一份園景設計總圖說明有關該地段園景設計的方案，並就該園景設計總圖取得規劃署署長批准。

(c) 承授人須自費按照已獲批准的園景設計總圖在該地段進行園藝工程。除獲署長事先書面同意外，承授人不得對已獲批准的園景設計總圖作出任何修正、變動、修改、更新或取替。

(d) 承授人須於其後自費保持及維持該園藝工程於安全、清潔、整齊、井然、實用及良好之狀況並達致署長滿意。

21. 第一份修訂書附表4第(26)(a)及(b)條規定:-

(a) 除非事前獲得署長書面同意，不得在批地文件隨附圖則A上以粉紅色加藍色斜線顯示的範圍(「**粉紅色加藍色斜線範圍**」)內興建或任何建築物或構築物或該建築物或構築物的支撐物。

(b) 承授人須：

(i) 在第一份同意書的日期起60個曆月內(或經署長批准之延期)，自費以署長批准的方式及物料、標準、高度、定線和設計進行下列工程，以全面令署長滿意：

(I) 鋪設及興建在粉紅色加藍色斜線範圍的未來公共道路部份；及

(II) 提供及興建指定天橋、隧道、高架道路、地下通道、溝渠、高架橋、行車天橋、行人路、道路或署長運用絕對酌情權下規定的其他構築物；

致使建築、車輛及行人交通將可於粉紅色加藍色斜線範圍進行。

(ii) 在第一份同意書的日期起60個曆月內(或經署長批准之延期)，在署長滿意之情況下自費在粉紅色加藍色斜線範圍鋪設表面、建造路緣及渠道，並提供署長規定的溝渠、污水渠、排水渠、消防栓連同接駁至總喉的喉管、街燈、交通標誌、街道設施及道路標記；及

(iii) 在完成條款第(26)(b)(i)及(b)(ii)條提及的工程後，根據條款第(26)(f)及(g)條將粉紅色加藍色斜線範圍交還予政府。

22. 第一份修訂書附表4第(26)(e)條規定，承授人須在根據條款第(26)(b)(iii)條將整個粉紅色加藍色斜線範圍交還予政府前，並完成條款第(26)(b)(i)及(b)(ii)提及的工程後，允許政府和公眾在所有時間免費進出，自由地步行或乘坐輪椅出入通行及再通行、以往來及穿越粉紅色加藍色斜線範圍，以作任何合法用途。

23. 第一份修訂書附表4第(26)(g)條規定，承授人須在署長提出要求時自費向政府交還署長所指定的粉紅色加藍色斜線範圍或其任何部分(連同其空置管有權)，且其不受產權負擔影響，其上並無任何構築物(除保留作道路擴闊用途之構築物或類似經署長批准的構築物外)，而政府無需支付任何款項或賠償予承授人。為了按上述交還粉紅色加藍色斜線範圍，承授人須自費簽署一份土地交還契據及任何其他文件，其格式及所載條文須由署長批准或規定。

24. 第一份修訂書附表4第(26)(i)條規定，承授人不可將粉紅色加藍色斜線範圍或其任何部分用作任何除進行條款第(26)(b)條所述的工程以外的目的。

(備註：根據條款第(26)(f)條，粉紅色加藍色斜線範圍已按照於土地註冊處註冊的分割契據(註冊編號12020702210014)從該地段分割出來。粉紅色加藍色斜線範圍並不構成發展項目所位於的該地段的一部分，並且於交還予政府前將由賣方進行保養工作。)

25. 第一份修訂書附表4第(27)(a)條規定，除得到署長事先書面批准，批地文件附圖A內顯示之粉紅色加紅點範圍(「**粉紅色加紅點範圍**」)不得豎立或興建任何建築物或結構或建築物或結構的支撐物。

26. 第一份修訂書附表4第(28)(b)條規定，承授人須在該地段及粉紅色加紅點範圍內向政府提供一個空置且不受阻塞的空間，並達致署長滿意，以協助署長或其他人勘察、維修或保養粉紅色加藍色斜線範圍或在該範圍進行任何工程。

27. 第一份修訂書附表4第(29)(a)(i)條規定，該地段內須提供停車位供已按《道路交通條例》、其附屬規例及任何修訂法例

獲發牌及屬於已建或將建於該地段上之建築物的住宅單位的住客及彼等之真正客人、訪客或獲邀請人之車輛停泊（下稱「住宅停車位」），以達致署長滿意，而停車位的比率須參照已載列於該批地文件之表格上已建或將建於該等分段上之住宅單位的個別大小計算，除非署長同意與上述表格所列不同之住宅停車位比率或數目。

28. 第一份修訂書附表4第(30)(a)條規定，住宅停車位不可：

(i) 轉讓，除非：

- (I) 連同賦予該地段上已建或將建之建築物中之住宅單位獨有享用及管有權之不分割業權份數一併轉讓；或
- (II) 該承讓人已經擁有該地段上已建或將建之建築物中之住宅單位獨有享用及管有權之不分割業權份數；或

(ii) 轉租，除非租予該地段上已建或將建之建築物中之住宅單位的住戶。

但無論如何，轉讓予任何一個該地段上已建或將建之建築物中之住宅單位的業主或轉租予任何一個該地段上已建或將建之建築物中之住宅單位的住戶之住宅停車位及電單車停車位總數不得超過三個。

29. 第二份修訂書附表2第(36)(a)條規定，承授人需自費維修及保養該地段的現有公眾污水渠（如批地文件隨附圖則上以「CD」線條所顯示的）（「現有公眾污水渠」），並全面達致署長滿意，除獲署長事先書面同意外，承授人不得進行該污水管的改道工程。倘若承授人獲得上述同意及履行署長批出上述同意時就該等服務施加的所有要求後，須自費到土地註冊處就該地段登記獲署長批准的圖則，表明該公眾污水管道改道後的定線和尺寸（「經改道公眾污水渠」），並其後自費維修及保養經改道公眾污水渠以作替代，以全面令署長滿意，除獲署長事先同意外，承授人不得進行經改道公眾污水渠的改道工程。為免生疑問，承授人對任何替換經改道公眾污水渠負有的相同義務。

請參考批地文件了解詳情。準買家可免費查閱批地文件的副本。

A. FACILITIES THAT ARE REQUIRED UNDER THE LAND GRANT TO BE CONSTRUCTED AND PROVIDED FOR THE GOVERNMENT, OR FOR PUBLIC USE

1. The Green Area as referred to in Clauses Nos.(6) and (11) of the Second Schedule to the 1st Modification Letter:

(1) Provisions of the Land Grant

Clause No.(6) of the Second Schedule to the 1st Modification Letter stipulates that:-

- (a) The premises hereby expressed to be demised is granted together with a right for the said Lessee and his tenants, servants, visitors, workmen and other persons authorized by him in that behalf from time to time and at all times during the term hereby granted for all purposes connected with the proper use and enjoyment of the premises hereby expressed to be demised to pass and repass, on, along, over, by and through those portions of Rural Building Lot Nos.299 to 306 as shown coloured yellow on the said plan (hereinafter referred to as **“the Yellow Area”**) and the Government land shown coloured green on the plan marked “PLAN A” annexed hereto (hereinafter referred to as **“the Green Area”**) at such levels as may be approved by the Director.
- (b) The said Lessee shall at his own expense, in such manner, with such materials and to such standards as the Director shall require or approve, construct a paved way with the associated street furniture, traffic aids, street lighting, sewers, drains and other structures on the Green Area over and along which a right of way referred to in sub-clause (a) of this Clause is given.
- (c) The said Lessee shall at his own expense uphold, maintain and repair the Green Area and everything forming a portion of or pertaining to it, all to be done to the satisfaction of the Director and the said Lessee shall be responsible for the whole as if he were the absolute owner thereof.
- (d) Any alteration to any public road absorbing a portion of the Green Area over and along which a right of way is given or affecting the gradient thereof, shall not give rise to any claim by the said Lessee who shall at his own expense carry out all consequent alterations to the paved way constructed by him to the satisfaction of the Director.
- (e) The grant of the right of way referred to in sub-clause (a) of this Clause shall not give the said Lessee the exclusive right over the Green Area. The Government shall have the right to grant rights of way over the Green Area to the owners of any other lots in the vicinity now or at any time in the future, or to take over the whole or any portion of the Green Area for the purposes of a public street without payment of any compensation to the said Lessee or to other owners to whom rights of way over the whole or any portion of the Green Area may have been granted.
- (f) In the event of the non-fulfilment of the said Lessee's obligations under sub-clauses (b) and (c) of this Clause, the Government may carry out the necessary construction, maintenance and repair works at the cost of the said Lessee who shall pay to the Government on demand a sum equal to the cost thereof, such sum to be determined by the Director whose determination shall be final and shall be binding upon the said Lessee.

- (g) Notwithstanding the grant of the right of way referred to in sub-clause (a) of this Clause, the Government shall have the full right and power, upon giving to the said Lessee, not less than fourteen days written notice (save in case of emergency) to lay, install, relay, divert, remove, re-provision, replace, inspect, operate, repair, maintain and renew any Government or other drain, culvert, waterway or watercourse, sewer, nullah, water main, pipe, cable, wire, line, utility service or other works or installations (all together hereinafter referred to as **“the Green Area Services”**) which are now or may hereafter be upon, over, under or adjacent to the Green Area as the Director may in his absolute discretion deem fit, making good any and all damages caused thereby, and the Director, his officers, contractors and any other persons authorized by him, his or their workmen with or without tools, equipment, plant, machinery or motor vehicles shall have the right of free ingress, egress and regress at all times to and from the Green Area for the purposes aforesaid. The said Lessee shall not disturb or allow anybody to disturb the Green Area services without prior written approval from the Director. Save in respect of making good any and all damage caused by any exercise of the aforesaid rights and powers, the Government, the Director, his officers, contractors and any other persons authorized by him, his or their workmen shall have no liability in respect of any loss, damage, nuisance or disturbance whatsoever caused to or suffered by the said Lessee arising out of or incidental to the exercise of the rights conferred under this sub-clause, and no claim nor objection shall be made against him or them by the said Lessee.

Clause No.(11) of the Second Schedule to the 1st Modification Letter stipulates that:-

The said Lessee shall take or cause to be taken all proper and adequate care, skill and precautions at all times, and particularly when carrying out construction, maintenance, renewal or repair work (hereinafter referred to as **“the Works”**), to avoid causing any damage, disturbance or obstruction to any Government or other existing drain, waterway or watercourse, water main, road, footpath, street furniture, sewer, nullah, pipe, cable, wire, utility service or any other works or installations being or running upon, over, under or adjacent to the premises hereby expressed to be demised, the Green Area and the Green Stippled Black Area or any combination thereof or any part thereof (hereinafter collectively referred to as **“the Services”**). The said Lessee shall prior to carrying out any of the Works make or cause to be made such proper search and enquiry as may be necessary to ascertain the present position and levels of the Services, and shall submit his proposals for dealing with any of the Services which may be affected by the Works in writing to the Director for his approval in all respects, and shall not carry out any work whatsoever until the Director shall have given his written approval to the Works and to such aforesaid proposals. The said Lessee shall comply with and at his expense meet any requirements which may be imposed by the Director in respect of the Services in granting the aforesaid approval, including the cost of any necessary diversion, relaying or reinstatement. The said Lessee shall at his own expense in all respects repair, make good and reinstate to the satisfaction of the Director any damage, disturbance or obstruction caused to the premises hereby expressed to be demised, the Green Area and the Green Stippled Black Area or any combination thereof or any part thereof or any of the Services in any manner

arising out of the Works (except for nullah, sewer, storm-water drain or water main, the making good of which shall be carried out by the Director, unless the Director elects otherwise, and the said Lessee shall pay to the Government on demand the cost of such works). If the said Lessee fails to carry out any such necessary diversion, relaying, repairing, making good and reinstatement of the premises hereby expressed to be demised, the Green Area and the Green Stippled Black Area or any combination thereof or of any part thereof or of any of the Services to the satisfaction of the Director, the Director may carry out any such diversion, relaying, repairing, making good or reinstatement as he considers necessary and the said Lessee shall pay to the Government on demand the cost of such works.

(2) Provisions of the Deed of Mutual Covenant

Clause 1.1 stipulates that:-

In this Deed the following words and expressions shall have the following meanings ascribed to them whenever the context so permits:-

...

“Green Area”

The area shown coloured Green on the plan marked “PLAN A” annexed to the 1st Modification Letter which areas which is required to be upheld, maintained and repaired in accordance with Clause (6) of the Second Schedule to the 1st Modification Letter.

...

“Public Common Areas and Facilities”

The Green Area, the Green Stippled Black Area (of which until possession of the same is redelivered to the Government).

Clause 3.1.1 stipulates that:-

The Owner of a House shall have the benefit of the following easements, rights and privileges subject to the provisions in this Deed including the provisions of the rights of the Manager and the First Owner as herein provided :-

- (a) full right and liberty for each Owner of a House, his tenants, servants, agents and licensees (in common with all persons having the like right and subject to the rights of the general public in respect of the Public Common Areas and Facilities) to go pass and repass over and along and use the Estate Common Areas and the Estate Common Facilities for all purposes connected with the proper use and enjoyment of his House.

Clause 6.2.1 stipulates that:-

...Without in any way limiting the generality of the foregoing the Manager shall have the following duties :-

...

- (14)To prevent so far as is possible any refuse or other matter being deposited, washed, eroded or falling from the Estate into any part of the public highway, sewers, drains, nullahs or other Government property and to remove any such matter therefrom and to ensure that no damage is done to any drains, waterways, watercourses, footpaths, sewers, nullahs, pipes, cables, wires, utility services or other works being in, under, over or adjacent to the Land or any part or parts thereof by reason of any maintenance or other works carried out by the Manager as herein provided and to make good any such damage.

...

- (58)To maintain, repair, reinstate and make good the Public Common Areas and Facilities pursuant to and subject to the provisions of the Government Lease.

Clause 6.4.1 stipulates that:-

The Owners of the Estate shall pay to the Manager monthly in advance in the manner hereinafter provided the Management Expenses which shall be made up of the following :-

...

- (w) The expenses for the maintenance, repair and reinstatement of and making good the Green Area and the Green Stippled Black Area.

- (3) The general public has the right to use those facilities or open spaces (if any) mentioned above in accordance with the Land Grant.

2. The Green Stippled Black Area as referred to in Clauses Nos.(21) to (24) of the Fourth Schedule to the 1st Modification Letter:

(1) Provisions of the Land Grant

Clause No.(21)(a) of the Fourth Schedule to the 1st Modification Letter stipulates that:-

(a) The said Lessee shall:

- (i) within 60 calendar months from the date of issue by the Building Authority of the first consent letter (hereinafter referred to as “**the First Consent Letter**”) for demolition of the building or buildings existing on the premises hereby expressed to be demised as at the 27th day of August 2010 (or such other extended periods as may be approved by the Director), at his own expense, in such manner with such materials and to such standards, levels, alignment and design as the Director shall approve and in all respects to the satisfaction of the Director:

- (I) lay and form those portions of future public roads shown coloured green stippled black on the plan marked “PLAN A” annexed hereto (hereinafter referred to as “**the Green Stippled Black Area**”); and
- (II) provide and construct such bridges, tunnels, over-passes, under-passes, culverts, viaducts, flyovers, pavements, roads or such other structures as the Director in his sole discretion may require (hereinafter collectively referred to as “**the Structures**”)

so that building, vehicular and pedestrian traffic may be carried on the Green Stippled Black Area;

- (ii) within 60 calendar months from the date of the First Consent Letter or such other extended periods as may be approved by the Director, at his own expenses and to the satisfaction of the Director, surface, kerb and channel the Green Stippled Black Area and provide the same with such gullies, sewers, drains, fire hydrants with pipes connected to water mains, street lights, traffic signs, street furniture and road markings as the Director may require; and

- (iii) maintain at his own expense the Green Stippled Black Area together with the Structures and all structures, surfaces, gullies, sewers, drains, fire hydrants, services, street lights, traffic signs, street furniture, road markings and plant constructed, installed and provided thereon or therein to the satisfaction of the Director until such time as possession of the Green Stippled Black Area has been delivered in accordance with Clause No.(22) hereof.
- (b) In the event of the non-fulfilment of the said Lessee's obligations under sub-clause (a) of this Clause within the prescribed period stated therein, the Government may carry out the necessary works at the cost of the said Lessee who shall pay to the Government on demand a sum equal to the cost thereof, such sum to be determined by the Director whose determination shall be final and shall be binding upon the said Lessee.
- (c) The Director shall have no liability in respect of any loss, damage, nuisance or disturbance whatsoever caused to or suffered by the said Lessee or any other person whether arising out of or incidental to the fulfilment of the said Lessee's obligations under sub-clause (a) of this Clause or the exercise of the rights by the Government under sub-clause (b) of this Clause or otherwise, and no claim for compensation shall be made against the Government or the Director or his authorized officer by the said Lessee in respect of any such loss, damage, nuisance or disturbance.

Clause No.(22) of the Fourth Schedule to the 1st Modification Letter stipulates that:-

For the purpose only of carrying out the necessary works specified in Clause No. (21) hereof, the said Lessee shall on the date of the First Consent Letter be granted possession of the Green Stippled Black Area. The Green Stippled Black Area shall be re-delivered to the Government on demand and in any event shall be deemed to have been re-delivered to the Government by the said Lessee on the date of a letter from the Director indicating that all the covenants and conditions herein contained have been complied with to his satisfaction. The said Lessee shall at all reasonable times while he is in possession of the Green Stippled Black Area allow free access over and along the Green Stippled Black Area for all Government and public vehicular and pedestrian traffic and shall ensure that such access shall not be interfered with or obstructed by the carrying out of the works whether under Clause No.(21) hereof or otherwise.

Clause No.(23) of the Fourth Schedule to the 1st Modification Letter stipulates that:-

The said Lessee shall not without the prior written consent of the Director use the Green Stippled Black Area for the purpose of storage or for the erection of any temporary structure or for any purposes other than the carrying out of the works specified in Clause No.(21) hereof.

Clause No.(24) of the Fourth Schedule to the 1st Modification Letter stipulates that:-

- (a) The said Lessee shall at all reasonable times while he is in the possession of the Green Stippled Black Area:
 - (i) permit the Director, his officers, contractors and any other persons authorized by him, the right of ingress, egress and regress to, from and through the premises hereby expressed to be demised and the Green Stippled Black Area for the purpose of inspecting, checking

and supervising any works to be carried out in compliance with Clause No.(21)(a) hereof and the carrying out, inspecting, checking and supervising of the works under Clause No.(21)(b) hereof and any other works which the Director may consider necessary in the Green Stippled Black Area;

- (ii) permit the Government and the relevant public utility companies authorized by the Government the right of ingress, egress and regress to, from and through the premises hereby expressed to be demised and the Green Stippled Black Area as the Government or the relevant public utility companies may require for the purpose of any works to be carried out in, upon or under the Green Stippled Black Area or any adjoining land including but not limited to the laying and subsequent maintenance of all pipes, wire, conduits, cable-ducts and other conducting media and ancillary equipment necessary for the provision of telephone, electricity, gas (if any) and other services intended to serve the premises hereby expressed to be demised or any adjoining or neighbouring land or premises. The said Lessee shall co-operate fully with the Government and also with the relevant public utility companies duly authorized by the Government on all matters relating to any of the aforesaid works to be carried out within the Green Stippled Black Area; and
- (iii) permit the officers of the Water Authority and such other persons as may be authorized by them the right of ingress, egress and regress to, from and through the premises hereby expressed to be demised and the Green Stippled Black Area as the officers of the Water Authority or such authorized persons may require for the purpose of carrying out any works in relation to the operation, maintenance, repairing, replacement and alteration of any other waterworks installations within the Green Stippled Black Area.

- (b) The Government shall have no liability in respect of any loss, damage, nuisance or disturbance whatsoever caused to or suffered by the said Lessee or any other person arising out of or incidental to the exercise of the rights by the Government, its officers, agents, contractors, and any other persons or public utility companies duly authorized under sub-clause (a) of this Clause.

(2) Provisions of the Deed of Mutual Covenant

Clause 1.1 stipulates that:-

In this Deed the following words and expressions shall have the following meanings ascribed to them whenever the context so permits:-

...

“Green Stippled Black Area”

The portions of the future public roads shown coloured Green Stippled Black on the plan marked “PLAN A” annexed to the 1st Modification Letter which is required to be laid and formed in accordance with Clause (21)(a)(i)(I) of the Fourth Schedule to the 1st Modification Letter.

“Public Common Areas and Facilities”

The Green Area, the Green Stippled Black Area (of which until possession of the same is redelivered to the Government) and those parts of the Estate Common Areas and Estate Common Facilities which are open for public use pursuant to the terms and conditions of the Government Lease or this Deed.

Clause 6.2.1 stipulates that:-

...Without in any way limiting the generality of the foregoing the Manager shall have the following duties :-

...

(14) To prevent so far as is possible any refuse or other matter being deposited, washed, eroded or falling from the Estate into any part of the public highway, sewers, drains, nullahs or other Government property and to remove any such matter therefrom and to ensure that no damage is done to any drains, waterways, watercourses, footpaths, sewers, nullahs, pipes, cables, wires, utility services or other works being in, under, over or adjacent to the Land or any part or parts thereof by reason of any maintenance or other works carried out by the Manager as herein provided and to make good any such damage.

...

(58) To maintain, repair, reinstate and make good the Public Common Areas and Facilities pursuant to and subject to the provisions of the Government Lease.

Clause 6.4.1 stipulates that:-

The Owners of the Estate shall pay to the Manager monthly in advance in the manner hereinafter provided the Management Expenses which shall be made up of the following :-

...

(w) The expenses for the maintenance, repair and reinstatement of and making good the Green Area and the Green Stippled Black Area.

(3) The general public has the right to use those facilities or open spaces (if any) mentioned above in accordance with the Land Grant.

3. The Pink Hatched Blue Area as referred to in Clause No.(26) of the Fourth Schedule to the 1st Modification Letter:

(1) Provisions of the Land Grant

Clause No.(26) of the Fourth Schedule to the 1st Modification Letter stipulates that:-

(a) Except with prior written consent of the Director, no building or structure or support for any building or structure may be erected or constructed within the area shown coloured pink hatched blue on the plan marked "PLAN A" annexed hereto (hereinafter referred to as "**the Pink Hatched Blue Area**").

(b) The said Lessee shall:

(i) within 60 calendar months from the date of the First Consent Letter (or such other extended periods as may be approved by the by the Director), at his own expense, in such manner with such materials and to such standards, levels, alignment and design as the Director shall approve and in all respects to the satisfaction of the Director:

(l) lay and form those portions of future

public roads on the Pink Hatched Blue Area; and

(II) provide and construct such bridges, tunnels, over-passes, under-passes, culverts, viaducts, flyovers, pavements, roads or such other structures as the Director in his sole discretion may require;

so that building, vehicular and pedestrian traffic may be carried on the Pink Hatched Blue Area;

(ii) within 60 calendar months from the date of the First Consent Letter or such other extended periods as may be approved by the Director, at his own expenses and to the satisfaction of the Director, surface, kerb and channel the Pink Hatched Blue Area and provide the same with such gullies, sewers, drains, fire hydrants with pipes connected to water mains, street lights, traffic signs, street furniture and road markings as the Director may require; and

(iii) upon completion of the works stipulated in sub-clauses (b)(i) and (b)(ii) of this Clause, the Pink Hatched Blue Area shall be surrendered to the Government in accordance with sub-clauses (f) and (g) of this Clause.

(c) In the event of the non-fulfilment of the said Lessee's obligations under sub-clauses (b)(i) and (b)(ii) of this Clause within the prescribed period stated therein, the Government may carry out the necessary works at the cost of the said Lessee who shall pay to the Government on demand a sum equal to the cost thereof, such sum to be determined by the Director whose determination shall be final and shall be binding upon the said Lessee.

(d) The Director shall have no liability in respect of any loss, damage, nuisance or disturbance whatsoever caused to or suffered by the said Lessee or any other person whether arising out of or incidental to the fulfilment of the said Lessee's obligations under sub-clause (b) of this Clause or the exercise of the rights by the Government under sub-clause (c) of this Clause or otherwise, and no claim for compensation shall be made against the Government or the Director or his authorized officer by the said Lessee in respect of any such loss, damage, nuisance or disturbance.

(e) Prior to the surrender of the whole of the Pink Hatched Blue Area to the Government in accordance with sub-clause (g) of this Clause, the said Lessee shall permit the Government and members of the public at all time and for all lawful purposes freely and without payment of any nature whatsoever to pass and repass on foot or by wheelchair on, over, along, to, from, through and over the Pink Hatched Blue Area upon compliance of sub-clause (b)(i) and (b)(ii) of this Clause.

...

(g) The said Lessee shall when called upon by the Director so to do surrender the Pink Hatched Blue Area or any part or parts thereof as shall be specified by the Director with vacant possession to the Government free from incumbrances, free of structures except those retaining structures for road widening purpose or similar structures approved by the Director and free of cost in all respects to the satisfaction of the Director and for this purpose the said Lessee shall at his own expense execute a deed or deeds of surrender and any other documents in

such form and containing such provisions as the Director may approve or require. The said Lessee shall have no right to claim against the Government for any loss, damage or compensation whatsoever directly or indirectly arising out of or in connection with the surrender.

- (h) Save and except for the Building Mortgage and surrender of the Pink Hatched Blue Area in compliance with sub-clause (g) of this Clause, the said Lessee shall not assign, mortgage, charge, demise, underlet, part with the possession of or otherwise dispose of or encumber the Pink Hatched Blue Area or any part thereof or any interest therein or enter into any agreement so to do.
- (i) The said Lessee shall not use the Pink Hatched Blue Area or any part or parts thereof for any purpose other than carrying out of the works specified in sub-clause (b) of this Clause, the passage of pedestrians or such other purposes as the Director may approve. No parking of motor vehicles shall be allowed within the Pink Hatched Blue Area.
- (j) The said Lessee shall at all reasonable times prior to the surrender of the whole of the Pink Hatched Blue Area to the Government in accordance with sub-clause (g) of this Clause permit the Director, his officers, contractors and any other persons authorized by him with or without tools, equipment, machinery or motor vehicles, the right of ingress, egress and regress to, from and through the premises hereby expressed to be demised or any part thereof for the purpose of inspecting, checking and supervising any works to be carried out in compliance with sub-clause (b) of this Clause and the carrying out, inspecting, checking and supervising of any works which the Director may consider necessary in the Pink Hatched Blue Area. The Director, his officers, contractors and any other persons authorized by him shall have no liability in respect of any loss, damage, nuisance or disturbance whatsoever caused to or suffered by the said Lessee or any other person whether arising out of or incidental to the exercise by the Director, his officers, contractors and any other persons authorized by him of the rights conferred under this sub-clause, and no claim for compensation or otherwise shall be made against the Government, the Director, his officers, contractors and any other persons authorized by him by the said Lessee in respect of any such loss, damage, nuisance or disturbance.
- (k) The Director shall have no liability in respect of any loss, damage, nuisance or disturbance whatsoever caused to or suffered by the said Lessee or any other person whether arising out of or incidental to the fulfilment of the said Lessee's obligations under this Clause, and no claim for compensation or otherwise shall be made against the Government or the Director or his authorized officers by the said Lessee in respect of any such loss, damage, nuisance or disturbance.

(Note: pursuant to Clause No.(26)(f), the Pink Hatched Blue Area has been carved out from the Lot under the Deed Poll registered in the Land Registry by Memorial No.12020702210014. It does not form part of the Lot on which the Development is situated, and will be maintained by the Vendor prior to their surrender to the Government.)

- (2) Provisions of the Deed of Mutual Covenant
Not applicable.

- (3) The general public has the right to use those facilities or open spaces (if any) mentioned above in accordance with the Land Grant.

4. The public sewers as referred to in Clause No.(36)(a) of the Second Schedule to the 2nd Modification Letter:

- (1) Provisions of the Land Grant

Clause No.(36)(a) of the Second Schedule to the 2nd Modification Letter stipulates that:-

- (a) The said Lessee shall at his own cost and expense and in all respects to the satisfaction of the Director repair and maintain the existing public sewer within the premises as indicated by the line marked "C D" on the plan annexed to the Lease (hereinafter referred to as "**the Existing Public Sewer**") and shall not divert it without the prior written consent of the Director. In the event such a consent is given the said Lessee in addition to complying with all requirements the Director may impose therefor shall at his own expense register in the Land Registry against the premises a record plan accepted by the Director indicating the alignment and dimensions of the public sewer within the premises after diversion (hereinafter referred to as "**the Diverted Public Sewer**") and shall thereafter at his own cost and expense repair and maintain the Diverted Public Sewer instead in all respects to the satisfaction of the Director and shall not divert the Diverted Public Sewer without the prior approval of the Director. For the avoidance of doubt the same obligations as above shall attach to any replacement of the Diverted Public Sewer.
- (b) If the said Lessee fails to repair and maintain the Existing Public Sewer or the Diverted Public Sewer in accordance with sub-clause (a) of this Clause, the Government may carry out the necessary repair and maintenance works at the cost of the said Lessee. The said Lessee shall pay to the Government on demand a sum equal to the cost thereof, such sum which shall include supervisory and overhead charges, to be determined by the Government whose determination shall be final and shall be binding upon the said Lessee.
- (c) The said Lessee shall allow ingress, egress, and regress for the Director and his duly authorized officers, contractors, his or their workmen with or without tools, equipment or machinery, to, from and through the premises at all reasonable time for the purpose of inspecting the Existing Public Sewer or the Diverted Public Sewer until diversion or replacement and carrying out the works referred to in sub-clause (b) of this Clause. The Government shall not be liable for any loss, damage, nuisance or disturbance including damage of any installation arising from the above works and from its exercise of power under this sub-clause.

- (2) Provisions of the Deed of Mutual Covenant

Clause 1.1 stipulates that:-

In this Deed the following words and expressions shall have the following meanings ascribed to them whenever the context so permits:-

...

"The Diverted Public Sewer"

The length of the sewer situate within the Land diverted with the prior written consent of the Director of Lands in accordance with the 2nd Modification Letter.

...

“Sewer”

The length of the existing public sewer situate within the Land and indicated by the line marked “C D” on the plan annexed to the Government Lease dated 14th April 1965 in respect of Rural Building Lot No.836.

Clause 5.1.54 stipulates that:-

The Owners shall at their own expense manage repair and maintain the Sewer, and in the event such Sewer is diverted with the prior written consent of the Director of Lands in accordance with the 2nd Modification Letter, the Diverted Public Sewer instead, to the satisfaction of the Director of Lands and shall at the Owners’ expense register in the Land Registry against the Land a record plan accepted by the Director of Lands indicating the alignment and dimensions of the Diverted Public Sewer.

Clause 6.2.1 stipulates that:-

...Without in any way limiting the generality of the foregoing the Manager shall have the following duties :-

...

(14)To prevent so far as is possible any refuse or other matter being deposited, washed, eroded or falling from the Estate into any part of the public highway, sewers, drains, nullahs or other Government property and to remove any such matter therefrom and to ensure that no damage is done to any drains, waterways, watercourses, footpaths, sewers, nullahs, pipes, cables, wires, utility services or other works being in, under, over or adjacent to the Land or any part or parts thereof by reason of any maintenance or other works carried out by the Manager as herein provided and to make good any such damage.

...

(3) The general public has the right to use those facilities or open spaces (if any) mentioned above in accordance with the Land Grant.

B. FACILITIES THAT ARE REQUIRED UNDER THE LAND GRANT TO BE MANAGED, OPERATED OR MAINTAINED FOR PUBLIC USE AT THE EXPENSE OF THE OWNERS OF THE RESIDENTIAL PROPERTIES IN THE DEVELOPMENT

1. Please refer to paragraph A above (except item 3).
2. The facilities or open spaces (if any) mentioned in paragraph A above (except item 3) are required to be managed, operated or maintained at the expense of the owners of the residential properties in the Development, and those owners are required to meet a proportion of the expense of the managing, operating or maintaining those facilities or open spaces (if any) through the management expenses apportioned to the residential properties concerned.

C. OPEN SPACE THAT IS REQUIRED UNDER THE LAND GRANT TO BE MANAGED, OPERATED OR MAINTAINED FOR PUBLIC USE AT THE EXPENSE OF THE OWNERS OF THE RESIDENTIAL PROPERTIES IN THE DEVELOPMENT

Not applicable.

D. ANY PART OF THE LAND (ON WHICH THE DEVELOPMENT IS SITUATED) THAT IS DEDICATED TO THE PUBLIC FOR THE PURPOSES OF REGULATION 22(1) OF THE BUILDING (PLANNING) REGULATIONS (CAP 123 SUB. LEG. F)

Not applicable.

Notes:

1. The term “premises hereby expressed to be demised” means “the Lot” as referred to in the “Summary of Land Grant” section, unless otherwise specified.
2. The term “Director” means “the Director of Lands”, unless otherwise specified.
3. The term “said Lessee” means “the Grantee” as referred to in the “Summary of Land Grant” section, unless otherwise specified.

A. 根據批地文件規定須興建並提供予政府或供公眾使用的設施

1. 第一份修訂書附表2第(6)至(11)條所指之「綠色範圍」

(1) 批地文件條文

第一份修訂書附表2第(6)條規定：-

- (a) 批出地段連同一項權利批授該承授人及其租客、傭僕、訪客、工人及其他獲其就此授權人士於本文所協定的批地年期內不時及時刻均有權在署長批准的高度通行及再通行、往來及穿越鄉郊地段第299至306號於該附圖以黃色顯示的範圍（以下稱為「黃色範圍」）及政府土地於本文隨附「圖則A」上以綠色顯示的範圍（以下稱為「綠色範圍」），以作所有關乎正當使用及享用批出地段的用途。
- (b) 該承授人須自費按署長要求或認可的方式、物料及標準，於本條款(a)分條所述有通行權通過及經過綠色範圍上興建一條鋪平道路及相關的街道設施、交通輔助設施、街道照明、污水渠、排水渠及其他構築物。
- (c) 該承授人須自費維持、保養及維修綠色範圍及全部形成該範圍的一部分或相關部分，並達致署長全面滿意，而該承授人須如同綠色範圍的全權擁有人負責整個綠色範圍。
- (d) 若任何公眾道路改建後涵蓋綠色範圍的一部份（其就此已授予通行權）或影響其坡度，該承授人不得就此提出任何申索，並須自費對所鋪設道路進行所有相應的改建工程，以達致署長滿意。
- (e) 本條款(a)分條所述給予的通行權並非授予承授人享用綠色範圍的專用權，而政府有權於現在或將來授予其他鄰近地段的業主通越綠色範圍的通行權，或收回全部或部份綠色範圍以作為公共街道而不須向該承授人或任何獲授予綠色範圍所有或任何部份通行權的其他業主作出任何賠償。
- (f) 若該承授人不履行本條款(b)及(c)分條訂明之責任，政府可進行所需之建造、保養及維修工程，惟費用由該承授人支付，就此該承授人須應政府要求向政府繳付一筆數額等於上述工程費用之款項，該數額由署長釐定，此決定為最終決定並對該承授人具約束力。
- (g) 儘管授予本條款(a)分條所指的通行權，政府仍有全權及權力向該承授人發出不少於十四天事前書面通知（緊急情況除外）後，按署長絕對酌情為恰當，鋪設、安裝、重鋪、改道分流、拆除、重置、更換、檢查、運作、修理、保養及更新現時或此後任何時間位於綠色範圍上、下或毗鄰該處的任何政府或其他排水渠、下水道、水路或水道、污水渠、明渠、總水管、管道、電纜、電線、管線、公用服務設施或其他工程或裝置（以下統稱「該等綠色範圍服務」），並妥善修葺任何損毀。署長、其官員、承辦商及任何其他獲其授權人士及彼等之工人時刻均有權自由進出及再進出和行經綠色範圍，不論是否攜同工具、設備、機器或車輛，以作上述用途。除非事前獲得署長書面同意，該承授人不可干擾或允許他人干擾該等綠色範圍服務。除修復任何及所有因其行使上述權利及權力導致的損毀外，就任何對該承授人所造成或蒙受的損失、破壞、滋擾或干擾，不論是因行使本分條的權利而起的或隨之而來的，政府、署長、其官員、承辦商及任何其他獲其授權人士、其或彼等之工人概不承擔任何責任，且該承授人不得針對他或他們提出任何申索或反對。

第一份修訂書附表2第(11)條規定：-

該承授人須在任何時候，特別是在進行建造、保養、翻新、維修工程（「該等工程」）期間，採取或促使他人

採取一切適當及充分的謹慎、技巧及預防措施，以避免對任何政府擁有或其他現存排水渠、水路或水道、總水管、道路、行人路、街道設施、污水渠、明渠、管道、電纜、電線、公用服務設施或任何其他於批出地段、綠色範圍、綠色加黑點範圍、或該等土地之任何組合或任何部分上面、之上、之下或毗鄰進行的工程或運作的裝置（以下統稱「該等服務」）造成任何損壞、干擾或阻塞。該承授人須於進行任何該等工程前進行或促使他人進行有需要的適當勘探及查究，以確定該等服務的現況及程度，並就如何處理任何可受該等工程影響的該等服務向署長提交書面建議供其在所有方面批准，且於署長書面同意該等工程及上述建議前不得進行任何工程。該承授人須遵守及自費履行署長於給予上述批准時就該等服務施加的任何要求，包括任何有需要的改道、重鋪或修復費用。該承授人須自費在各方面維修、彌補及修復因該等工程而對批出地段、綠色範圍、綠色加黑點範圍、或該等土地之任何組合或任何部分、或任何該等服務（明渠、污水渠、雨水渠或總水管除外，其修復工程須由署長進行（除非署長另有決定），而該承授人須應要求向政府支付該等修復工程之費用）造成之任何損壞、干擾或阻塞，達致署長滿意。若該承授人未能對批出地段、綠色範圍、綠色加黑點範圍、或該等土地之任何組合或任何部分、或任何該等服務進行任何所需的改道、重鋪、維修、彌補及修復工程達致署長滿意，署長可進行他認為有需要的任何該等改道、重鋪、維修、修復或彌補工程，且該承授人須應要求向政府支付該等上述工程的費用。

(2) 公契文件條文

第1.1條規定：-

在本公契中，在上下文義允許之下，下列詞語具有以下界定的意義：-

...

「綠色範圍」

第一份修訂書隨附「圖則A」上以綠色顯示的範圍，須按第一份修訂書附表2第(6)條進行維持、保養及維修。

...

「公眾公用地方及設施」

綠色範圍、綠色加黑點範圍（直至其佔管權交還予政府）。

第3.1.1條規定：-

獨立屋業主可享有下列的地役權、權利及特權之利益，但受限於本契約之條款，包括本文訂明管理人及第一業主享有之權利：

- (a) 獨立屋業主、其租客、傭僕、代理及受許可人均有全權及自由（與其他享有同等權利之人士共享，但受限於公眾關乎於公眾公用地方及設施之權利）通行及再通行、往來和使用屋苑公用地方及屋苑公用設施，以作關乎正常使用及享用獨立屋。

第6.2.1條規定：-

... 在任何方面不限制上述一般適用範圍下，管理人有下列職責：-

...

- (14) 盡量防止屋苑的任何垃圾或其他物件被置於、沖往、腐爛或墮進任何公共道路、污水渠、排水渠、明渠或其他政府產業及移除任何上述物件，以及確保該土地或任何部份內、以下、以上或其鄰近之排水渠、水道、水路、行人路、污水渠、明渠、管道、電纜、電線、公用服務或其他工程不因管理人根據本文訂明進行的任何保養或其他工程而受任何損害，並恢復任何上述損害。

...

(58) 根據及受限於政府租契之條款保養、維修、修葺使之恢復原狀公眾公用地方及設施。

第6.4.1條規定：-

屋苑業主須每月以下述方式預先繳付予管理人管理支出，當中包括下列項目：-

...

(w) 維持、維修及修葺使之恢復原狀綠色範圍及綠色加黑點範圍之開支。

(3) 公眾有權按照批地文件使用上文提及的設施或休憩用地（如有）。

2. 第一份修訂書附表4第(21)至(24)條所指之「綠色加黑點範圍」

(1) 批地文件條文

第一份修訂書附表4第(21)(a)條規定：-

(a) 該承授人必須：

(i) 在屋宇署為拆卸批出地段上於2010年8月27日存在的建築物而發出的第一份同意書（以下稱為「**第一份同意書**」）的日期起60個曆月內（或經署長批准之延期），自費以署長批准的方式及物料、標準、高度、定線和設計進行下列工程，以全面令署長滿意：

(I) 鋪設及興建在本文件隨附「圖則A」上以綠色加黑點顯示的範圍（以下稱為「**綠色加黑點範圍**」）的未來公共道路部份；及

(II) 提供及興建指定天橋、隧道、高架道路、地下通道、溝渠、高架橋、行車天橋、行人路、道路或署長運用絕對酌情權下規定的其他構築物（以下統稱為「**構築物**」）

致使建築、車輛及行人交通將可於綠色加黑點範圍進行。

(ii) 在第一份同意書的日期起60個曆月內（或經署長批准之延期），在署長滿意之情況下自費在綠色加黑點範圍鋪設表面、建造路緣及渠道，並提供署長規定的溝渠、污水渠、排水渠、消防栓連同接駁至總喉的喉管、街燈、交通標誌、街道設施及道路標記；及

(iii) 自費保養綠色加黑點範圍連同該等構築物以及所有建造、安裝及提供在其上或內的構築物、路面、溝渠、污水渠、排水渠、消防栓、服務、街燈、交通標誌、街道設施、道路標記及植物，達致署長滿意，直至綠色加黑點範圍之管有權根據條款第(22)條交還為止。

(b) 若該承授人不在指定時間內履行本條款(a)分條之責任，政府可進行所需之工程，惟費用由該承授人支付，就此該承授人須應政府要求向政府繳付一筆數額等於上述工程費用之款項，該數額由署長釐定，此決定為最終決定並對該承授人具約束力。

(c) 就任何對該承授人或任何其他人士造成或蒙受的任何損失、破壞、滋擾或干擾，不論是因該承授人履行本條款(a)分條的責任或政府行使本條款(b)分條的權利或其他原因而起的或隨之而來的，署長概不承擔任何責任；該承授人亦不得向政府、署長或其獲授權官員就該等損失、破壞、滋擾或干擾就賠償提出任何申索。

第一份修訂書附表4第(22)條規定：-

僅為了進行條款第(21)條指定的必要工程，該承授人於本第一份同意書簽立之日獲授予綠色加黑點範圍的管有權。該承授人須應政府要求交還綠色加黑點範圍，但無論如何，若署長致函發出信件表示本文件各項條件已妥為履行達致其滿意，綠色加黑點範圍即被視為已於發信當天由該承授人交回政府。該承授人須在其管有綠色加黑點範圍的所有合理時間內容許所有政府及公眾車輛及行人自由通過及經過綠色加黑點範圍，並確保其通行不受條款第(21)條或其他條款所進行的工程的干擾或阻礙。

第一份修訂書附表4第(23)條規定：-

未經署長事先書面同意，該承授人不得使用綠色加黑點範圍作儲存或架設任何臨時構築物，又或進行條款第(21)條所指定之工程以外的其他用途。

第一份修訂書附表4第(24)條規定：-

(a) 該承授人須在其管有綠色加黑點範圍期間的所有合理時間內：

(i) 允許署長、其官員、承辦商及任何其他獲其授權人士進出及再進出和行經及通過批出地段及綠色加黑點範圍，以便檢查、查核及監督任何遵照條款第(21)(a)條規定進行的工程及執行、檢查、查核及監督任何遵照條款第(21)(b)條規定進行的工程，以及署長認為必須在綠色加黑點範圍進行的其他工程；

(ii) 允許政府及獲政府授權的相關公共事業公司應其要求進出及再進出和行經及通過批出地段及綠色加黑點範圍，以供其在綠色加黑點範圍或任何毗連土地之內、之上或之下進行任何工程，包括但不限於鋪設及於其後保養所有管道、電線、導管、電纜管道及其他傳導媒體及為向批出地段或任何毗連或鄰近土地或處所提供電訊、電力、氣體（如有）及其他服務而所需的附屬設備。該承授人須就有關任何上述於綠色加黑點範圍內進行之工程之所有事宜與政府及政府妥為授權的有關公共事業公司通力合作；及

(iii) 允許水務監督之官員或其他獲其授權之人士應其要求有權進出及再進出和行經及通過批出地段及綠色加黑點範圍，以進行任何與裝設於綠色加黑點範圍內之水務設施之操作、保養、維修、更換及改動有關的工程。

(b) 就任何對該承授人或任何其他人士造成或蒙受的損失、破壞、滋擾或干擾，不論是因政府、其官員、代理人、承辦商及任何其他妥為授權人士或公用事業公司行使本條款(a)分條之權利而起的或隨之而來的，政府概不承擔任何責任。

(2) 公契文件條文

第1.1條規定：-

在本公契中，在上下文義允許之下，下列詞語具有以下界定的意義：-

...

「綠色加黑點範圍」

第一份修訂書隨附「圖則A」上以綠色加黑點顯示的範圍之未來公共道路部份，須按第一份修訂書附表4第(21)(a)(i)(I)條鋪設及興建。

「公眾公用地方及設施」

綠色範圍、綠色加黑點範圍（直至其佔管權交還予政府）及屋苑公用地方及屋苑公用設施內根據政府租契或本文件之條款及條件開放予公眾使用之部份。

第6.2.1條規定：-

… 在任何方面不限制上述一般適用範圍下，管理人有下列職責：-

…

(14) 盡量防止屋苑的任何垃圾或其他物件被置於、沖往、腐爛或墮進任何公共道路、污水渠、排水渠、明渠或其他政府產業及移除任何上述物件，以及確保該土地或任何部份內、以下、以上或其鄰近之排水渠、水道、水路、行人路、污水渠、明渠、管道、電纜、電線、公用服務或其他工程不因管理人根據本文訂明進行的任何保養或其他工程受任何損害，並恢復任何上述損害。

…

(58) 根據及受限於政府租契之條款保養、維修、修葺使之恢復原狀公眾公用地方及設施。

第6.4.1條規定：-

屋苑業主須每月以下述方式預先繳付予管理人管理支出，當中包括下列項目：-

…

(w) 維持、維修及修葺使之恢復原狀綠色範圍及綠色加黑點範圍之開支。

(3) 公眾有權按照批地文件使用上文提及的設施或休憩用地（如有）。

3. 第一份修訂書附表4第(26)條所指之「粉紅色加藍色斜線範圍」

(1) 批地文件條文

第一份修訂書附表4第(26)條規定：-

(a) 除非事前獲得署長書面同意，不得在本文件隨附「圖則A」上以粉紅色加藍色斜線顯示的範圍（「粉紅色加藍色斜線範圍」）內興建或任何建築物或構築物或該建築物或構築物的支撐物。

(b) 該承授人須：

(i) 在第一份同意書的日期起60個曆月內（或經署長批准之延期），自費以署長批准的方式及物料、標準、高度、定線和設計進行下列工程，以全面令署長滿意：

(I) 鋪設及興建在粉紅色加藍色斜線範圍的未來公共道路部份；及

(II) 提供及興建指定天橋、隧道、高架道路、地下通道、溝渠、高架橋、行車天橋、行人路、道路或署長運用絕對酌情權下規定的其他構築物；

致使建築、車輛及行人交通將可於粉紅色加藍色斜線範圍進行。

(ii) 在第一份同意書的日期起60個曆月內（或經署長批准之延期），在署長滿意之情況下自費在粉紅色加藍色斜線範圍鋪設表面、建造路緣及渠道，並提供署長規定的溝渠、污水渠、排水渠、消防栓連同接駁至總喉的喉管、街燈、交通標誌、街道設施及道路標誌；及

(iii) 在完成本條款(b)(i)及(b)(ii)分條提及的工程後，根據本條款(f)及(g)分條將粉紅色加藍色斜線範圍交還予政府。

(c) 若該承授人不在指定時間內履行本條款(b)(i)及(b)

(ii)分條之責任，政府可進行所需之工程，惟費用由該承授人支付，就此該承授人須應政府要求向政府繳付一筆數額等於上述工程費用之款項，該數額由署長釐定，此決定為最終決定並對該承授人具約束力。

(d) 就任何對該承授人或任何其他人所造成或蒙受的損失、破壞、滋擾或干擾，不論是因該承授人履行本條款(b)分條的責任或政府行使本條款(c)分條的權利或其他原因而起的或隨之而來的，政府概不承擔任何責任；該承授人亦不得向政府、署長或其獲授權官員就該等損失、破壞、滋擾或干擾提出任何申索。

(e) 該承授人須在根據本條款(g)分條將整個粉紅色加藍色斜線範圍交還予政府前並在完成本條款(b)(i)及(b)(ii)分條提及的工程後，允許政府和公眾在所有時間免費進出，自由地步行或乘坐輪椅通行及再通行、往來及穿越粉紅色加藍色斜線範圍，以作任何合法用途。

…

(g) 該承授人須在署長提出要求時自費向政府交還署長所指定的粉紅色加藍色斜線範圍或其任何部分（連同其空置管有權），且其不受產權負擔影響，其上並無任何構築物（除保留作道路擴闊用途之構築物或類似經署長批准的構築物外），而政府無需支付任何款項或賠償予該承授人。為了按上述交還粉紅色加藍色斜線範圍，該承授人須自費簽署一份土地交還契據及任何其他文件，其格式及所載條文須由署長批准或規定。該承授人無權就上述之土地交還而直接或間接引起或有關的損失、損害或補償向政府索償。

(h) 除建築按揭及根據本條款第(g)分條交回粉紅色加藍色斜線範圍外，該承授人不得將粉紅色加藍色斜線範圍或其任何部分或其內任何產權轉讓、抵押、押記、批租、轉租、放棄管有或以任何其他形式作出產權處置或設定產權負擔或簽訂任何協議作上述事宜。

(i) 該承授人不可將粉紅色加藍色斜線範圍或其任何部分用作任何除進行本條款(b)分條所述的工程以外的目的。粉紅色加藍色斜線範圍內不准停泊車輛。

(j) 該承授人須在其根據本條款(g)分條交回整個粉紅色加藍色斜線範圍予政府之前的所有合理時間內，允許署長、其官員、承辦商及任何其他獲其授權人士進出及再進出和行經及通過批出地段及其任何部分，不論是否攜同工具、設備、機器或車輛，以視察、檢查及監督根據本條款(b)分條須進行的任何工程，及進行、視察、檢查及監督署長認為有需要在粉紅色加藍色斜線範圍之內進行的任何其他工程。就任何對該承授人或任何其他人所造成或蒙受的損失、破壞、滋擾或干擾，不論是因署長、其官員、承辦商及任何其他獲其授權人士行使本分條的權利而起的或隨之而來的，署長、其官員、承辦商及任何其他獲其授權人士概不承擔任何責任；該承授人亦不得向政府、署長、其官員、承辦商及任何其他獲其授權人士就該等損失、破壞、滋擾或干擾提出任何賠償或其他申索。

(k) 就任何對該承授人或任何其他人所造成或蒙受的損失、破壞、滋擾或干擾，不論是因該承授人履行本條款的責任而起的或隨之而來的，署長概不承擔任何責任；該承授人亦不得針向政府、署長、其官員或獲其授權人士就該等損失、破壞、滋擾或干擾提出任何賠償或其他申索。

（備註：根據條款第(26)(f)條，粉紅色加藍色斜線範圍已按照於土地註冊處註冊的分割契據〈註冊編號

12020702210014) 從該地段分割出來。粉紅色加藍斜線範圍並不構成發展項目所位於的該地段的一部分，並且於交還予政府前將由賣方進行保養工作。)

(2) 公契文件條文

不適用。

(3) 公眾有權按照批地文件使用上文提及的設施或休憩用地(如有)。

4. 第二份修訂書附表2第(36)(a)條所指之「公眾污水渠」

(1) 批地文件條文

第二份修訂書附表2第(36)(a)條規定：-

(a) 該承授人需自費維修及保養批出地段的現有公眾污水渠，於租契隨附圖則上以「C D」線條顯示（「現有公眾污水渠」），並全面達致署長滿意，除獲署長事先書面同意外，該承授人不得進行該污水管的改道工程。倘若該承授人獲得上述同意及履行署長批出上述同意時就該等服務施加的所有要求後，自費到土地註冊處就批出地段登記獲署長批准的圖則，表明該公眾污水管道改道後的定線和尺寸（「經改道公眾污水渠」），並其後自費維修及保養經改道公眾污水渠以作替代，以全面令署長滿意，除獲署長事先同意外，該承授人不得進行經改道公眾污水渠的改道工程。為免生疑問，該承授人對任何替換經改道公眾污水渠負有的相同義務。

(b) 若該承授人未有根據本條款(a)分條維修及保養現有公眾污水渠或經改道公眾污水渠，政府可進行所需之維修及保養工程，惟費用由該承授人支付，就此該承授人須應政府要求向政府繳付一筆數額等於上述工程費用之款項，該數額由政府釐定，此決定為最終決定並對該承授人具約束力。

(c) 該承授人須在所有合理時間內允許署長及獲其妥為授權官員、承辦商或其工人進出及再進出和行經及通過批出地段，不論是否攜同工具、設備、機器，以視察現有公眾污水渠或經改道公眾污水渠直至被改道或替換及進行本條款(b)分條所指的工程。就任何因上述工程和政府行使本分條的權力而起的損失、破壞、滋擾或干擾（包括任何安裝的破壞），政府概不承擔任何責任。

(2) 公契文件條文

第1.1條規定：-

在本公契中，在上下文義允許之下，下列詞語具有以下界定的意義：-

...

「經改道公眾污水渠」

該土地內的污水渠根據第二份修訂書獲地政總署署長事先書面同意分流之長度。

...

「該污水渠」

該土地內的現有公眾污水渠，於有關鄉郊地段第836號餘段的政府租契（日期為1965年4月14日）隨附圖則上以「C D」線條顯示之長度。

第5.1.54條規定：-

業主須自費管理維修及維持該污水渠及在該污水渠根據第二份修訂書獲地政總署署長事先書面同意分流的情況下，則管理維修及維持經改道公眾污水渠，以達致地政總署署長滿意。業主亦須自費到土地註冊處就該土地登記獲署長接受的

記錄圖則，表明該公眾污水管道改道後的定線和尺寸。

第6.2.1條規定：-

... 在任何方面不限制上述一般適用範圍下，管理人有下列職責：-

...

(14) 盡量防止屋苑的任何垃圾或其他物件被置於、沖往、腐爛或墮進任何公共道路、污水渠管、排水渠、明渠或其他政府產業及移除任何上述物件，以及確保該土地或任何部份內、以下、以上或其鄰近之排水渠、水道、水路、行人路、污水渠、明渠、管道、電纜、電線、公用服務或其他工程不因管理人根據本文訂明進行的任何保養或其他工程受任何損害，並恢復任何上述損害。

...

(3) 公眾有權按照批地文件使用上文提及的設施或休憩用地(如有)。

B. 根據批地文件規定須由發展項目中的住宅物業的擁有人出資管理、營運或維持以供公眾使用的任何設施

1. 請參照以上第A段（除第3項外）。

2. 第A段（除第3項外）所提及之設施或休憩用地（如有）按規定須由發展項目中的住宅物業的擁有人出資管理、營運或維持。該等擁有人按規定須以由有關住宅物業分攤的管理開支，應付管理、營運或維持該等設施或休憩用地（如有）的部分開支。

C. 根據批地文件規定須由該項目中的住宅物業的擁有人出資管理、營運或維持以供公眾使用的任何休憩用地的大小

不適用。

D. 發展項目所位於的土地中為施行《建築物（規劃）規例》（第123章，附屬法例F）第22(1)條而撥供公眾用途的任何部分

不適用。

備註：

1. 除非另有指明，「批出地段」一詞所指的是批地文件的摘要內「該地段」一詞。

2. 除非另有指明，「署長」一詞所指的是「地政總署署長」。

3. 除非另有指明，「該承授人」一詞所指的是批地文件內「承授人」一詞。

Green Area, the Green Stippled Black Area and the Pink Hatched Blue Area
 綠色範圍、綠色加黑點範圍及粉紅色加藍色斜線範圍



 Pink Hatched Blue Area
 粉紅色加藍色斜線範圍

 Green Stippled Black Area
 綠色加黑點範圍

 Green Area
 綠色範圍



Scale: 0 20 40 60 80 100 Metres (米)
 比例: 

Notes:

1. This plan is a reproduction of Plan No.HKM8356 as annexed to the Land Grant.
2. This plan is for showing the locations of the Green Area, the Green Stippled Black Area and the Pink Hatched Blue Area only. Other matters shown in this plan may not reflect their latest conditions.

附註:

1. 此圖複製自附於批地文件的圖則編號HKM8356。
2. 此圖僅作顯示綠色範圍、綠色加黑點範圍及粉紅色加藍色斜線範圍的位置，圖中所示之其他事項未必能反映其最新狀況。

Existing Public Sewer 現有公眾污水渠

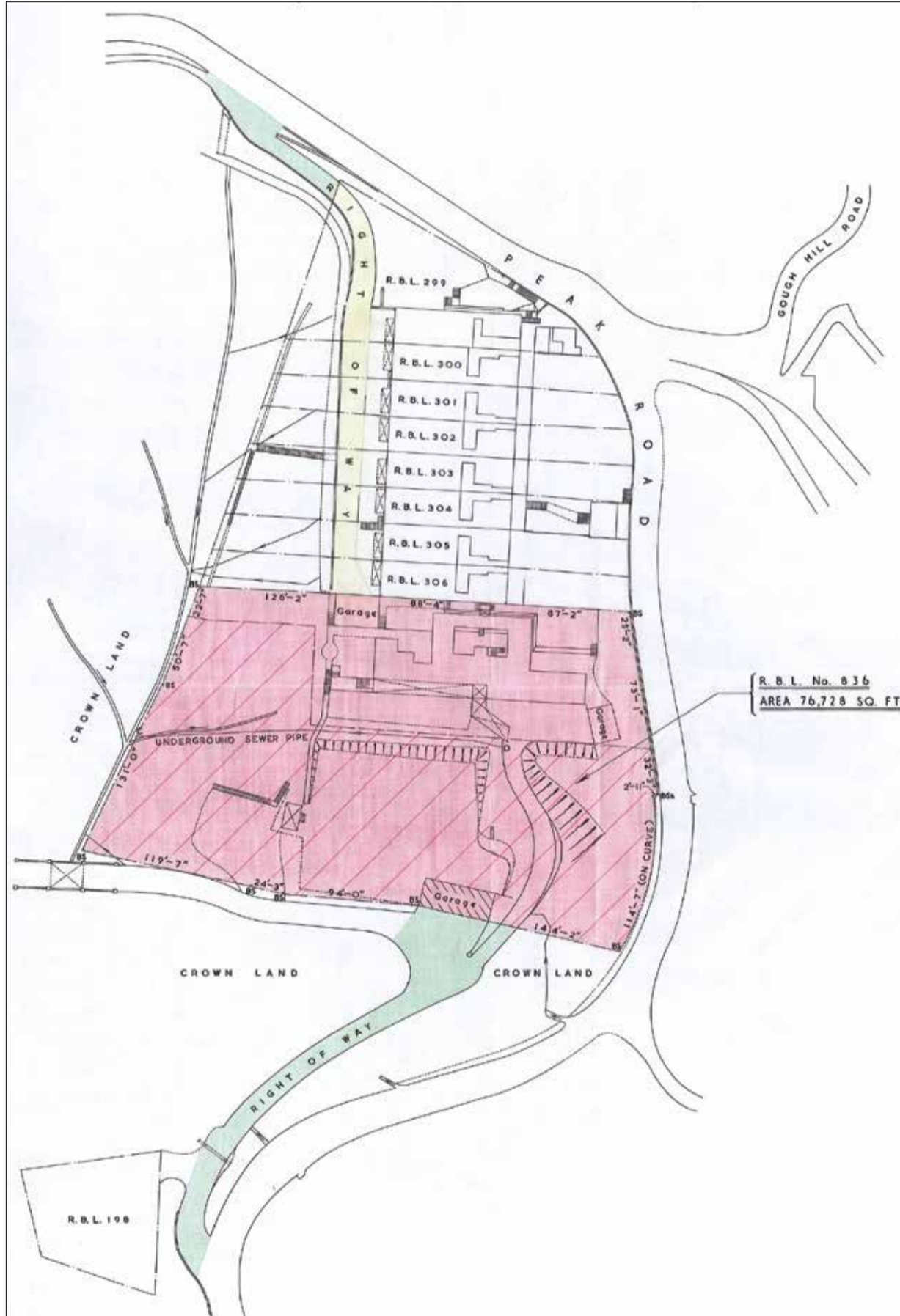

Notes:

1. This plan is a reproduction of plan annexed to the Government Lease of the Lot dated 14 April 1965.
2. This plan is for showing the location of Existing Public Sewer only. Other matters shown in this plan may not reflect their latest conditions.

附註:

1. 此圖複製自訂立於1965年4月14日的該地段的政府租契之隨附圖則。
2. 此圖僅作顯示現有公眾污水渠的位置，圖中所示之其他事項未必能反映其最新狀況。

Diverted Public Sewer
 經改道公眾污水渠

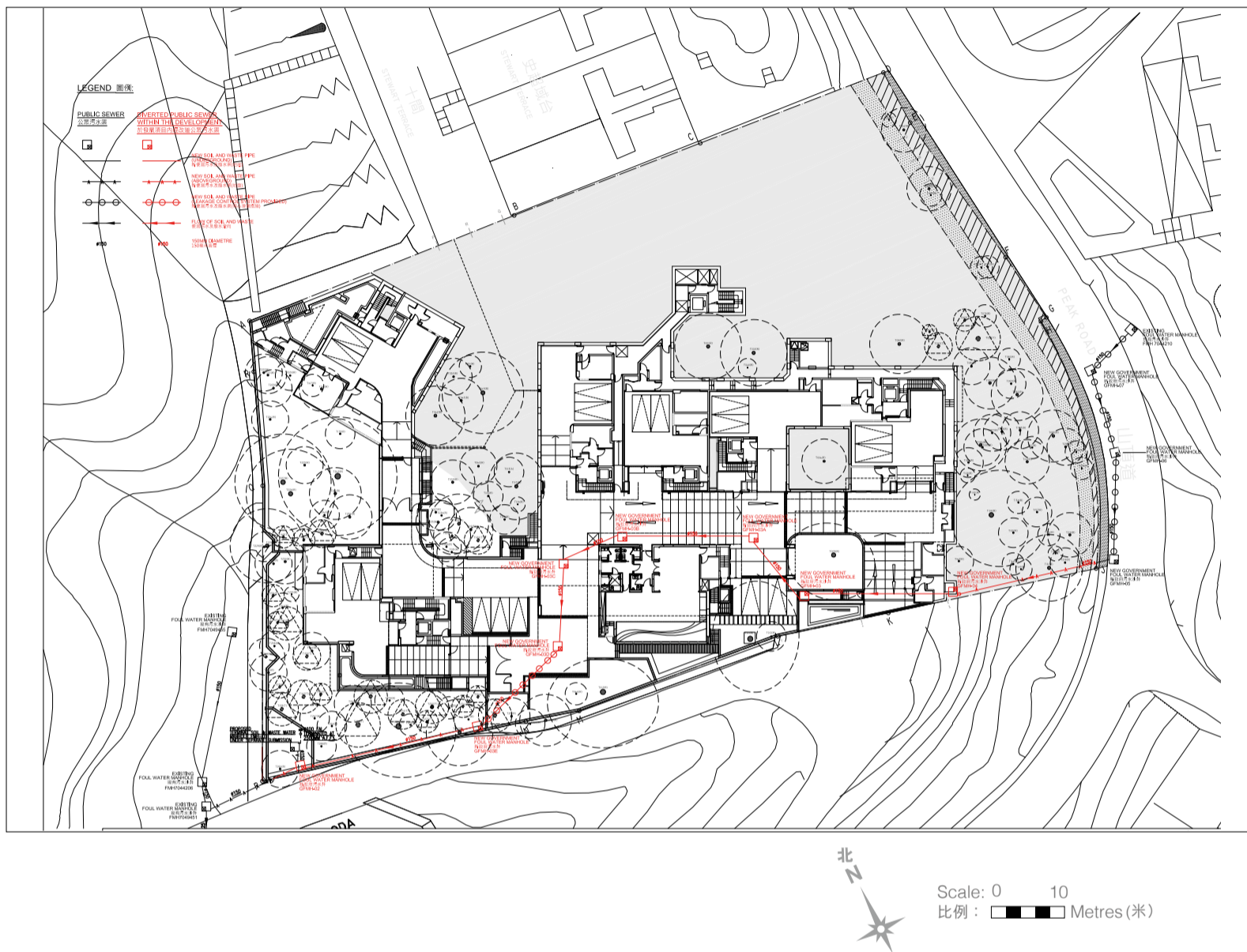

Notes:

1. This plan is a reproduction of Proposed Diverted of Public Sewer Layout Plan No.8533/DR/ADR201(A) Rev.B approved by the Building Authority and the Lands Department.
2. This plan is for showing the location of Diverted Public Sewer only. Other matters shown in this plan may not reflect their latest conditions.

附註：

1. 此圖複製自經建築事務監督及地政總署批核之擬建公眾污水渠位置圖(編號8533/DR/ADR201(A) Rev.B)。
2. 此圖僅作顯示經改道公眾污水渠的位置，圖中所示之其他事項未必能反映其最新狀況。

1. The purchaser is recommended to instruct a separate firm of solicitors (other than that acting for the Vendor) to act for the purchaser in relation to the transaction.
 2. If the purchaser instructs such separate firm of solicitors to act for the purchaser in relation to the transaction, that firm will be able to give independent advice to the purchaser.
 3. If the purchaser instructs the firm of solicitors acting for the Vendor to act for the purchaser as well, and a conflict of interest arises between the Vendor and the purchaser:
 - (i) that firm may not be able to protect the purchaser's interests; and
 - (ii) the purchaser may have to instruct a separate firm of solicitors.
 4. In the case of paragraph (3)(ii), the total solicitors' fees payable by the purchaser may be higher than the fees that would have been payable if the purchaser had instructed a separate firm of solicitors in the first place.
1. 現建議買方聘用一間獨立的律師事務所（代表賣方行事者除外），以在交易中代表買方行事。
 2. 如買方聘用上述的獨立的律師事務所，以在交易中代表買方行事，該律師事務所將會能夠向買方提供獨立意見。
 3. 如買方聘用代表賣方行事的律師事務所同時代表買方行事，而賣方與買方之間出現利益衝突：
 - (i) 該律師事務所可能不能夠保障買方的利益；及
 - (ii) 買方可能要聘用一間獨立的律師事務所。
 4. 如屬(3)(ii)段的情況，買方須支付的律師費用總數，可能高於如買方自一開始即聘用一間獨立的律師事務所便須支付的費用。

79 Peak Road 山頂道79號 Cross-section Plan 橫截面圖



79A Peak Road 山頂道79A號 Cross-section Plan 1 橫截面圖 1

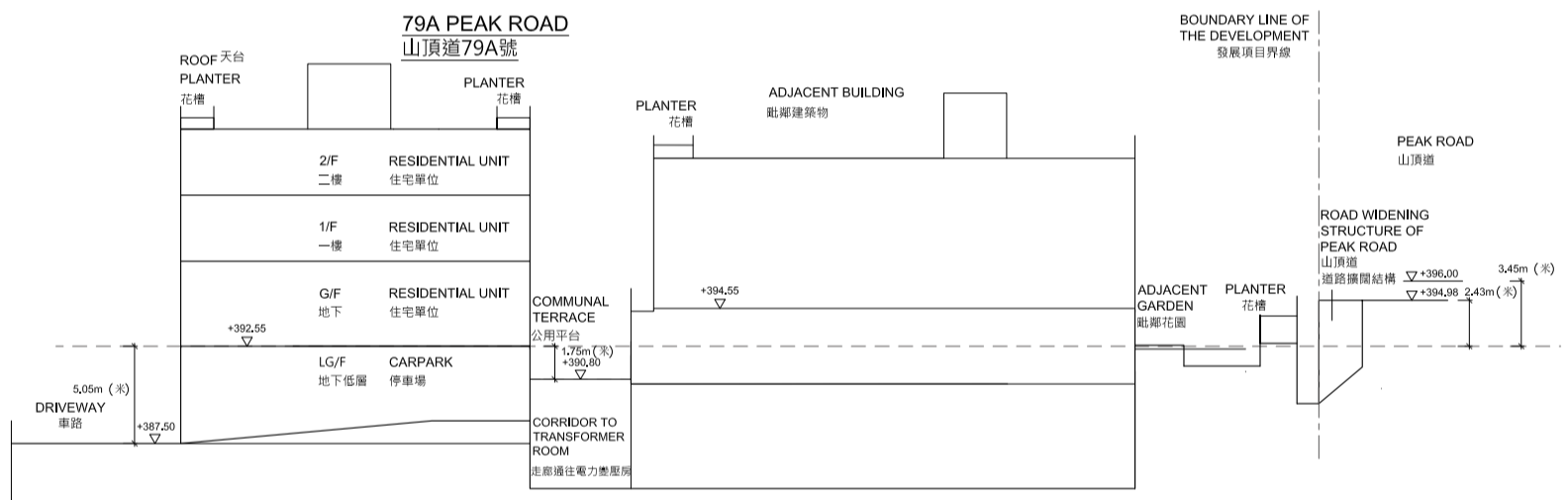

Key Plan
索引圖

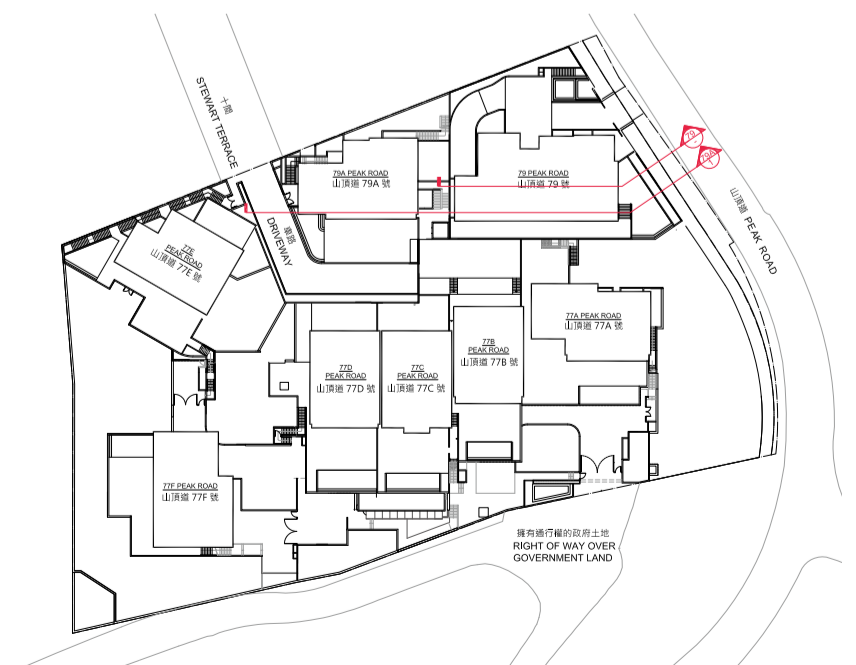

79A Peak Road 山頂道79A號 Cross-section Plan 2 橫截面圖2

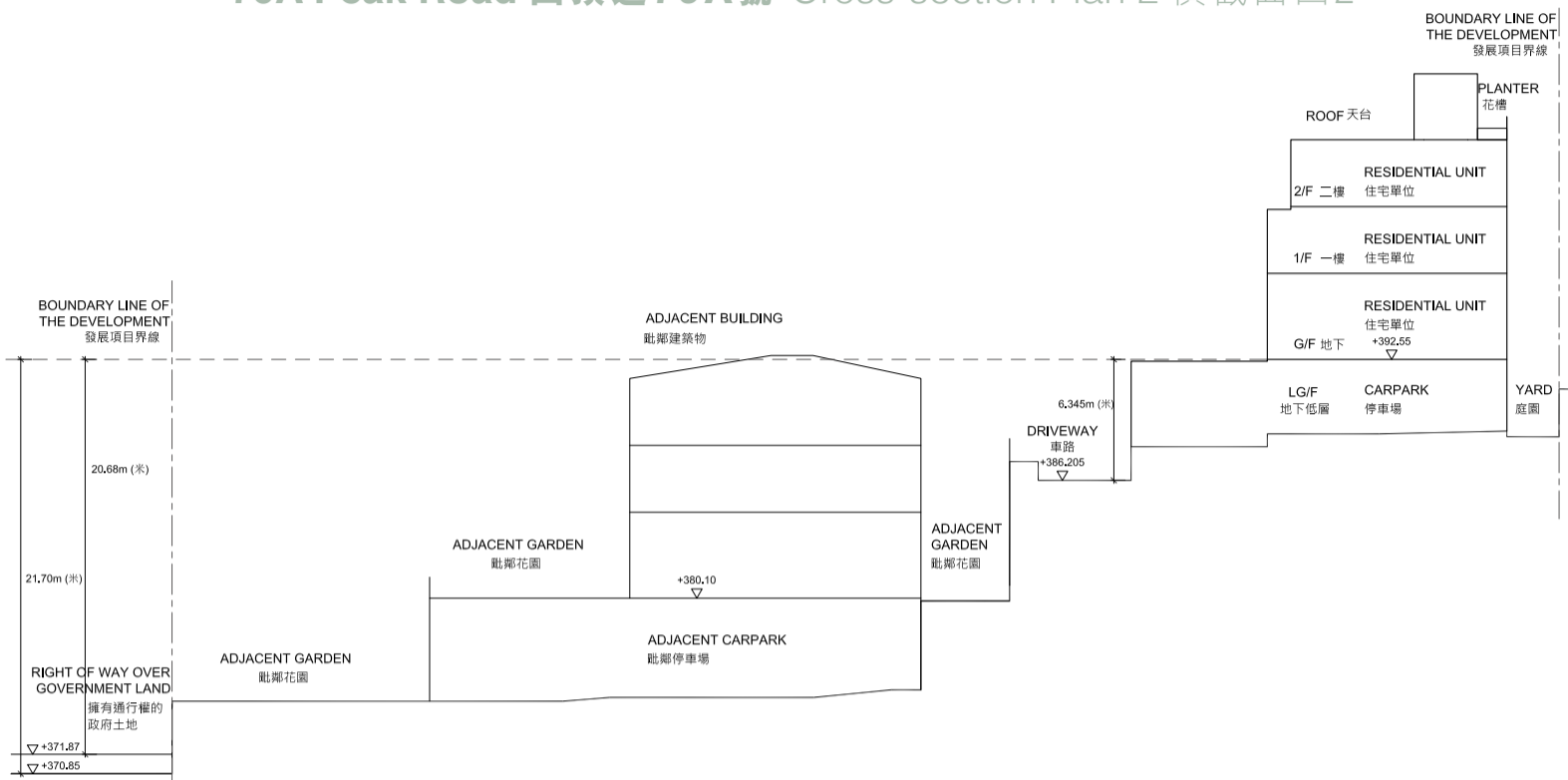

The part of Driveway adjacent to the building is 386.205 metres above the Hong Kong Principal Datum

The part of Right of Way over Government Land adjacent to the building is 370.85 to 371.87 metres above the Hong Kong Principal Datum

--- Dotted line denotes lowest residential floor
△ or ▽ donates height (in metres) above the Hong Kong Principal Datum

毗連建築物的一段車路為香港主水平基準以上386.205米

毗連建築物的一段擁有通行權的政府土地為香港主水平基準以上370.85至371.87米

--- 虛線為最底住宅樓層水平
△或▽代表香港水平基準以上的高度(米)

77A Peak Road 山頂道77A號 Cross-section Plan 橫截面圖

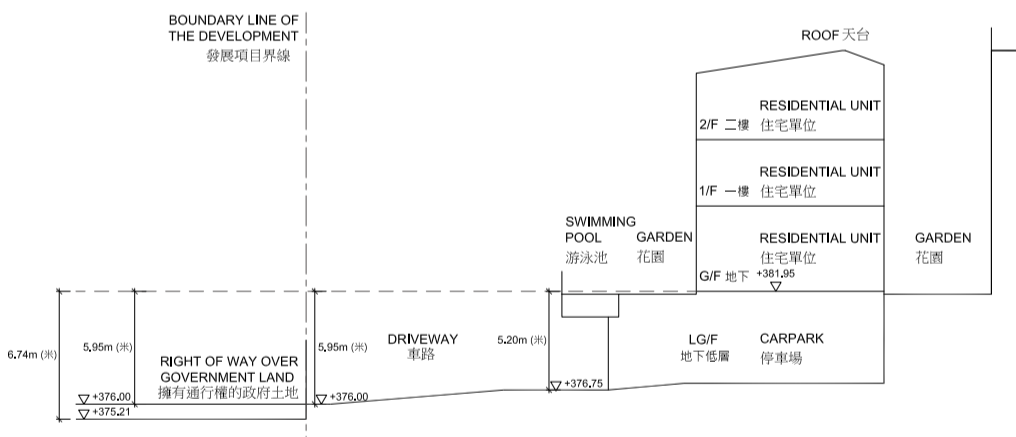

The part of Right of Way over Government Land adjacent to the building is 375.21 to 376.00 metres above the Hong Kong Principal Datum

The part of Driveway adjacent to the building is 376.00 to 376.75 metres above the Hong Kong Principal Datum

--- Dotted line denotes lowest residential floor
△ or ▽ donates height (in metres) above the Hong Kong Principal Datum

毗連建築物的一段擁有通行權的政府土地為香港主水平基準以上375.21至376.00米

毗連建築物的一段車路為香港主水平基準以上376.00至376.75米

--- 虛線為最底住宅樓層水平
△或▽代表香港水平基準以上的高度(米)

Key Plan
索引圖

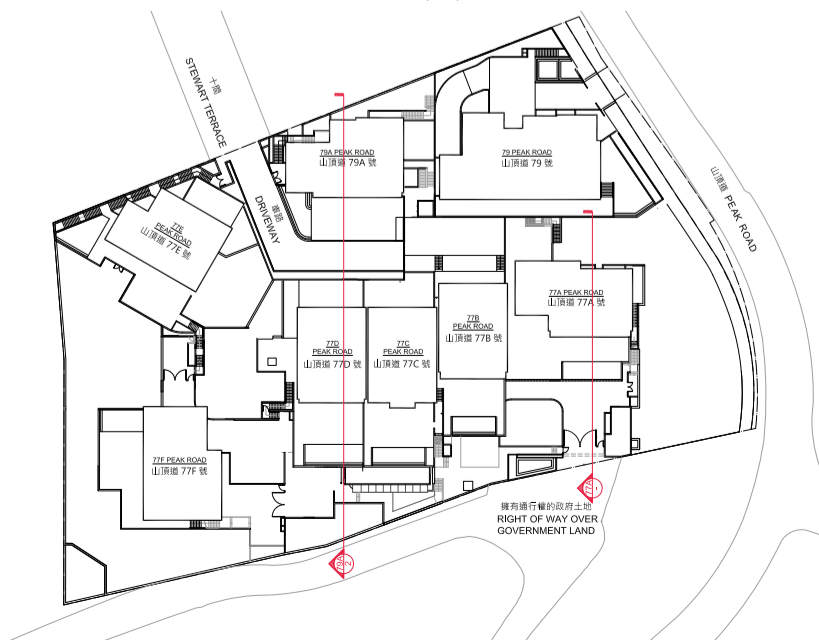

77B Peak Road 山頂道77B號 Cross-section Plan 橫截面圖

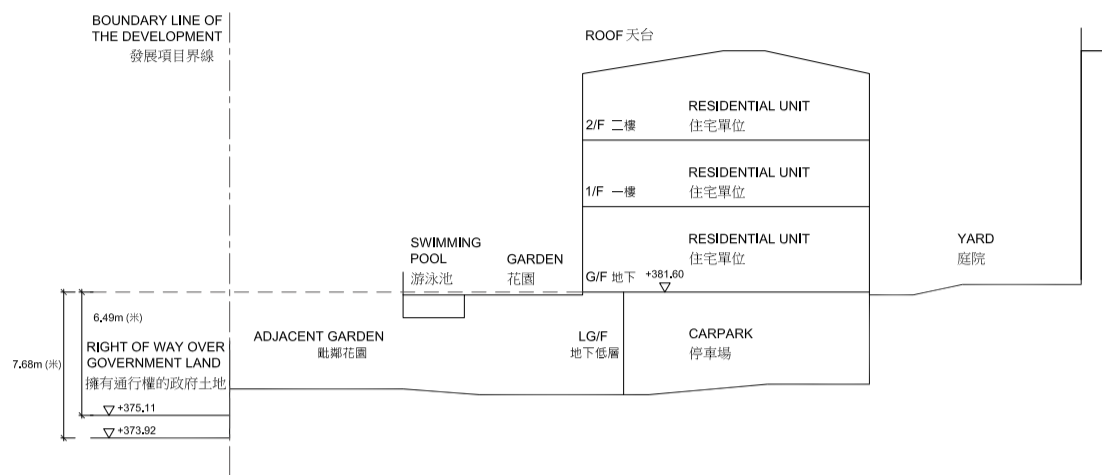

The part of Right of Way over Government Land adjacent to the building is 373.92 to 375.11 metres above the Hong Kong Principal Datum

毗連建築物的一段擁有通行權的政府土地為香港主水平基準以上 373.92至375.11米

- Dotted line denotes lowest residential floor
- △ or ▽ donates height (in metres) above the Hong Kong Principal Datum

- 虛線為最底住宅樓層水平
- △ 或 ▽ 代表香港水平基準以上的高度(米)

77C Peak Road 山頂道77C號 Cross-section Plan 橫截面圖

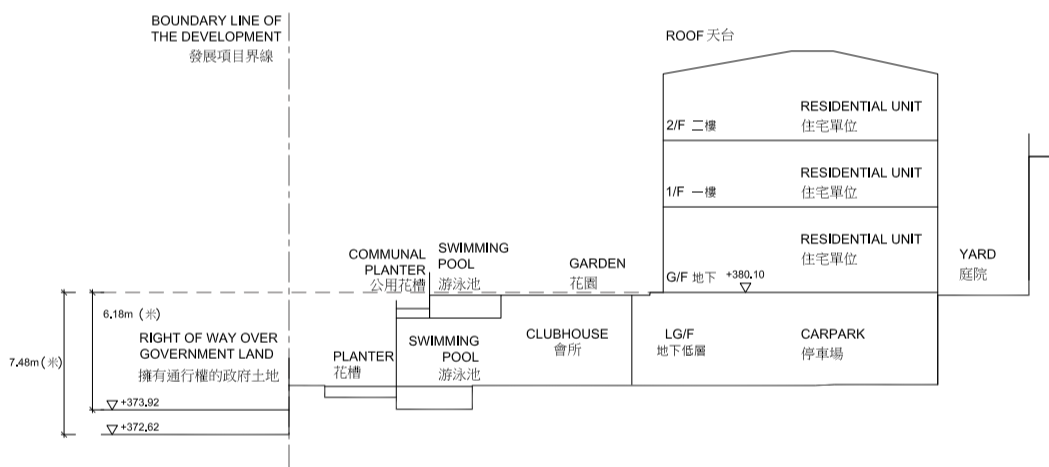

The part of Right of Way over Government Land adjacent to the building is 372.62 to 373.92 metres above the Hong Kong Principal Datum

毗連建築物的一段擁有通行權的政府土地為香港主水平基準以上 372.62至373.92米

- Dotted line denotes lowest residential floor
- △ or ▽ donates height (in metres) above the Hong Kong Principal Datum

- 虛線為最底住宅樓層水平
- △ 或 ▽ 代表香港水平基準以上的高度(米)

Key Plan
索引圖

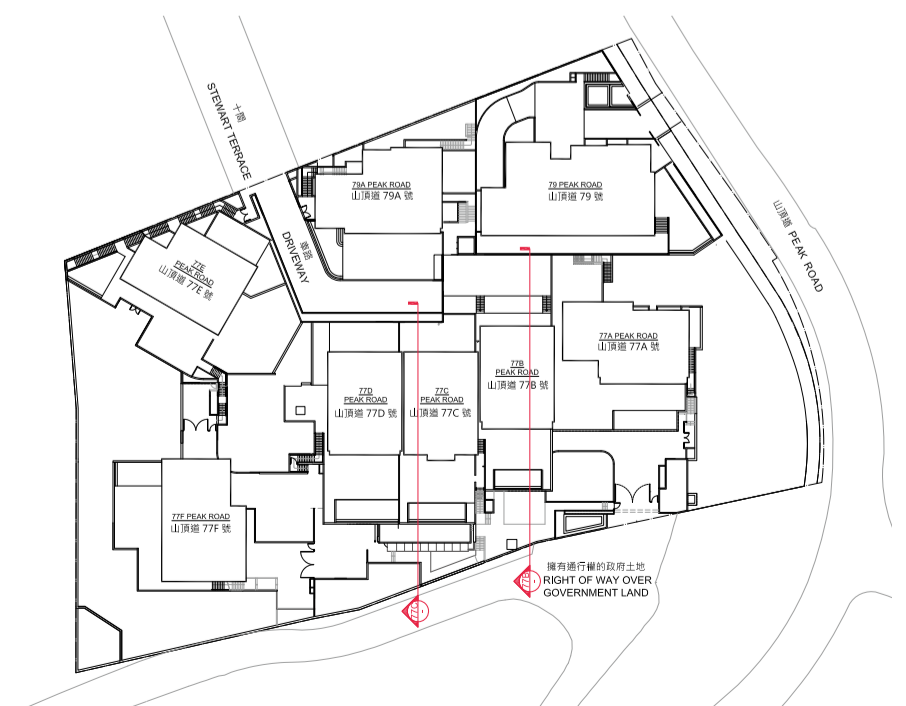

77D Peak Road 山頂道77D號 Cross-section Plan 橫截面圖

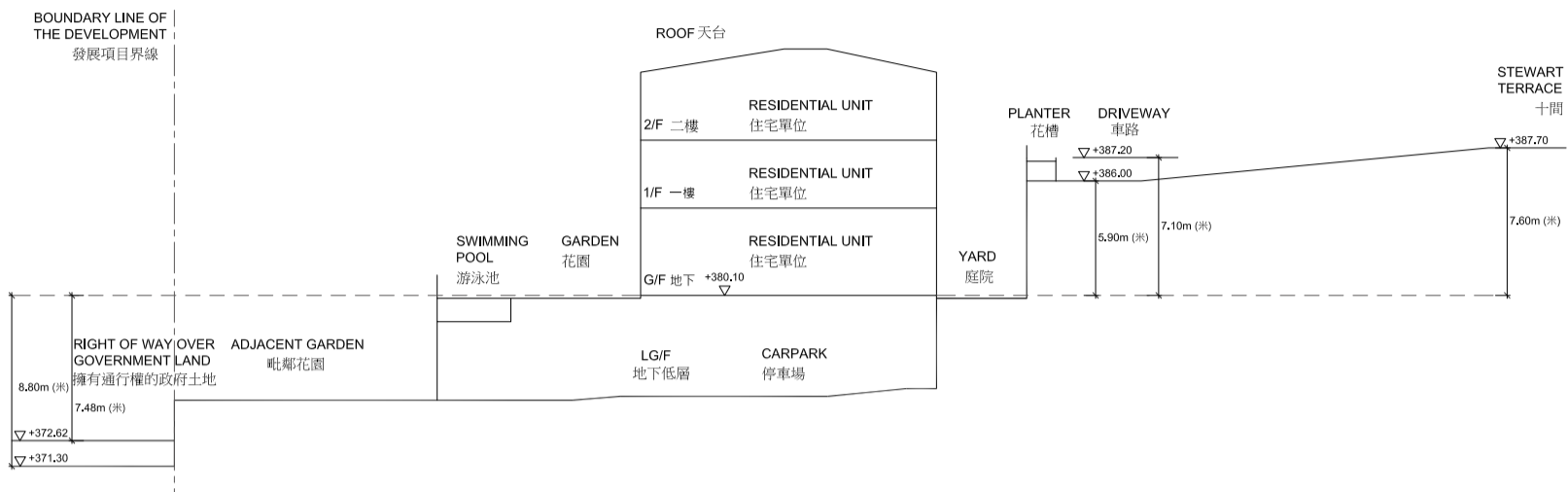

The part of Stewart Terrace adjacent to the building is 387.70 metres above the Hong Kong Principal Datum

The part of Driveway adjacent to the building is 386.00 to 387.20 metres above the Hong Kong Principal Datum

The part of Right of Way over Government Land adjacent to the building is 371.30 to 372.62 metres above the Hong Kong Principal Datum

--- Dotted line denotes lowest residential floor

△ or ▽ donates height (in metres) above the Hong Kong Principal Datum

毗連建築物的一段十間為香港主水平基準以上387.70米

毗連建築物的一段車路為香港主水平基準以上386.00至387.20米

毗連建築物的一段擁有通行權的政府土地為香港主水平基準以上371.30至372.62米

--- 虛線為最底住宅樓層水平

△ 或 ▽ 代表香港水平基準以上的高度(米)

77E Peak Road 山頂道77E號 Cross-section Plan 橫截面圖

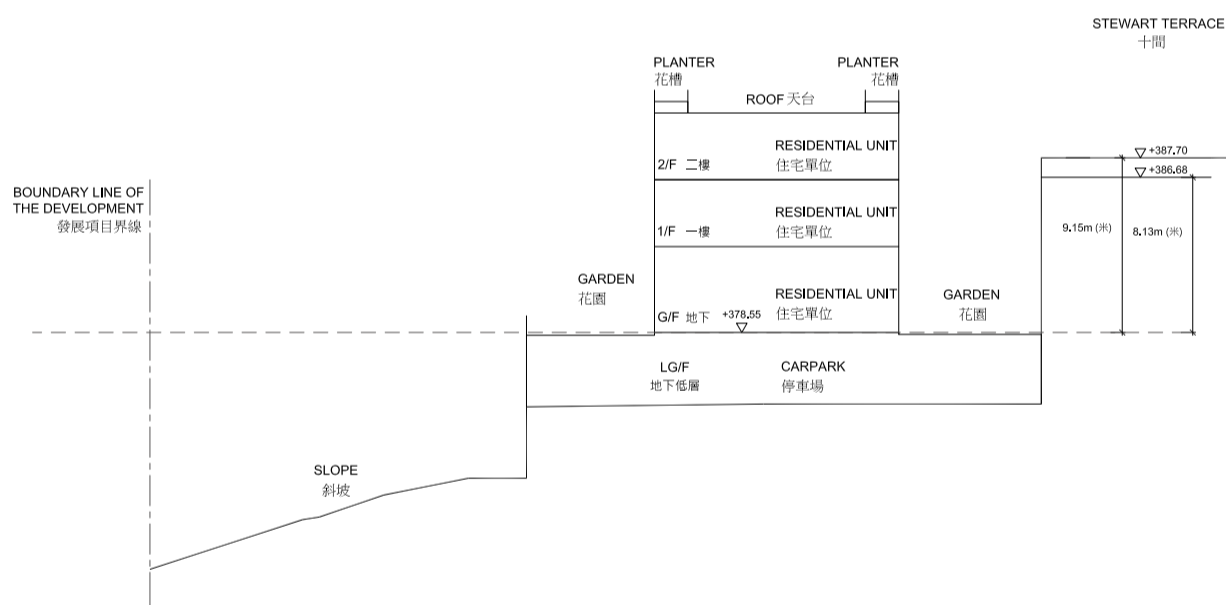

The part of Stewart Terrace adjacent to the building is 386.68 to 387.70 metres above the Hong Kong Principal Datum

--- Dotted line denotes lowest residential floor

△ or ▽ donates height (in metres) above the Hong Kong Principal Datum

毗連建築物的一段十間為香港主水平基準以上386.68至387.70米

--- 虛線為最底住宅樓層水平

△ 或 ▽ 代表香港水平基準以上的高度(米)

Key Plan 索引圖

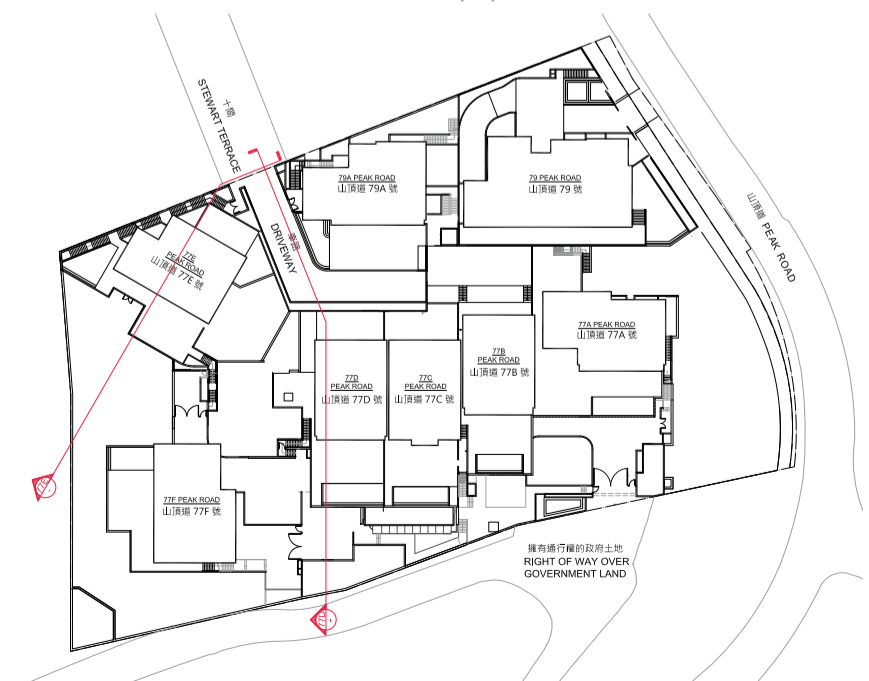

77F Peak Road 山頂道77F號 Cross-section Plan 1 橫截面圖1

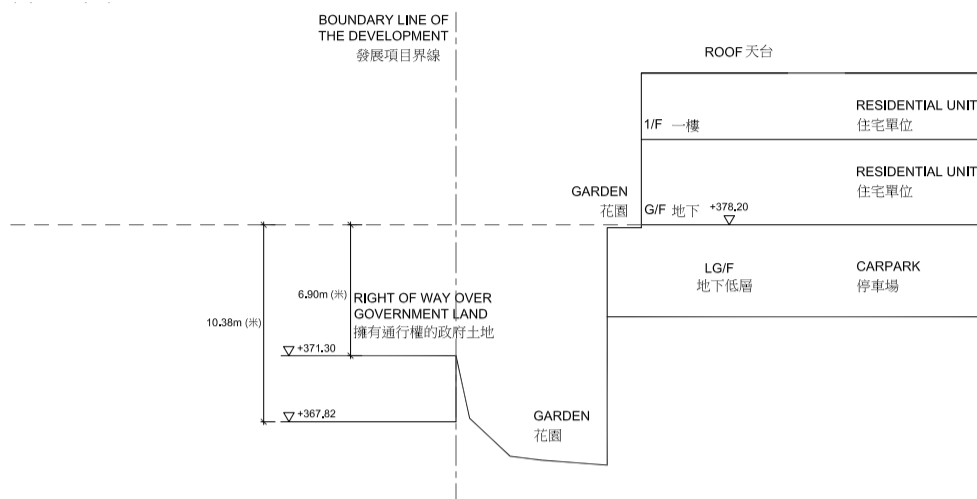

The part of Right of Way over Government Land adjacent to the building is 367.82 to 371.30 metres above the Hong Kong Principal Datum

毗連建築物的一段擁有通行權的政府土地為香港主水平基準以上367.82至371.30米

--- Dotted line denotes lowest residential floor
△ or ▽ donates height (in metres) above the Hong Kong Principal Datum

--- 虛線為最底住宅樓層水平
△ 或 ▽ 代表香港水平基準以上的高度(米)

77A, 77B, 77C, 77D and 77F Peak Road 山頂道77A, 77B, 77C, 77D及77F號
Cross-section Plan 2 橫截面圖2

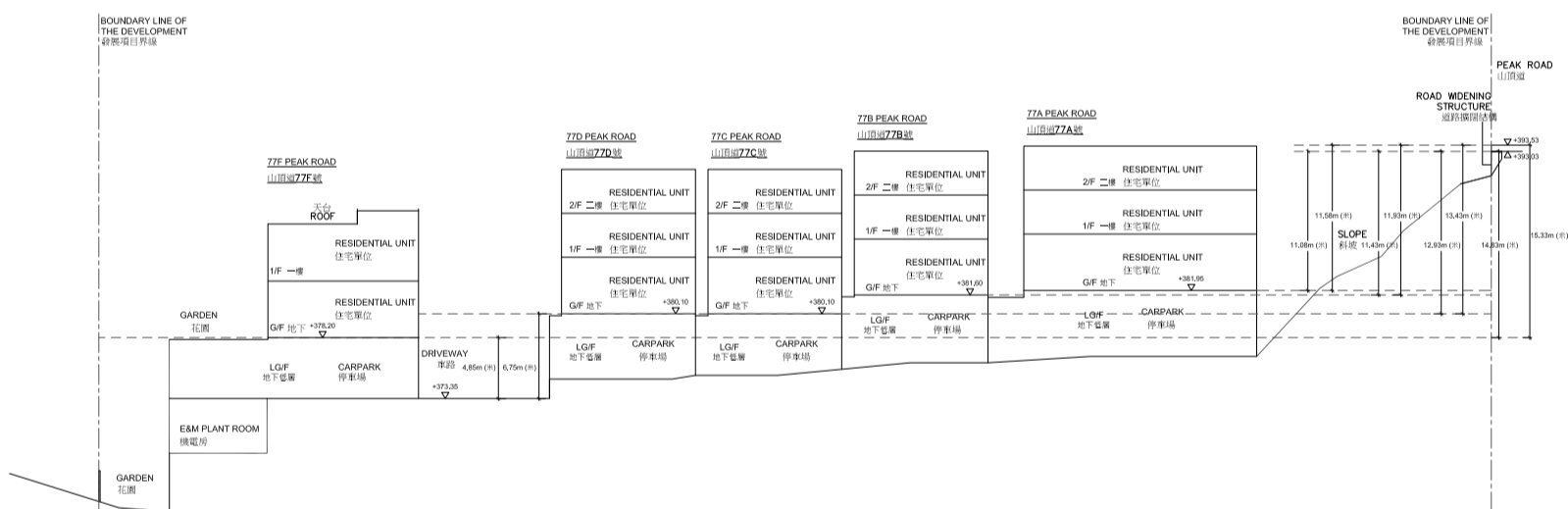

The part of Driveway adjacent to the building is 373.35 metres above the Hong Kong Principal Datum

毗連建築物的一段車路為香港主水平基準以上373.35米

The part of Peak Road adjacent to the building is 393.03 to 393.53 metres above the Hong Kong Principal Datum

毗連建築物的一段山頂道為香港主水平基準以上393.03至393.53米

--- Dotted line denotes lowest residential floor
△ or ▽ donates height (in metres) above the Hong Kong Principal Datum

--- 虛線為最底住宅樓層水平
△ 或 ▽ 代表香港水平基準以上的高度(米)

Key Plan
索引圖

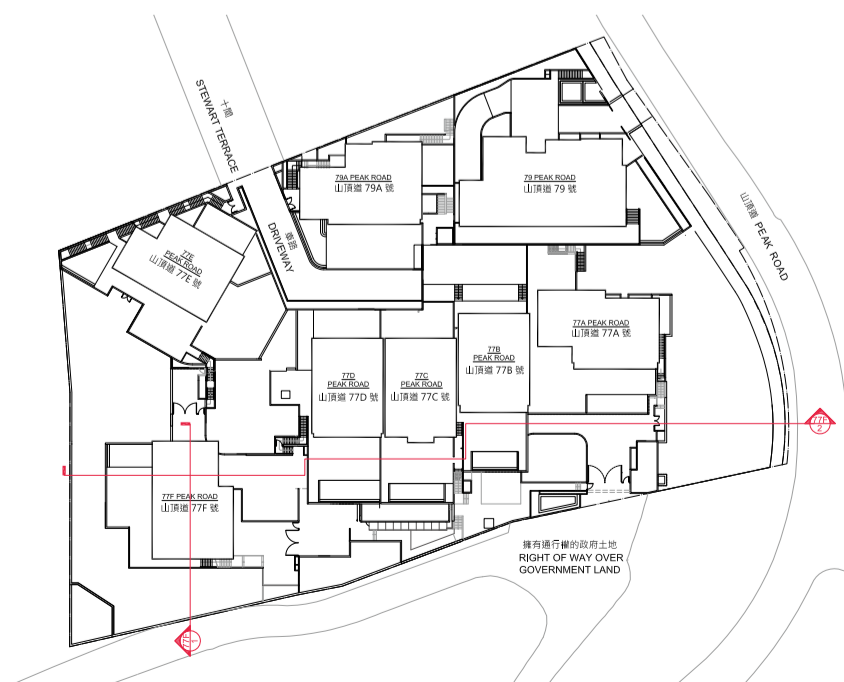

East Elevation
東面立面圖

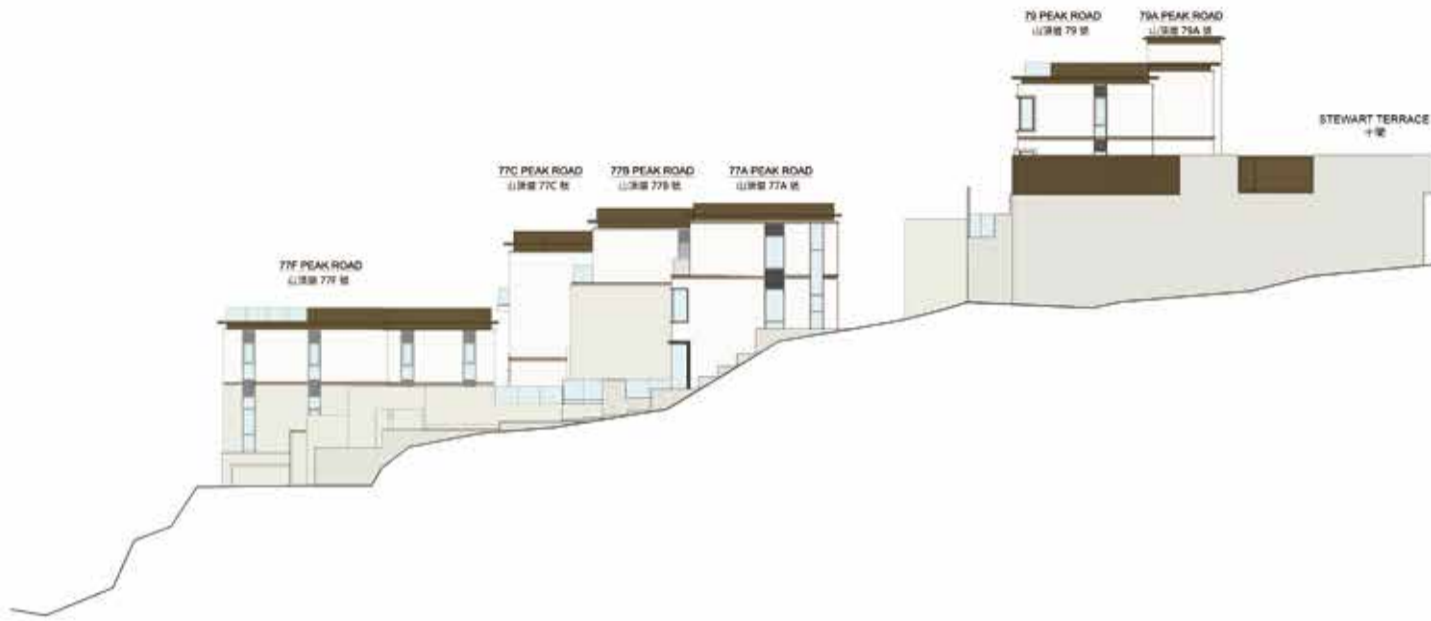

South Elevation
南面立面圖



Key Plan
索引圖



Authorized Person for the Development certified that the elevations shown on this elevation plan:

1. are prepared on the basis of the approved building plans for the Development as of 13 April 2015; and
2. are in general accordance with the outward appearance of the Development.

發展項目的認可人士證明本立面圖所顯示的立面：

1. 以2015年4月13日此發展項目經批准的建築圖則為基礎擬備；及
2. 大致上與該項目的外觀一致。

West Elevation
西面立面圖

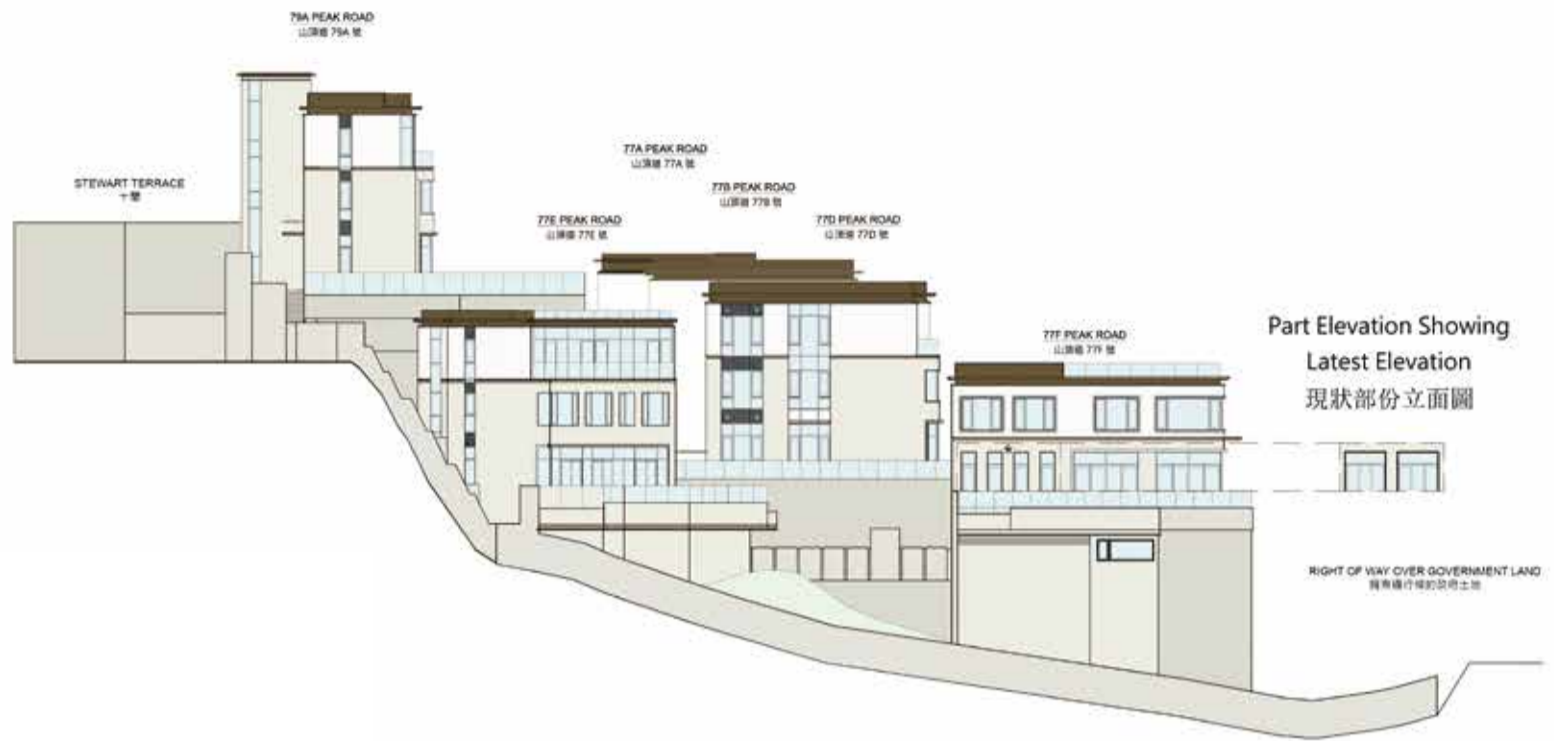

* This part of elevation has been altered by way of Addition & Alteration Works approved by Building Department after completion of the Development, the latest condition of which is shown on the relevant part elevation.

* 此部份因在發展項目落成後進行改建及加建工程獲批准的工程而有所改動，現狀請參考有關部份立面圖。

該等改動如下：

A. 改建為玻璃摺門。

The alteration works are as follows:

A. Alteration of folding glass door.

North Elevation
北面立面圖



Key Plan
索引圖



Authorized Person for the Development certified that the elevations shown on this elevation plan:

1. are prepared on the basis of the approved building plans for the Development as of 13 April 2015; and
2. are in general accordance with the outward appearance of the Development.

發展項目的認可人士證明本立面圖所顯示的立面：

1. 以2015年4月13日此發展項目經批准的建築圖則為基礎擬備；及
2. 大致上與該項目的外觀一致。

		Covered Area 有蓋面積	Uncovered Area 露天面積
Residents' Clubhouse (including any recreational facilities for residents' use) 住客會所 (包括供住客使用的任何康樂設施)	sq.ft. 平方呎	2104	N/A
	sq.m. 平方米	195.443	N/A
Communal garden or play area for residents' use on the roof, or on any floor between the roof and the lowest residential floor, of a building in the Development (whether known as a communal sky garden or otherwise) 位於發展項目中的建築物的天台或在天台和最低一層住宅樓層之間的任何 一層的、供住客使用的公用花園或遊樂地方 (不論是稱為公用空中花園或有其他名稱)	sq.ft. 平方呎	N/A	N/A
	sq.m. 平方米	N/A	N/A
Communal garden or play area for residents' use below the lowest residential floor of a building in the Development (whether known as a covered and landscaped play area or otherwise) 位於發展項目中的建築物的最低一層住宅樓層以下的、 供住客使用的公用花園或遊樂地方 (不論是稱為有蓋及園景的遊樂場或有其他名稱)	sq.ft. 平方呎	N/A	3048
	sq.m. 平方米	N/A	283.166

Note:

The areas as specified above in square feet are converted at a rate of 1 square metre = 10.764 square feet and rounded off to the nearest integer.

附註：

以平方呎顯示之面積以1平方米=10.764平方呎換算，並四捨五入至整數。

1. A copy of the Outline Zoning Plan relating to the Development is available at: <http://www.ozp.tpb.gov.hk>
 2. (a) A copy of every deed of mutual covenant in respect of the residential property that has been executed is available for inspection at the place at which the residential property is offered to be sold.
(b) The inspection is free of charge.
1. 備有關於本發展項目的分區計劃大綱圖的文本供閱覽的互聯網網站的網址為：<http://www.ozp.tpb.gov.hk>
 2. (a) 關於住宅物業的每一已簽立的公契存放在發售住宅物業的售樓處，以供閱覽。
(b) 無須為閱覽付費。

1. Exterior Finishes 外部裝修物料

Item 細項	Description	描述
(a) External wall 外牆	External Wall of House Finished with natural stone cladding, aluminium grilles and louvers with aluminium feature.	洋房外牆 鋪天然石材，鋁質裝飾組件及百葉並配以鋁質建築裝飾。
	External Wall of Podium 79+, 79A^ and 77F Peak Road Finished with natural stone cladding, texture paint, aluminium grilles and louvers with aluminium feature.	基座外牆 山頂道79+、79A^及77F號 鋪天然石材，紋理漆，鋁質裝飾組件及百葉並配以鋁質建築裝飾。
	77A, 77B, 77C, 77D and 77E Peak Road Finished with natural stone cladding, aluminium grilles and louvers with aluminium feature.	山頂道77A、77B、77C、77D及77E號 鋪天然石材，鋁質裝飾組件及百葉並配以鋁質建築裝飾。
(b) Window 窗	Aluminium windows frame 79+, 77A, 77B and 77E Peak Road Windows with double-glazed clear glass, triple-glazed clear glass, back-painted glass, heat strengthened glass and acid-etched glass (Insulated glass unit).	鋁質窗框 山頂道79+、77A、77B及77E號 窗戶採用雙層透明玻璃、三層透明玻璃、背漆玻璃、熱硬化玻璃及酸蝕玻璃(中空玻璃)。
	77C, 77D and 77F Peak Road Windows with double-glazed clear glass, back-painted glass, heat strengthened glass and acid-etched glass (Insulated glass unit).	山頂道77C、77D及77F號 窗戶採用雙層透明玻璃、背漆玻璃、熱硬化玻璃及酸蝕玻璃(中空玻璃)。
	79A Peak Road^ Windows with double-glazed clear glass, back-painted glass and heat strengthened glass (Insulated glass unit).	山頂道79A號^ 窗戶採用雙層透明玻璃、背漆玻璃及熱硬化玻璃(中空玻璃)。
(c) Bay window 窗台	Not Applicable.	不適用。
(d) Planter 花槽	Exterior of planter finished with natural stone.	花槽圍邊鋪天然石材。
(e) Verandah or balcony 陽台或露台	77C Peak Road Balcony is uncovered and finished with tempered glass balustrade and stone flooring.	山頂道77C號 露台不設上蓋，配設強化玻璃欄杆，地台鋪天然石材。
	There is no balcony for 79+, 79A^, 77A, 77B, 77D, 77E and 77F Peak Road	山頂道79+、79A^、77A、77B、77D、77E及77F號不設露台。
	There is no verandah for all houses.	所有洋房均不設陽台。
(f) Drying facilities for clothing 乾衣設施	Not Applicable.	不適用。

+ The above residential property is/was owned by Affluent Peak Limited. The shares of the holding company of the said company have been transferred and the said company has no longer been associated corporation of Wharf Peak Properties Limited. Information on the fittings, finishes and appliances of the above property set out in this sales brochure are based on the plans as at the date of the transfer.

^ The above residential property is/was owned by Deluxe Achieve Limited. The shares of the holding company of the said company have been transferred and the said company has no longer been associated corporation of Wharf Peak Properties Limited. Information on the fittings, finishes and appliances of the above property set out in this sales brochure are based on the plans as at the date of the transfer.

+ 上述住宅物業由Affluent Peak Limited擁有。該公司的控股公司的股份已轉讓，該公司不再是Wharf Peak Properties Limited的有聯繫法團。本售樓說明書所載上述物業的裝置、裝修物料及設備乃以轉讓日期的圖則為準。

^ 上述住宅物業由Deluxe Achieve Limited擁有。該公司的控股公司的股份已轉讓，該公司不再是Wharf Peak Properties Limited的有聯繫法團。本售樓說明書所載上述物業的裝置、裝修物料及設備乃以轉讓日期的圖則為準。

2. Interior Finishes 室內裝修物料

79 Peak Road 山頂道79號+

Item 細項	Description	描述
(a) Lobby 大堂	Lobby at Ground Floor: Floor finished with natural stone with timber skirting. Wall finished with wood veneer and metal inlay. Gypsum board false ceiling finished with emulsion paint.	地下大堂： 地台鋪天然石連木牆腳線。 牆身鋪木皮飾面配金屬飾面。 石膏板假天花髹乳膠漆。
(b) Internal wall and ceiling 內牆及天花板	Living Room: Wall finished with wood veneer; Exposed ceiling finished with plaster finish with emulsion paint; Gypsum board false ceiling finished with emulsion paint. Dining Room: Wall finished with wood veneer and mirror panel in metal frame; Exposed ceiling plastered with emulsion paint; Gypsum board false ceiling finished with emulsion paint. Ensuite 1: Wall finished with wood veneer and wallcovering; Exposed ceiling finished with plaster finish with emulsion paint; Gypsum board false ceiling finished with emulsion paint. Ensuite 2 and 3: Wall finished with wallcovering; Exposed ceiling with plaster finish with emulsion paint; Gypsum board false ceiling finished with emulsion paint. Master Ensuite: Wall finished with leather upholstered panel and wood veneer; Exposed ceiling finished with plaster finish with emulsion paint; Gypsum board false ceiling finished with emulsion paint.	客廳：牆身鋪木皮飾面；天花外露部分經批盪後再髹乳膠漆；石膏板假天花髹乳膠漆。 飯廳：牆身鋪木皮飾面及鏡面配金屬框；天花外露部分經批盪後再髹乳膠漆；石膏板假天花髹乳膠漆。 套房1：牆身鋪木皮飾面及牆紙；天花外露部分經批盪後再髹乳膠漆；石膏板假天花髹乳膠漆。 套房2及3：牆身鋪牆紙；天花外露部分經批盪後再髹乳膠漆；石膏板假天花髹乳膠漆。 主人套房：牆身鋪軟墊皮及木皮飾面；天花外露部分經批盪後再髹乳膠漆；石膏板假天花髹乳膠漆。
(c) Internal floor 內部地板	Living Room and Dining Room: Natural stone flooring and timber skirting. All Ensuities: Timber flooring and timber skirting.	客廳及飯廳：天然石地台連木牆腳線。 所有套房：木地板連木牆腳線。
(d) Bathroom 浴室	All Bathrooms (except Restroom in Store Room): Floor finished with natural stone. For Restroom in Store Room: Floor finished with porcelain tile. Master Bathroom, Bathroom 1-3 and Restroom in Family Room: Wall finished with natural stone up to false ceiling. No finishes to be provided above false ceiling. For Restroom in Store Room: Wall finished with porcelain tile up to false ceiling. No finishes to be provided above false ceiling. Gypsum board false ceiling finished with emulsion paint.	所有浴室(儲物室洗手間除外)：地台鋪天然石。儲物室洗手間：地台鋪瓷磚。 主人浴室、浴室1至3及起居室洗手間：牆身鋪天然石至假天花底。假天花以上不設任何裝修物料。 儲物室洗手間：牆身鋪瓷磚至假天花底。假天花以上不設任何裝修物料。 石膏板假天花髹乳膠漆。
(e) Kitchen 廚房	Floor finished with natural stone. Wall finished with natural stone, high gloss lacquered panels and wood veneered panels up to false ceiling. No finishes to be provided above false ceiling. Wall at the back of kitchen cabinet finished with reconstituted stone. Gypsum board false ceiling finished with emulsion paint. Cooking bench countertop finished with natural stone.	地台鋪天然石。 牆身鋪天然石、高光漆油飾面及木皮飾面至假天花底。假天花以上不設任何裝修物料。 廚櫃背後之牆身鋪人造石。 石膏板假天花髹乳膠漆。 灶台鋪天然石。

+ The above residential property is/was owned by Affluent Peak Limited. The shares of the holding company of the said company have been transferred and the said company has no longer been associated corporation of Wharf Peak Properties Limited. Information on the fittings, finishes and appliances of the above property set out in this sales brochure are based on the plans as at the date of the transfer.

+ 上述住宅物業由Affluent Peak Limited擁有。該公司的控權公司的股份已轉讓，該公司不再是Wharf Peak Properties Limited的有聯繫法團。本售樓說明書所載上述物業的裝置、裝修物料及設備乃以轉讓日期的圖則為準。

2. Interior Finishes 室內裝修物料

79A Peak Road 山頂道79A號[^]

Item 細項	Description	描述
(a) Lobby 大堂	Lobby at Lower Ground Floor Floor finished with natural stone with timber skirting. Wall finished with wood veneer and metal inlay. Gypsum board false ceiling finished with emulsion paint.	地下低層大堂 地台鋪天然石連木牆腳線。 牆身鋪木皮飾面配金屬飾面。 石膏板假天花髹乳膠漆。
(b) Internal wall and ceiling 內牆及天花板	Living Room and Dining Room: Wall finished with wood veneer; Exposed ceiling finished with plaster finish with emulsion paint; Gypsum board false ceiling finished with emulsion paint. Store Room, 1/F Foyer, 2/F Foyer: Wall finished with emulsion paint; Exposed ceiling finished with plaster finish with emulsion paint; Gypsum board false ceiling finished with emulsion paint. Ensuite 1-5, Dressing Room, Study Room, Family Room, Master Ensuite: Wall finished with wallcovering. Exposed ceiling finished with plaster finish with emulsion paint; Gypsum board false ceiling finished with emulsion paint.	客廳及飯廳：牆身鋪木皮飾面；天花外露部分經批盪後再髹乳膠漆；石膏板假天花髹乳膠漆。 儲物室、1樓前廳、2樓前廳：牆身髹乳膠漆；天花於外露部分經批盪後再髹乳膠漆；石膏板假天花髹乳膠漆。 套房1-5、衣帽間、書房、起居室、主人套房：牆身鋪砌牆紙；天花於外露部分經批盪後再髹乳膠漆；石膏板假天花髹乳膠漆。
(c) Internal floor 內部地板	Living Room and Dining Room: Natural stone flooring and timber skirting. All Ensuites: Timber flooring and timber skirting.	客廳及飯廳：天然石地台連木牆腳線。 所有套房：木地板連木牆腳線。
(d) Bathroom 浴室	All Bathrooms (except Restroom in Store Room): Floor finished with natural stone. For Restroom in Store Room: Floor finished with porcelain tile. Her Bathroom, G/F Bathroom and Bathroom 1-5: Wall finished with natural stone up to false ceiling. No finishes to be provided above false ceiling. For Restroom in Store Room: Wall finished with porcelain tile up to false ceiling. No finishes to be provided above false ceiling. Gypsum board false ceiling finished with emulsion paint.	所有浴室(儲物室洗手間除外)：地台鋪天然石。儲物室洗手間：地台鋪瓷磚。 女主人浴室、地下浴室及浴室1至5：牆身鋪天然石至假天花底。假天花以上不設任何裝修物料。 儲物室洗手間：牆身鋪瓷磚至假天花底。假天花以上不設任何裝修物料。 石膏板假天花髹乳膠漆。
(e) Kitchen 廚房	Floor finished with natural stone. Wall finished with natural stone and high gloss lacquered panels up to false ceiling. No finishes to be provided above false ceiling. Wall at the back of kitchen cabinet finished with reconstituted stone. Gypsum board false ceiling finished with emulsion paint. Cooking bench countertop finished with natural stone.	地台鋪天然石。 牆身鋪天然石及高光漆油飾面至假天花底。假天花以上不設任何裝修物料。 廚櫃背後之牆身鋪人造石。 石膏板假天花髹乳膠漆。 灶台鋪天然石。

[^] The above residential property is/was owned by Deluxe Achieve Limited. The shares of the holding company of the said company have been transferred and the said company has no longer been associated corporation of Wharf Peak Properties Limited. Information on the fittings, finishes and appliances of the above property set out in this sales brochure are based on the plans as at the date of the transfer.

[^] 上述住宅物業由Deluxe Achieve Limited擁有。該公司的控權公司的股份已轉讓，該公司不再是Wharf Peak Properties Limited的有聯繫法團。本售樓說明書所載上述物業的裝置、裝修物料及設備乃以轉讓日期的圖則為準。

2. Interior Finishes 室內裝修物料

77A Peak Road 山頂道77A號

Item 細項	Description	描述
(a) Lobby 大堂	Lobby at Lower Ground Floor Floor finished with natural stone with timber skirting. Wall finished with wood veneer and metal inlay. Gypsum board false ceiling finished with emulsion paint.	地下低層大堂 地台鋪天然石連木牆腳線。 牆身鋪木皮飾面配金屬飾面。 石膏板假天花髹乳膠漆。
(b) Internal wall and ceiling 內牆及天花板	Living Room and Dining Room: Wall finished with wood veneer; Exposed ceiling finished with plaster finish with emulsion paint; Gypsum board false ceiling finished with emulsion paint. Store Room, Family Room, 2/F Foyer: Wall finished with emulsion paint; Exposed ceiling finished with plaster finish with emulsion paint; Gypsum board false ceiling finished with emulsion paint. Ensuite 1-3, Dressing Room in Ensuite 3, Study Room, Master Ensuite, Her Dressing, His Dressing: Wall finished with wallcovering. Exposed ceiling finished with plaster finish with emulsion paint; Gypsum board false ceiling finished with emulsion paint.	客廳及飯廳：牆身鋪木皮飾面；天花外露部分經批盪後再髹乳膠漆；石膏板假天花髹乳膠漆。 儲物室、起居室、2樓前廳：牆身髹乳膠漆；天花於外露部分經批盪後再髹乳膠漆；石膏板假天花髹乳膠漆。 套房1-3、套房3內衣帽間、書房、主人套房、女主人衣帽間、男主人衣帽間：牆身鋪砌牆紙；天花於外露部分經批盪後再髹乳膠漆；石膏板假天花髹乳膠漆。
(c) Internal floor 內部地板	Living Room and Dining Room: Natural stone flooring and timber skirting. All Ensuities: Timber flooring and timber skirting.	客廳及飯廳：天然石地台連木牆腳線。 所有套房：木地板連木牆腳線。
(d) Bathroom 浴室	All Bathrooms (except Restroom in Store Room): Floor finished with natural stone. For Restroom in Store Room: Floor finished with porcelain tile. Master Bathroom and Bathroom 1-3: Wall finished with natural stone up to false ceiling. No finishes to be provided above false ceiling. For Restroom in Store Room: Wall finished with porcelain tile up to false ceiling. No finishes to be provided above false ceiling. Gypsum board false ceiling finished with emulsion paint.	所有浴室(儲物室洗手間除外)：地台鋪天然石。儲物室洗手間：地台鋪瓷磚。 主人浴室及浴室1至3：牆身鋪天然石至假天花底。假天花以上不設任何裝修物料。 儲物室洗手間：牆身鋪瓷磚至假天花底。假天花以上不設任何裝修物料。 石膏板假天花髹乳膠漆。
(e) Kitchen 廚房	Floor finished with natural stone. Wall finished with natural stone and high gloss lacquered panels up to false ceiling. No finishes to be provided above false ceiling. Wall at the back of kitchen cabinet finished with reconstituted stone. Gypsum board false ceiling finished with emulsion paint. Cooking bench countertop finished with natural stone.	地台鋪天然石。 牆身鋪天然石及高光漆油飾面至假天花底。假天花以上不設任何裝修物料。 廚櫃背後之牆身鋪人造石。 石膏板假天花髹乳膠漆。 灶台鋪天然石。

2. Interior Finishes 室內裝修物料

77B Peak Road 山頂道77B號

Item 細項	Description	描述
(a) Lobby 大堂	Lobby at Lower Ground Floor: Floor finished with natural stone with timber skirting. Wall finished with wood veneer and metal inlay. Gypsum board false ceiling finished with emulsion paint.	地下低層大堂： 地台鋪天然石連木牆腳線。 牆身鋪木皮飾面配金屬飾面。 石膏板假天花髹乳膠漆。
(b) Internal wall and ceiling 內牆及天花板	Living Room and Dining Room: Wall finished with wood veneer; Exposed ceiling finished with plaster finish with emulsion paint; Gypsum board false ceiling finished with emulsion paint. Store Room, 1/F Foyer, 2/F Foyer: Wall finished with emulsion paint; Exposed ceiling finished with plaster finish with emulsion paint; Gypsum board false ceiling finished with emulsion paint. Ensuite 1-3, Family Room, Dressing Room, Master Ensuite: Wall finished with wallcovering. Exposed ceiling finished with plaster finish with emulsion paint; Gypsum board false ceiling finished with emulsion paint.	客廳及飯廳：牆身鋪木皮飾面；天花外露部分經批盪後再髹乳膠漆；石膏板假天花髹乳膠漆。 儲物室、1樓前廳、2樓前廳：牆身髹乳膠漆；天花於外露部分經批盪後再髹乳膠漆；石膏板假天花髹乳膠漆。 套房1-3、起居室、衣帽間、主人套房：牆身鋪砌牆紙；天花於外露部分經批盪後再髹乳膠漆；石膏板假天花髹乳膠漆。
(c) Internal floor 內部地板	Living Room and Dining Room: Natural stone flooring and timber skirting. All Ensuites: Timber flooring and timber skirting.	客廳及飯廳：天然石地台連木牆腳線。 所有套房：木地板連木牆腳線。
(d) Bathroom 浴室	All Bathrooms (except Bathroom in Family Room): Floor finished with natural stone. For Bathroom in Family Room: Floor finished with porcelain tile. Master Bathroom and Bathroom 1-3: Wall finished with natural stone up to false ceiling. No finishes to be provided above false ceiling. For Bathroom in Family Room: Wall finished with porcelain tile up to false ceiling. No finishes to be provided above false ceiling. Gypsum board false ceiling finished with emulsion paint.	所有浴室(起居室浴室除外)：地台鋪天然石。起居室浴室：地台鋪瓷磚。 主人浴室及浴室1至3：牆身鋪天然石至假天花底。假天花以上不設任何裝修物料。 起居室浴室：牆身鋪瓷磚至假天花底。假天花以上不設任何裝修物料。 石膏板假天花髹乳膠漆。
(e) Kitchen 廚房	Floor finished with natural stone. Wall finished with natural stone and high gloss lacquered panels up to false ceiling. No finishes to be provided above false ceiling. Wall at the back of kitchen cabinet finished with reconstituted stone. Gypsum board false ceiling finished with emulsion paint. Cooking bench countertop finished with natural stone.	地台鋪天然石。 牆身鋪天然石及高光漆油飾面至假天花底。假天花以上不設任何裝修物料。 廚櫃背後之牆身鋪人造石。 石膏板假天花髹乳膠漆。 灶台鋪天然石。

2. Interior Finishes 室內裝修物料

77C Peak Road 山頂道77C號

Item 細項	Description	描述
(a) Lobby 大堂	Lobby at Lower Ground Floor: Floor finished with natural stone with emulsion paint on timber skirting. Wall finished with emulsion paint. Gypsum board false ceiling finished with emulsion paint.	地下低層大堂： 地台鋪天然石連髹乳膠漆的木牆腳線。 牆身髹乳膠漆。 石膏板假天花髹乳膠漆。
(b) Internal wall and ceiling 內牆及天花板	Living Room and Dining Room: Wall finished with emulsion paint and wall covering. Gypsum board false ceiling finished with emulsion paint. 1/F Foyer, 2/F Foyer: Wall finished with emulsion paint. Gypsum board false ceiling finished with emulsion paint. Ensuite 1: Wall finished with fabric upholstered panel with metal trim. Gypsum board false ceiling finished with emulsion paint. Ensuite 2 and 3, Dressing Room, Pantry: Wall finished with wallcovering. Gypsum board false ceiling finished with emulsion paint. Master Ensuite: Wall finished with wallcovering and fabric upholstered panel. Gypsum board false ceiling finished with emulsion paint.	客廳及飯廳：牆身髹乳膠漆及鋪牆紙；石膏板假天花髹乳膠漆。 一樓前廳、二樓前廳：牆身髹乳膠漆；石膏板假天花髹乳膠漆。 套房1：牆身鋪布飾面軟墊連金屬色條；石膏板假天花髹乳膠漆。 套房2及3、衣帽間、茶水間：牆身鋪牆紙；石膏板假天花髹乳膠漆。 主人睡房：牆身鋪牆紙及布飾面軟墊；石膏板假天花髹乳膠漆。
(c) Internal floor 內部地板	Living Room and Dining Room: Natural stone flooring and timber skirting with emulsion paint. All Ensuites: Timber flooring and timber skirting with emulsion paint.	客廳及飯廳：天然石地台連髹上乳膠漆的木牆腳線。 所有套房：木地板連髹上乳膠漆的木牆腳線。
(d) Bathroom 浴室	All Bathrooms (except First Floor Restroom): Floor finished with natural stone. For First Floor Restroom: Floor finished with porcelain tile. Master Bathroom and Bathroom 1-3: Wall finished with natural stone up to false ceiling. No finishes to be provided above false ceiling. For First Floor Restroom: Wall finished with porcelain tile up to false ceiling. No finishes to be provided above false ceiling. Gypsum board false ceiling finished with emulsion paint.	所有浴室(一樓洗手間除外)：地台鋪天然石。一樓洗手間：地台鋪瓷磚。 主人浴室、浴室1-3：牆身鋪天然石至假天花底。假天花以上不設任何裝修物料。 一樓洗手間：牆身鋪瓷磚至假天花底。假天花以上不設任何裝修物料。 石膏板假天花髹乳膠漆。
(e) Kitchen 廚房	Floor finished with natural stone. Wall finished with natural stone and wood veneered panels up to false ceiling. No finishes to be provided above false ceiling. Wall at the back of kitchen cabinet finished with reconstituted stone. Gypsum board false ceiling finished with emulsion paint. Cooking bench countertop finished with natural stone.	地台鋪天然石。 牆身鋪天然石及木皮飾面板至假天花底。假天花以上不設任何裝修物料。 廚櫃背後之牆身鋪人造石。 石膏板假天花髹乳膠漆。 灶台鋪天然石。

2. Interior Finishes 室內裝修物料

77D Peak Road 山頂道77D號

Item 細項	Description	描述
(a) Lobby 大堂	Lobby at Lower Ground Floor Floor finished with natural stone with timber skirting. Wall finished with wood veneer and metal inlay. Gypsum board false ceiling finished with emulsion paint.	地下低層大堂 地台鋪天然石連木牆腳線。 牆身鋪木皮飾面配金屬飾面。 石膏板假天花髹乳膠漆。
(b) Internal wall and ceiling 內牆及天花板	Living Room and Dining Room: Wall finished with wood veneer; Exposed ceiling finished with plaster finish with emulsion paint; Gypsum board false ceiling finished with emulsion paint. Family Room, 2/F Foyer, Store Room: Wall finished with emulsion paint; Exposed ceiling finished with plaster finish with emulsion paint; Gypsum board false ceiling finished with emulsion paint. Ensuite 1-3, Dressing Room, Master Ensuite: Wall finished with wallcovering; Exposed ceiling finished with plaster finish with emulsion paint; Gypsum board false ceiling finished with emulsion paint.	客廳及飯廳：牆身鋪木皮飾面；天花外露部分經批盪後再髹乳膠漆；石膏板假天花髹乳膠漆。 起居室、2樓前廳、儲物室：牆身髹乳膠漆；天花於外露部分經批盪後再髹乳膠漆；石膏板假天花髹乳膠漆。 套房1-3、衣帽間、主人套房：牆身鋪砌牆紙；天花於外露部分經批盪後再髹乳膠漆；石膏板假天花髹乳膠漆。
(c) Internal floor 內部地板	Living Room and Dining Room: Natural stone flooring and timber skirting. All Ensuites: Timber flooring and timber skirting.	客廳及飯廳：天然石地台連木牆腳線。 所有套房：地台鋪木地板連木牆腳線。
(d) Bathroom 浴室	All Bathrooms (except Restroom in Store room): Floor finished with natural stone. For Restroom in Store Room: Floor finished with porcelain tile. Master Bathroom and Bathroom 1-3: Wall finished with natural stone up to false ceiling. No finishes to be provided above false ceiling. Restroom in Store Room: Wall finished with porcelain tile up to false ceiling. No finishes to be provided above false ceiling. Gypsum board false ceiling finished with emulsion paint.	所有浴室(儲物室洗手間除外)：地台鋪天然石。儲物室洗手間：地台鋪瓷磚。 主人浴室及浴室1至3：牆身鋪天然石至假天花底。假天花以上不設任何裝修物料。 儲物室洗手間：牆身鋪瓷磚至假天花底。假天花以上不設任何裝修物料。 石膏板假天花髹乳膠漆。
(e) Kitchen 廚房	Floor finished with natural stone. Wall finished with natural stone and wood veneered panels up to false ceiling. No finishes to be provided above false ceiling. Wall at the back of kitchen cabinet finished with reconstituted stone. Gypsum board false ceiling finished with emulsion paint. Cooking bench countertop finished with natural stone.	地台鋪天然石。 牆身鋪天然石及木皮飾面至假天花底。假天花以上不設任何裝修物料。 廚櫃背後之牆身鋪人造石。 石膏板假天花髹乳膠漆。 灶台鋪天然石。

2. Interior Finishes 室內裝修物料

77E Peak Road 山頂道77E號

Item 細項	Description	描述
(a) Lobby 大堂	Lobby at Lower Ground Floor: Floor finished with natural stone with timber skirting. Wall finished with wood veneer and metal inlay. Gypsum board false ceiling finished with emulsion paint.	地下低層大堂： 地台鋪天然石連木牆腳線。 牆身鋪木皮飾面配金屬飾面。 石膏板假天花髹乳膠漆。
(b) Internal wall and ceiling 內牆及天花板	Living Room and Dining Room: Wall finished with wood veneer; Exposed ceiling finished with plaster finish with emulsion paint; Gypsum board false ceiling finished with emulsion paint. Store Room, 1/F Foyer, 2/F Foyer: Wall finished with emulsion paint; Exposed ceiling finished with plaster finish with emulsion paint; Gypsum board false ceiling finished with emulsion paint. Ensuite 1-5, Dressing Room, Master Ensuite: Wall finished with wallcovering. Exposed ceiling finished with plaster finish with emulsion paint; Gypsum board false ceiling finished with emulsion paint.	客廳及飯廳：牆身鋪木皮飾面；天花外露部分經批盪後再髹乳膠漆；石膏板假天花髹乳膠漆。 儲物室、1樓前廳、2樓前廳：牆身髹乳膠漆；天花於外露部分經批盪後再髹乳膠漆；石膏板假天花髹乳膠漆。 套房1-5、衣帽間、主人套房：牆身鋪砌牆紙；天花於外露部分經批盪後再髹乳膠漆；石膏板假天花髹乳膠漆。
(c) Internal floor 內部地板	Living Room and Dining Room: Natural stone flooring and timber skirting. All Ensuities: Timber flooring and timber skirting.	客廳及飯廳：天然石地台連木牆腳線。 所有套房：木地板連木牆腳線。
(d) Bathroom 浴室	All Bathrooms (except Restroom in Store Room): Floor finished with natural stone. For Restroom in Store Room: Floor finished with porcelain tile. Master Bathroom and Bathroom 1-5: Wall finished with natural stone up to false ceiling. No finishes to be provided above false ceiling. For Restroom in Store Room: Wall finished with porcelain tile up to false ceiling. No finishes to be provided above false ceiling. Gypsum board false ceiling finished with emulsion paint.	所有浴室(儲物室洗手間除外)：地台鋪天然石。儲物室洗手間：地台鋪瓷磚。 主人浴室及浴室1至5：牆身鋪天然石至假天花底。假天花以上不設任何裝修物料。 儲物室洗手間：牆身鋪瓷磚至假天花底。假天花以上不設任何裝修物料。 石膏板假天花髹乳膠漆。
(e) Kitchen 廚房	Floor finished with natural stone. Wall finished with natural stone and high gloss lacquered panels up to false ceiling. No finishes to be provided above false ceiling. Wall at the back of kitchen cabinet finished with reconstituted stone. Gypsum board false ceiling finished with emulsion paint. Cooking bench countertop finished with natural stone.	地台鋪天然石。 牆身鋪天然石及高光漆油飾面至假天花底。假天花以上不設任何裝修物料。 廚櫃背後之牆身鋪人造石。 石膏板假天花髹乳膠漆。 灶台鋪天然石。

2. Interior Finishes 室內裝修物料

77F Peak Road 山頂道77F號

Item 細項	Description	描述
(a) Lobby 大堂	Lobby at Lower Ground Floor Floor finished with natural stone with timber skirting. Wall finished with wood veneer and metal inlay. Gypsum board false ceiling finished with emulsion paint.	地下低層大堂 地台鋪天然石連木牆腳線。 牆身鋪木皮飾面配金屬飾面。 石膏板假天花髹乳膠漆。
(b) Internal wall and ceiling 內牆及天花板	Living Room and Dining Room: Wall finished with wood veneer; Exposed ceiling finished with plaster finish with emulsion paint; Gypsum board false ceiling finished with emulsion paint. Store Room, Foyer: Wall finished with emulsion paint; Exposed ceiling finished with plaster finish with emulsion paint; Gypsum board false ceiling finished with emulsion paint. Ensuite 1-3, Family Room, Master Ensuite, Dressing Room: Wall finished with wallcovering; Exposed ceiling finished with plaster finish with emulsion paint; Gypsum board false ceiling finished with emulsion paint.	客廳及飯廳：牆身鋪木皮飾面；天花外露部分經批盪後再髹乳膠漆；石膏板假天花髹乳膠漆。 儲物室、前廳：牆身髹乳膠漆；天花於外露部分經批盪後再髹乳膠漆；石膏板假天花髹乳膠漆。 套房1-3、起居室、主人套房、衣帽間：牆身鋪砌牆紙；天花於外露部分經批盪後再髹乳膠漆；石膏板假天花髹乳膠漆。
(c) Internal floor 內部地板	Living Room and Dining Room: Natural stone flooring and timber skirting. All Ensuites: Timber flooring and timber skirting.	客廳及飯廳：天然石地台連木牆腳線。 所有套房：木地板連木牆腳線。
(d) Bathroom 浴室	All Bathrooms (except Restroom in Store Room): Floor finished with natural stone. For Restroom in Store Room: Floor finished with porcelain tile. Master Bathroom and Bathroom 1-3: Wall finished with natural stone up to false ceiling. For Restroom in Store Room: Wall finished with porcelain tile up to false ceiling. No finishes to be provided above false ceiling. Gypsum board false ceiling finished with emulsion paint.	所有浴室(儲物室洗手間除外)：地台鋪天然石。儲物室洗手間：地台鋪瓷磚。 主人浴室及浴室1至3：牆身鋪天然石至假天花底。儲物室洗手間：牆身鋪瓷磚至假天花底。假天花以上不設任何裝修物料。 石膏板假天花髹乳膠漆。
(e) Kitchen 廚房	Floor finished with natural stone. Wall finished with natural stone and high gloss lacquered panels up to false ceiling. No finishes to be provided above false ceiling. Wall at the back of kitchen cabinet finished with reconstituted stone. Gypsum board false ceiling finished with emulsion paint. Cooking bench countertop finished with natural stone.	地台鋪天然石。 牆身鋪天然石及高光漆油飾面至假天花底。假天花以上不設任何裝修物料。 廚櫃背後之牆身鋪人造石。 石膏板假天花髹乳膠漆。 灶台鋪天然石。

3. Interior Fittings 室內裝置

79 Peak Road 山頂道79號+

Item 細項	Description	描述
(a) Doors 門	Main Gate Motorized metal gate. With side door, fitted with door lockset	大閘 機動金屬閘，帶有側門，裝有門鎖。
	Main door on Upper Ground Floor Solid core timber door with wood veneer and metal cladding, fitted with timber door frame, architrave, door lockset and door closer.	地面高層大門 實心木門配木皮飾面及金屬蓋板，裝有木門框、門楣、門鎖及門鼓。
	Door of Corridor with staircase to Exterior Metal door with metal cladding, fitted with metal door frame, architrave, door lockset and door closer.	樓梯走廊往室外門 金屬門配金屬蓋板，裝有金屬門框、門楣、門鎖及門鼓。
	Carpark Garage door Proprietary steel sectional garage door with silkgrain polyester primer coating. No accessories.	停車場車庫門 鍍鋅聚氨酯塗層鋼板車庫門，不設配件。
	Doors of Carpark to Corridor with staircase, outside A/C Plant Room and Filtration Plant Room Solid core timber door with metal cladding and plastic laminate, fitted with timber door frame, architrave, door lockset and door closer.	停車場往樓梯走廊門、空調機房及泳池濾水泵房外門 實心木門配有金屬蓋板及塑料層壓板，裝有木門框、門楣、門鎖及門鼓。
	Entry doors to Ground Floor Lobby, Carpark to Ground Floor Corridor and Ground Floor Corridor to Exterior Solid core timber door with metal cladding and wood veneer, fitted with timber door frame, architrave, door lockset and door closer.	往地下大堂入口、停車場往地下走廊及地下走廊往室外門 實心木門配金屬飾面及木皮飾面，裝有木門框、門楣、門鎖及門鼓。
	Door of Sprinkler Water Pump Room Solid core timber door with wood veneer and plastic laminate, fitted with timber door frame, architrave, door lockset and door closer.	消防花灑水泵房門 實心木門配木皮飾面及塑料層壓板，裝有木門框、門楣、門鎖及門鼓。
	Doors of A/C Plant Room, Filtration Plant Room, F.S. Pump Room and Potable and Flushing Water Pump Room Solid core timber door with plastic laminate, fitted with timber door frame, architrave, door lockset and door closer.	空調機房、泳池濾水泵房、消防泵房及食水及沖廁水泵房門 實心木門配塑料層壓板，裝有木門框、門楣、門鎖及門鼓。
	Door of Dining Room to Kitchen Solid core timber door with mirror panels in metal frame and wood veneer, fitted with timber door frame, architrave and door closer.	飯廳往廚房門 實心木門配鏡面連金屬框架及木皮飾面，裝有木門框、門楣及門鼓。
	Doors of Ensuite 1-3, Dressing Room in Ensuite 1 and 3 and Family Room Solid core timber door with wood veneer, fitted with timber door frame, architrave, door lockset and door closer.	套房1-3、套房1及3內衣帽間及起居室門 實心木門配木皮飾面，裝有木門框、門楣、門鎖及門鼓。
	Doors of Bathroom 1-3 Solid core timber door with wood veneer, lacquered paint finish, mirror and metal trim, fitted with timber door frame, architrave and door lockset.	浴室1-3門 實心木門配木皮飾面、漆油、鏡及金屬裝飾，裝有木門框、門楣及門鎖。
	Doors of Electrical Room, Ground Floor Lobby to F.S. Pump Room, Upper Ground Floor Store Room and Upper Ground Floor Restroom Solid core timber door with wood veneer, fitted with timber door frame, architrave, door lockset and door closer.	電錶房、地下大堂往消防泵房、地面高層儲物室及地面高層洗手間門 實心木門配木皮飾面，裝有木門框、門楣、門鎖及門鼓。
	Door of Ground Floor Lobby to Staircase Solid core timber door with wood veneer, fitted with timber door frame, architrave and door closer.	地下大堂往樓梯門 實心木門配木皮飾面，裝有木門框、門楣及門鼓。

+ The above residential property is/was owned by Affluent Peak Limited. The shares of the holding company of the said company have been transferred and the said company has no longer been associated corporation of Wharf Peak Properties Limited. Information on the fittings, finishes and appliances of the above property set out in this sales brochure are based on the plans as at the date of the transfer.

+ 上述住宅物業由Affluent Peak Limited擁有。該公司的控權公司的股份已轉讓，該公司不再是Wharf Peak Properties Limited的有聯繫法團。本售樓說明書所載上述物業的裝置、裝修物料及設備乃以轉讓日期的圖則為準。

3. Interior Fittings 室內裝置

79 Peak Road 山頂道79號

Item 細項	Description	描述
(a) Doors 門	Door of Master Ensuite Solid core timber door with wood veneer, fitted with timber door frame, architrave, door lockset and door closer.	主人套房門 實心木門配木皮飾面，裝有木門框、門楣、門鎖及門鼓。
	Door of Master Bathroom Glazed metal framed door, fitted with architrave, door lockset and door closer.	主人浴室門 金屬框架玻璃門，裝有門楣、門鎖及門鼓。
	Restroom in First Floor Family Room Solid core timber sliding door with wood veneer, fitted with timber door frame, architrave and door lockset.	一樓起居室洗手間門 實心木趟門配木皮飾面，裝有木門框、門楣及門鎖。
	Doors of Foyer to Kitchen Solid core timber sliding door with wood veneer, fitted with timber door frame, architrave and door lockset.	前廳往廚房 實心木趟門配木皮飾面，裝有木門框、門楣及門鎖。
	Library door Glazed sliding door in metal frame, fitted with timber door frame and architrave.	書房門 金屬框架玻璃趟門，裝有木門框及門楣。
	Door of Upper Ground Floor Restroom in Store Room Glazed door fitted with aluminum frame and door lockset.	地面高層儲物室洗手間門 鋁框架玻璃門，裝有門鎖。
	Doors of Living Room / Dining Room to Garden Glazed sliding door with aluminium frame fitted with door lockset.	客廳/飯廳往花園門 鋁框玻璃趟門，裝有門鎖。
	Doors of Ensuite 1 to Garden, Ensuite 1 Dressing Room to Garden and at Roof Glazed door with aluminium frame fitted with door lockset.	套房門1往花園、套房1衣帽間往花園及天台門 鋁框玻璃門，裝有門鎖。

3. Interior Fittings 室內裝置

79 Peak Road 山頂道79號

Item 細項	Description	描述
(b) Bathroom 浴室	<p>Bathroom 1 Fitted with natural stone countertop and sanitary wares and fittings include electroplated wash basin mixer, electroplated shower set, electroplated head shower, ceramic wash basin, shower cubicle with glass door and metal handle, ceramic water closet, electroplated towel bar, electroplated paper holder and wooden cabinet. For type and material of water supply system, please refer to "Water Supply" below.</p>	<p>浴室1 裝設天然石材檯面配以衛浴潔具及配件，包括電鍍洗手盆水龍頭、電鍍花灑套裝、電鍍頂部花灑、陶瓷洗手盆、淋浴間設玻璃門及金屬手柄、陶瓷坐廁、電鍍毛巾架、電鍍廁紙架及木櫃。 供水系統的類型及用料見下文「供水」一欄。</p>
	<p>Bathroom 2 Fitted with natural stone countertop and sanitary wares and fittings include electroplated wash basin mixer, electroplated shower set, electroplated head shower, ceramic wash basin, shower cubicle with glass door and metal handle, ceramic water closet, electroplated towel bar, electroplated paper holder and wooden cabinet. For type and material of water supply system, please refer to "Water Supply" below.</p>	<p>浴室2 裝設天然石材檯面配以衛浴潔具及配件，包括電鍍洗手盆水龍頭、電鍍花灑套裝、電鍍頂部花灑、陶瓷洗手盆、淋浴間設玻璃門及金屬手柄、陶瓷坐廁、電鍍毛巾架、電鍍廁紙架及木櫃。 供水系統的供水系統的類型及用料見下文「供水」一欄。</p>
	<p>Bathroom 3 Fitted with natural stone countertop and sanitary wares and fittings include electroplated wash basin mixer, electroplated bath mixer and shower set, ceramic wash basin, electroplated head shower, enameled steel bathtub (1800mm (L) x 800mm (W) x 410mm (D)), ceramic water closet, electroplated towel bar, electroplated paper holder and wooden cabinet. For type and material of water supply system, please refer to "Water Supply" below.</p>	<p>浴室3 裝設天然石材檯面配以衛浴潔具及配件，包括電鍍洗手盆水龍頭、電鍍浴缸水龍頭和花灑套裝、陶瓷洗手盆、電鍍頂部花灑、搪瓷鋼浴缸(1800毫米(長) x 800毫米(寬) x 410毫米(深))、陶瓷坐廁、電鍍毛巾架、電鍍廁紙架及木櫃。 供水系統的供水系統的類型及用料見下文「供水」一欄。</p>
	<p>Master Bathroom Fitted with natural stone countertop and sanitary wares and fittings include electroplated wash basin mixer, electroplated bath mixer and shower set, ceramic wash basin, electroplated head shower, cast iron bathtub (1829mm (L) x 914mm (W) x 524mm (D)), shower cubicle and wc cubicle with glass door and metal handle, ceramic water closet, electroplated towel warmer bar, electroplated paper holder and wooden cabinet. For type and material of water supply system, please refer to "Water Supply" below.</p>	<p>主人浴室 裝設天然石材檯面配以衛浴潔具及配件，包括電鍍洗手盆水龍頭、電鍍淋浴水龍頭及花灑套裝、陶瓷洗手盆、電鍍頂部花灑、鑄鐵浴缸(1829毫米(長) x 914毫米(寬) x 524毫米(深))、淋浴間及坐廁間配玻璃浴屏及金屬手柄、陶瓷坐廁、電鍍毛巾架、電鍍廁紙架及木櫃。 供水系統的類型及用料見下文「供水」一欄。</p>
	<p>Upper Ground Floor Restroom in Store Room Fitted with sanitary wares and fittings include electroplated wash basin mixer, electroplated shower set, ceramic wash basin, ceramic water closet. For type and material of water supply system, please refer to "Water Supply" below.</p>	<p>地面高層儲物室洗手間 裝設衛浴潔具及配件，包括電鍍洗手盆水龍頭、電鍍花灑套裝、陶瓷面盆、陶瓷坐廁。 供水系統的類型及用料見下文「供水」一欄。</p>
	<p>First Floor Restroom in Family Room Fitted with natural stone countertop and sanitary wares and fittings include electroplated wash basin mixer, electroplated shower set, electroplated head shower, ceramic wash basin, shower cubicle with glass door and metal handle, ceramic water closet, electroplated towel bar, electroplated paper holder and wooden cabinet. For type and material of water supply system, please refer to "Water Supply" below.</p>	<p>一樓起居室洗手間 裝設天然石材檯面配以衛浴潔具及配件，包括電鍍洗手盆水龍頭、電鍍花灑套裝、電鍍頂部花灑、陶瓷洗手盆、淋浴間設玻璃門及金屬手柄、陶瓷坐廁、電鍍毛巾架、電鍍廁紙架及木櫃。 供水系統的類型及用料見下文「供水」一欄。</p>

3. Interior Fittings 室內裝置

79 Peak Road 山頂道79號

Item 細項	Description	描述
(c) Kitchen 廚房	Fitted with wooden cabinet with both high gloss lacquered finish and wood veneered finish door panel, stainless steel sink with electroplated sink mixer. For material of water supply system, please refer to "Water Supply" below. For appliances provision, please refer to "Appliance Schedule". Sprinkler heads and smoke detector are installed.	裝設木製廚櫃配高光漆及木皮飾面門板、不銹鋼洗滌盆配以電鍍洗滌盆水龍頭。 供水系統的用料見下文「供水」一欄。 設備詳情請參考「設備說明表」。 設有消防花灑頭及煙霧偵測器。
(d) Bedroom 睡房	Not Applicable.	不適用。
(e) Telephone 電話	Telephone connection points are provided. For the number and the location of connection points, please refer to the "Schedule of Mechanical and Electrical Provisions".	設有電話接駁點。 有關接駁點之數目及位置，請參考「機電裝置數量說明表」。
(f) Aerials 天線	Communal TV and FM connection points are provided. For the number and location of connection points, please refer to the "Schedule of Mechanical and Electrical Provisions".	設有公共電視及FM電台接駁點。 有關接駁點之數目及位置，請參考「機電裝置數量說明表」。
(g) Electrical installations 電力裝置	Three phase electricity supply with miniature circuit breakers distribution boards complete with residual current protection is provided for individual houses. All conduits are concealed except those inside or enclosed by block wall, false ceiling, bulkhead, mouldings, cornices and cabinets. For the number and location of power points and air-conditioner points, please refer to the "Schedule of Mechanical and Electrical Provisions".	每座獨立屋均提供三相電力供電並備有配電箱及微型斷路器及包括漏電保護。 所有電線均採用隱藏式電線喉管安裝方法，除部份外露電線喉管藏於磚牆、假天花、假陣、石膏板圍邊、裝飾線及廚櫃內。 有關電插座及空調機接駁點之數目及位置，請參考「機電裝置數量說明表」。
(h) Gas supply 氣體供應	Town gas point is provided in Kitchen and connected to built-in gas cooking hob.	廚房內裝妥煤氣喉接駁內置煤氣煮食爐。
(i) Washing machine connection point 洗衣機接駁點	Washer dryer connection point is located in the Kitchen. Water point of a design of 22mm in diameter and drain point of a design of 40mm in diameter are provided.	洗衣乾衣機接駁點位於廚房。設有洗衣機來水接駁喉位 (其設計為直徑22毫米) 及去水接駁喉 (其設計為直徑40毫米)。
(j) Water supply 供水	PVC-coated copper pipes are provided for both hot and cold water supply. Water pipes are concealed in part and exposed in part. Exposed water pipes are enclosed by false ceiling or bulkhead. Hot water is available.	冷熱水喉管全部採用有膠層保護之銅喉。水管部份是隱藏、部份是外露的，外露的水管由假天花或假陣所圍封。有熱水供應。

3. Interior Fittings 室內裝置

79A Peak Road 山頂道79A號[^]

Item 細項	Description	描述
(a) Doors 門	Main Gate Motorized metal gate. No accessories.	大閘 機動金屬閘，不設配件。
	Main entry door Metal door with metal cladding, fitted with metal door frame, architrave, door lockset and door closer.	主入口門 金屬門配有金屬蓋板，裝有金屬門框、門楣、門鎖及門鼓。
	Door of Carpark Lift Lobby to Carpark Solid core timber door with wood veneer and metal cladding, fitted with timber door frame, architrave, door lockset and door closer.	往停車場電梯大堂門 實心木門配有木皮飾面及金屬蓋板，裝有木門框、門楣、門鎖及門鼓。
	Carpark Garage door Proprietary steel sectional garage door with wicket door with silkgrain polyester primer coating. No accessories.	停車場車庫門 鍍鋅聚氨酯塗層鋼板車庫門帶有方便門，不設配件。
	Doors of F.S. Pump Room, Filtration Plant Room, Potable and Flushing Water Pump Room, Sprinkler Water Pump Room and A/C Plant Room Solid core timber door with plastic laminate, fitted with timber door frame, architrave, door lockset and door closer.	消防泵房、泳池濾水泵房、食水及沖廁水泵房、消防花灑水泵房及空調機房門 實心木門及塑料層壓板，裝有木門框、門楣、門鎖及門鼓。
	Door of Electrical Room Metal door with paint and metal cladding, fitted with metal door frame, architrave, door lockset and door closer.	電錶房門 金屬門髹漆油及金屬蓋板，配有金屬門框、門楣、門鎖及門鼓。
	Doors of Carpark to Corridor outside Potable and Flushing Water Pump Room, F.S. Pump Room, Filtration Plant Room and staircase to TBE Room Solid core timber door with metal cladding and plastic laminate, fitted with timber door frame, architrave, door lockset and door closer.	停車場往食水及沖廁水泵房外走廊、消防泵房、泳池濾水泵房及樓梯往電訊及廣播設備機房門 實心木門配有金屬蓋板及塑料層壓板，裝有木門框、門楣、門鎖及門鼓。
	Door of staircase to Yard Solid core timber door with wood veneer and metal cladding, fitted with timber door frame, architrave, door lockset and door closer.	樓梯往庭院門 實心木門配木皮飾面及金屬蓋板，裝有木門框、門楣、門鎖及門鼓。
	Doors of Common Area to Open Court Entrance and Open Car Ramp to Common Area Metal door with metal cladding, fitted with door lockset.	公共地方往開放庭入口及露天汽車通道往公共地方門 金屬門配金屬蓋板，裝有門鎖。
	Doors of Ground Floor Bathroom, Her Bathroom and Bathrooms 1-5 Solid core timber door with wood veneer, lacquered paint finish, mirror and metal trim, fitted with timber door frame, architrave, door lockset and door closer.	地下浴室、女主人浴室及浴室1-5門 實心木門配有木皮飾面、漆油、鏡及金屬飾，裝有木門框、門楣、門鎖及門鼓。
	Doors of Sprinkler Water Pump Room and A/C Plant Room, Study Room, Family Room, Ensuite 1-5, Master Ensuite and Dressing room in Ensuite 4. Solid core timber door with wood veneer, fitted with timber door frame, architrave, door lockset and door closer.	消防花灑水泵房、空調機房、書房、起居室、套房1-5，主人套房及套房4內衣帽間門 實心木門配有木皮飾面，裝有木門框、門楣、門鎖及門鼓。
	Door of Carpark Lift Lobby to Staircase and Corridor Solid core timber door with wood veneer, fitted with timber door frame, architrave, door lockset and door closer.	停車場電梯大堂往樓梯及走廊門 實心木門配有木皮飾面，裝有木門框、門楣、門鎖及門鼓。
	Doors of Kitchen and Store Room Solid core timber door with wood veneer and high gloss lacquered finish, fitted with timber door frame, architrave, door lockset and door closer.	廚房及儲物室門 實心木門配有木皮飾面及高光漆，裝有木門框、門楣、門鎖及門鼓。

[^] The above residential property is/was owned by Deluxe Achieve Limited. The shares of the holding company of the said company have been transferred and the said company has no longer been associated corporation of Wharf Peak Properties Limited. Information on the fittings, finishes and appliances of the above property set out in this sales brochure are based on the plans as at the date of the transfer.

[^] 上述住宅物業由Deluxe Achieve Limited擁有。該公司的控權公司的股份已轉讓，該公司不再是Wharf Peak Properties Limited的有聯繫法團。本售樓說明書所載上述物業的裝置、裝修物料及設備乃以轉讓日期的圖則為準。

3. Interior Fittings 室內裝置

79A Peak Road 山頂道79A號

Item 細項	Description	描述
(a) Doors 門	Door of Restroom in Store Room Glazed folding door fitted with aluminum frame and door lockset.	儲物室內洗手間門 鋁框玻璃折疊門，裝有門鎖。
	Doors of Living Room and Dining Room to Garden, Study Room to Swimming Pool and Master Ensuite to Flat Roof Glazed sliding door with aluminum frame, fitted with door lockset.	客廳及飯廳往花園、書房往游泳池、主人套房往平台門 鋁框玻璃趟門，裝有門鎖。
	Doors of Dining Room to Exterior, Kitchen to Open Landscape Stair and Roof Glazed door with aluminum frame, fitted with door lockset.	飯廳往室外、廚房往開放式園林樓梯及天台門 鋁框配玻璃門，裝有門鎖。
(b) Bathroom 浴室	Ground Floor Bathroom Fitted with natural stone countertop and sanitary wares and fittings include electroplated wash basin mixer, electroplated shower set, electroplated head shower, ceramic wash basin, shower cubicle with glass door and metal handle, ceramic water closet, electroplated towel bar, electroplated paper holder and wooden cabinet. For type and material of water supply system, please refer to "Water Supply" below.	地下洗手間 裝設天然石材檯面配以衛浴潔具及配件，包括電鍍洗手盆水龍頭、電鍍花灑套裝、電鍍頂部花灑、陶瓷洗手盆、淋浴間設玻璃門及金屬手柄、陶瓷坐廁、電鍍毛巾架、電鍍廁紙架及木櫃。 供水系統的類型及用料見下文「供水」一欄。
	Bathroom 1 Fitted with natural stone countertop and sanitary wares and fittings include electroplated wash basin mixer, electroplated shower set, electroplated head shower, ceramic wash basin, shower cubicle with glass door and metal handle, ceramic water closet, electroplated towel bar, electroplated paper holder and wooden cabinet. For type and material of water supply system, please refer to "Water Supply" below.	浴室1 裝設天然石材檯面配以衛浴潔具及配件，包括電鍍洗手盆水龍頭、電鍍花灑套裝、電鍍頂部花灑、陶瓷洗手盆、淋浴間設玻璃門及金屬手柄、陶瓷坐廁、電鍍毛巾架、電鍍廁紙架及木櫃。 供水系統的類型及用料見下文「供水」一欄。
	Bathroom 2 Fitted with natural stone countertop and sanitary wares and fittings include electroplated wash basin mixer, electroplated shower set, electroplated head shower, ceramic wash basin, shower cubicle with glass door and metal handle, ceramic water closet, electroplated towel bar, electroplated paper holder and wooden cabinet. For type and material of water supply system, please refer to "Water Supply" below.	浴室2 裝設天然石材檯面配以衛浴潔具及配件，包括電鍍洗手盆水龍頭、電鍍花灑套裝、電鍍頂部花灑、陶瓷洗手盆、淋浴間設玻璃門及金屬手柄、陶瓷坐廁、電鍍毛巾架、電鍍廁紙架及木櫃。 供水系統的類型及用料見下文「供水」一欄。

3. Interior Fittings 室內裝置

79A Peak Road 山頂道79A號

Item 細項	Description	描述
(b) Bathroom 浴室	<p>Bathroom 3</p> <p>Fitted with natural stone countertop and sanitary wares and fittings include electroplated wash basin mixer, electroplated shower set, electroplated head shower, ceramic wash basin, shower cubicle with glass door and metal handle, ceramic water closet, electroplated towel bar, electroplated paper holder and wooden cabinet.</p> <p>For type and material of water supply system, please refer to "Water Supply" below.</p>	<p>浴室3</p> <p>裝設天然石材檯面配以衛浴潔具及配件，包括電鍍洗手盆水龍頭、電鍍花灑套裝、電鍍頂部花灑、陶瓷洗手盆、淋浴間設玻璃門及金屬手柄、陶瓷坐廁、電鍍毛巾架、電鍍廁紙架及木櫃。</p> <p>供水系統的類型及用料見下文「供水」一欄。</p>
	<p>Bathroom 4</p> <p>Fitted with natural stone countertop and sanitary wares and fittings include electroplated wash basin mixer, electroplated bath mixer and shower set, electroplated head shower, ceramic wash basin, enameled steel bathtub (1700mm (L) x 800mm (W) x 420mm (D)), ceramic water closet, electroplated towel bar, electroplated paper holder and wooden cabinet.</p> <p>For type and material of water supply system, please refer to "Water Supply" below.</p>	<p>浴室4</p> <p>裝設天然石材檯面配以衛浴潔具及配件，包括電鍍洗手盆水龍頭、電鍍淋浴室龍頭及花灑套裝、電鍍頂部花灑、陶瓷洗手盆、搪瓷鋼浴缸(1700毫米(長) x 800毫米(寬) x 420毫米(深))、陶瓷坐廁、電鍍毛巾架、電鍍廁紙架及木櫃。</p> <p>供水系統的類型及用料見下文「供水」一欄。</p>
	<p>Bathroom 5</p> <p>Fitted with natural stone countertop and sanitary wares and fittings include electroplated wash basin mixer, electroplated bath mixer and shower set, electroplated head shower, ceramic wash basin, enameled steel bathtub (1700mm (L) x 800mm (W) x 420mm (D)), ceramic water closet, electroplated towel bar, electroplated paper holder and wooden cabinet.</p> <p>For type and material of water supply system, please refer to "Water Supply" below.</p>	<p>浴室5</p> <p>裝設天然石材檯面配以衛浴潔具及配件，包括電鍍洗手盆水龍頭、電鍍淋浴室龍頭及花灑套裝、電鍍頂部花灑、陶瓷洗手盆、搪瓷鋼浴缸(1700毫米(長) x 800毫米(寬) x 420毫米(深))、陶瓷坐廁、電鍍毛巾架、電鍍廁紙架及木櫃。</p> <p>供水系統的類型及用料見下文「供水」一欄。</p>
	<p>Her Bathroom</p> <p>Fitted with natural stone countertop and sanitary wares and fittings include electroplated wash basin mixer, electroplated bath mixer and shower set, electroplated head shower, ceramic wash basin, cast iron bathtub (1822mm (L) x 914mm (W) x 530mm (D)), shower cubicle and wc cubicle with glass door and metal handle, ceramic water closet, electroplated towel warmer, electroplated towel bar, electroplated paper holder and wooden cabinet.</p> <p>For type and material of water supply system, please refer to "Water Supply" below.</p>	<p>女主人浴室</p> <p>裝設天然石材檯面配以衛浴潔具及配件，包括電鍍洗手盆水龍頭、電鍍淋浴室龍頭及花灑套裝、電鍍頂部花灑、陶瓷洗手盆、鑄鐵浴缸(1822毫米(長) x 914毫米(寬) x 530毫米(深))、淋浴間及坐廁間配玻璃浴屏及金屬手柄、陶瓷坐廁、電鍍毛巾架、電鍍廁紙架及木櫃。</p> <p>供水系統的類型及用料見下文「供水」一欄。</p>
	<p>Ground Floor Restroom in Store Room</p> <p>Fitted with sanitary wares and fittings include electroplated wash basin mixer, electroplated shower set, ceramic wash basin, ceramic water closet.</p> <p>For type and material of water supply system, please refer to "Water Supply" below.</p>	<p>地下儲物室洗手間</p> <p>裝設衛浴潔具及配件，包括電鍍洗手盆水龍頭、電鍍花灑套裝、陶瓷洗手盆、陶瓷坐廁。</p> <p>供水系統的類型及用料見下文「供水」一欄。</p>

3. Interior Fittings 室內裝置

79A Peak Road 山頂道79A號

Item 細項	Description	描述
(c) Kitchen 廚房	Fitted with wooden cabinet with high gloss lacquered finish door panel, stainless steel sink with electroplated sink mixer. For material of water supply system, please refer to "Water Supply" below. For appliances provision, please refer to "Appliance Schedule".	裝設木製廚櫃配高光漆門板、不銹鋼洗滌盆配以電鍍洗滌盆水龍頭。 供水系統的用料見下文「供水」一欄。 設備詳情請參考「設備說明表」。
(d) Bedroom 睡房	Not Applicable.	不適用。
(e) Telephone 電話	Telephone connection points are provided. For the number and the location of connection points, please refer to the "Schedule of Mechanical and Electrical Provisions".	設有電話接駁點。 有關接駁點之數目及位置，請參考「機電裝置數量說明表」。
(f) Aerials 天線	Communal TV and FM connection points are provided. For the number and location of connection points, please refer to the "Schedule of Mechanical and Electrical Provisions".	設有公共電視及FM電台接駁點。 有關接駁點之數目及位置，請參考「機電裝置數量說明表」。
(g) Electrical installations 電力裝置	Three phase electricity supply with miniature circuit breakers distribution boards complete with residual current protection is provided for individual houses. For the number and location of power points and air-conditioner points, please refer to the "Schedule of Mechanical and Electrical Provisions".	每座獨立屋均提供三相電力供電並備有配電箱及微型斷路器及包括漏電保護。 有關電插座及空調機接駁點之數目及位置，請參考「機電裝置數量說明表」。
(h) Gas supply 氣體供應	Town Gas point is provided in Kitchen, gas hob to be installed by purchaser.	廚房內設有煤氣喉接駁點，煤氣爐由買家安裝。
(i) Washing machine connection point 洗衣機接駁點	Washer dryer connection point is located in the Kitchen. Water point of a design of 22mm in diameter and drain point of a design of 40mm in diameter are provided.	洗衣乾衣機接駁點位於廚房。設有洗衣機來水接駁喉位 (其設計為直徑22毫米) 及去水接駁喉 (其設計為直徑40毫米)。
(j) Water supply 供水	PVC-coated copper pipes are provided for both hot and cold water supply. Water pipes are concealed in part and exposed in part. Exposed water pipes are enclosed by false ceiling or bulkhead. Hot water is available.	冷熱水喉管全部採用有膠層保護之銅喉。水管部份是隱藏、部份是外露的，外露的水管由假天花或假陣所圍封。有熱水供應。

3. Interior Fittings 室內裝置

77A Peak Road 山頂道77A號

Item 細項	Description	描述
(a) Doors 門	Main entry door and door of Carpark Lift Lobby to Carpark Solid core timber door with wood veneer and metal cladding, fitted with timber door frame, architrave, door lockset and door closer.	主入口門及停車場電梯大堂往停車場門 實心木門配木皮飾面及金屬蓋板，裝有木門框、門楣、門鎖及門鼓。
	Carpark Garage door Proprietary steel sectional garage door with silkgrain polyester primer coating. No accessories.	停車場車庫門 鍍鋅聚氨酯塗層鋼板車庫門，不設配件。
	Door of Carpark to Corridor outside A/C Plant Room Solid core timber door with metal cladding and plastic laminate, fitted with timber door frame, architrave, door lockset and door closer.	停車場往空調機房外走廊門 實心木門裝有金屬蓋板及塑料層壓板，裝有木門框、門楣、門鎖及門鼓。
	Door to Carpark Proprietary steel door with polyester primer coating, fitted with door lockset.	停車場門 聚氨酯塗層鋼板門，裝有門鎖。
	Door of Carpark Lift Lobby to Corridor Solid core timber door with wood veneer, fitted with timber door frame, architrave, door lockset and door closer.	停車場電梯大堂往走廊門 實心木門配木皮飾面，裝有木門框、門楣、門鎖及門鼓。
	Door of Carpark Lift Lobby to Staircase Solid core timber door with wood veneer, fitted with timber door frame, architrave and door closer.	停車場電梯大堂往樓梯門 實心木門配木皮飾面，裝有木門框、門楣及門鼓。
	Doors of Ensuite 1-3, His Dressing Room, Study Room, First Floor Restroom, Store Room and Her Dressing Room Solid core timber door with wood veneer, fitted with timber door frame door, architrave, door lockset and door closer.	套房1-3、男主人衣帽間、書房、一樓洗手間、儲物室及女主人衣帽間門 實心木門配木皮飾面，配木門框、門楣、門鎖及門鼓。
	Doors of Bathroom 1-3 Solid core timber door with wood veneer, lacquered paint finish, mirror and metal trim, fitted with timber door frame, architrave, door lockset and door closer.	浴室1-3門 實心木門配木皮飾面、漆油、鏡及金屬裝飾，裝有木門框、門楣、門鎖及門鼓。
	Kitchen door Solid core timber door with wood veneer and high gloss lacquered finish, fitted with timber door frame, architrave, door lockset and door closer.	廚房門 實心木門配木皮飾面及高光漆，裝有木門框、門楣、門鎖及門鼓。
	Doors of Ground Floor Restroom, Master Ensuite and Ensuite 3 Dressing Room Solid core timber sliding door with wood veneer, fitted with timber door frame, architrave and door lockset.	地下洗手間、主人套房及套房3內衣帽間門 實心木趟門配木皮飾面，裝有木門框、門楣及門鎖。
	Doors of Ground Floor Store Room Solid core timber sliding door with wood veneer and high gloss lacquered finish, fitted with timber door frame, architrave and door lockset.	地下儲物室門 實心木趟門配木皮飾面及高光漆，裝有木門框、門楣及門鎖。
	Doors of A/C Plant Room, Filtration Plant Room, Potable and Flushing Water Pump Room, F.S. and Sprinkler Water Pump Room and Electrical Room, doors of corridor to Common Area and corridor outside Potable and Flushing Water Pump Room, F.S. and Sprinkler Water Pump Room and Electrical Room Solid core timber door with plastic laminate finish, fitted with timber door frame, architrave, door lockset and door closer.	空調機房、泳池濾水泵房、食水及沖廁水泵房、消防泵及消防花灑水泵房及電錶房，走廊往公共地方及食水及沖廁水泵房外走廊、消防泵及消防花灑水泵房及電錶房門 實心木門帶塑料層壓板表面，裝有木門框、門楣、門鎖及門鼓。
	Door of Common Area to open staircase to Entrance Lobby Metal door with metal cladding, fitted with door lockset.	公共地方往通往入口大堂之露天樓梯的門 金屬門配金屬蓋板，裝有門鎖。

3. Interior Fittings 室內裝置

77A Peak Road 山頂道77A號

Item 細項	Description	描述
(a) Doors 門	<p>Door of Master Bathroom</p> <p>Solid core timber sliding door with wood veneer, lacquered paint finish, mirror and metal trim, fitted with timber door frame, architrave, and door lockset.</p>	<p>主人浴室門</p> <p>實心木趟門配木皮飾面及漆油、鏡及金屬裝飾，裝有木門框、門楣及門鎖。</p>
	<p>Door of Ground Floor Restroom in Store Room</p> <p>Glazed folding door fitted with aluminum frame, fitted with door lockset.</p>	<p>地下儲物室內洗手間門</p> <p>鋁框玻璃折疊門，裝有門鎖。</p>
	<p>Doors of Living Room, Dining Room and Kitchen to Garden and Master Ensuite to Flat Roof</p> <p>Glazed sliding door with aluminum frame, fitted with door lockset.</p>	<p>客廳、飯廳及廚房往花園、主人套房往平台門</p> <p>鋁框玻璃趟門，裝有門鎖。</p>
	<p>Doors of Dining Room to Garden, area outside Store Room to Yard, Family Room and Study Room to Garden</p> <p>Glazed door with aluminum frame, fitted with door lockset.</p>	<p>飯廳往花園、儲物室外位置往庭院、起居室及書房往花園門</p> <p>鋁框玻璃門，裝有門鎖。</p>
(b) Bathroom 浴室	<p>Bathroom 1</p> <p>Fitted with natural stone countertop and sanitary wares and fittings include electroplated wash basin mixer, electroplated bath mixer and shower set, electroplated head shower, ceramic wash basin, enameled steel bathtub (1700mm (L) x 800mm (W) x 420mm (D)), ceramic water closet, electroplated towel bar, electroplated paper holder and wooden cabinet.</p> <p>For type and material of water supply system, please refer to "Water Supply" below.</p>	<p>浴室1</p> <p>裝設天然石材檯面配以衛浴潔具及配件，包括電鍍洗手盆水龍頭、電鍍淋浴水龍頭及花灑套裝、電鍍頂部花灑、陶瓷洗手盆、搪瓷鋼浴缸(1700毫米(長) x 800毫米(寬) x 420毫米(深))、陶瓷坐廁、電鍍毛巾架、電鍍廁紙架及木櫃。</p> <p>供水系統的類型及用料見下文「供水」一欄。</p>
	<p>Bathroom 2</p> <p>Fitted with natural stone countertop and sanitary wares and fittings include electroplated wash basin mixer, electroplated shower set, electroplated head shower, ceramic wash basin, shower cubicle with glass door and metal handle, ceramic water closet, electroplated towel bar, electroplated paper holder and wooden cabinet.</p> <p>For type and material of water supply system, please refer to "Water Supply" below.</p>	<p>浴室2</p> <p>裝設天然石材檯面配以衛浴潔具及配件，包括電鍍洗手盆水龍頭、電鍍花灑套裝、電鍍頂部花灑、陶瓷洗手盆、淋浴間設玻璃門及金屬手柄、陶瓷坐廁、電鍍毛巾架、電鍍廁紙架及木櫃。</p> <p>供水系統的類型及用料見下文「供水」一欄。</p>
	<p>Bathroom 3</p> <p>Fitted with natural stone countertop and sanitary wares and fittings include electroplated wash basin mixer, electroplated bath mixer and shower set, electroplated head shower, ceramic wash basin, enameled steel bathtub (1800mm (L) x 800mm (W) x 410mm (D)), ceramic water closet, electroplated towel bar, electroplated paper holder and wooden cabinet.</p> <p>For type and material of water supply system, please refer to "Water Supply" below.</p>	<p>浴室3</p> <p>裝設天然石材檯面配以衛浴潔具及配件，包括電鍍洗手盆水龍頭、電鍍淋浴水龍頭及花灑套裝、電鍍頂部花灑、陶瓷洗手盆、搪瓷鋼浴缸(1800毫米(長) x 800毫米(寬) x 410毫米(深))、陶瓷坐廁、電鍍毛巾架、電鍍廁紙架及木櫃。</p> <p>供水系統的類型及用料見下文「供水」一欄。</p>

3. Interior Fittings 室內裝置

77A Peak Road 山頂道77A號

Item 細項	Description	描述
(b) Bathroom 浴室	<p>Master Bathroom Fitted with natural stone countertop and sanitary wares and fittings include electroplated wash basin mixer, electroplated bath mixer and shower set, electroplated head shower, ceramic wash basin, cast iron bathtub (1822mm (L) x 914mm (W) x 530mm (D)), shower cubicle and wc cubicle with glass door and metal handle, ceramic water closet electroplated towel warmer, electroplated paper holder and wooden cabinet.</p> <p>For type and material of water supply system, please refer to "Water Supply" below.</p> <p>Ground Floor Restroom in Store Room Fitted with sanitary wares and fittings include electroplated wash basin mixer, electroplated shower set, ceramic wash basin, ceramic water closet.</p> <p>For type and material of water supply system, please refer to "Water Supply" below.</p>	<p>主人浴室 裝設天然石材檯面配以衛浴潔具及配件，包括電鍍洗手盆水龍頭、電鍍淋浴水龍頭及花灑套裝、電鍍頂部花灑、陶瓷洗手盆、鑄鐵浴缸(1822毫米(長) x 914毫米(寬) x 530毫米(深))、淋浴間及坐廁間配玻璃浴屏及金屬手柄、陶瓷坐廁、電鍍毛巾暖架、電鍍廁紙架及木櫃。</p> <p>供水系統的類型及用料見下文「供水」一欄。</p> <p>地下儲物室洗手間 裝設衛浴潔具及配件，包括電鍍洗手盆水龍頭、電鍍花灑套裝、陶瓷洗手盆、陶瓷坐廁。</p> <p>供水系統的類型及用料見下文「供水」一欄。</p>
(c) Kitchen 廚房	<p>Fitted with wooden cabinet with high gloss lacquered finish door panel, stainless steel sink with electroplated sink mixer.</p> <p>For material of water supply system, please refer to "Water Supply" below.</p> <p>For appliances provision, please refer to "Appliance Schedule".</p>	<p>裝設木製廚櫃配高光漆門板、不銹鋼洗滌盆配以電鍍洗滌盆水龍頭。</p> <p>供水系統的用料見下文「供水」一欄。</p> <p>設備詳情請參考「設備說明表」。</p>
(d) Bedroom 睡房	Not Applicable.	不適用。
(e) Telephone 電話	<p>Telephone connection points are provided.</p> <p>For the number and location of connection points, please refer to the "Schedule of Mechanical and Electrical Provisions".</p>	<p>設有電話接駁點。</p> <p>有關接駁點之數目及位置，請參考「機電裝置數量說明表」。</p>
(f) Aerials 天線	<p>Communal TV and FM connection points are provided.</p> <p>For the number and location of connection points, please refer to the "Schedule of Mechanical and Electrical Provisions".</p>	<p>設有公共電視及FM電台接駁點。</p> <p>有關接駁點之數目及位置，請參考「機電裝置數量說明表」。</p>
(g) Electrical installations 電力裝置	<p>Three phase electricity supply with miniature circuit breakers distribution boards complete with residual current protection is provided for individual houses.</p> <p>All conduits are concealed except those inside or enclosed by block wall, false ceiling, bulkhead, mouldings, cornices and cabinets.</p> <p>For the number and location of power points and air-conditioner points, please refer to the "Schedule of Mechanical and Electrical Provisions".</p>	<p>每座獨立屋均提供三相電力供電並備有配電箱及微型斷路器及包括漏電保護。</p> <p>所有電線均採用隱藏式電線喉管安裝方法，除部份外露電線喉管藏於磚牆、假天花、假陣、石膏板圍邊、裝飾線及廚櫃內。</p> <p>有關電插座及空調機接駁點之數目及位置，請參考「機電裝置數量說明表」。</p>
(h) Gas supply 氣體供應	Town gas point is provided in Kitchen and connected to built-in gas cooking hob.	廚房內裝妥煤氣喉接駁內置煤氣煮食爐。
(i) Washing machine connection point 洗衣機接駁點	Washer dryer connection point is located in the Kitchen. Water point of a design of 22mm in diameter and drain point of a design of 40mm in diameter are provided.	洗衣乾衣機接駁點位於廚房。設有洗衣機來水接駁喉位(其設計為直徑22毫米)及去水接駁喉(其設計為直徑40毫米)。
(j) Water supply 供水	PVC-coated copper pipes are provided for both hot and cold water supply. Water pipes are concealed in part and exposed in part. Exposed water pipes are enclosed by false ceiling or bulkhead. Hot water is available.	冷熱水喉管全部採用有膠層保護之銅喉。水管部份是隱藏、部份是外露的，外露的水管由假天花或假陣所圍封。有熱水供應。

3. Interior Fittings 室內裝置

77B Peak Road 山頂道77B號

Item 細項	Description	描述
(a) Doors 門	Door of Carpark to Common Area Solid core timber door with metal cladding and plastic laminate, fitted with timber door frame, architrave, door lockset and door closer.	停車場往公共地方門 實心木門配金屬蓋板及塑料層壓板，裝有木門框、門楣、門鎖及門鼓。
	Carpark Garage door Proprietary steel sectional garage door with silkgrain polyester primer coating. No accessories.	停車場車庫門 鍍鋅聚氨酯塗層鋼板車庫門，不設配件。
	Doors of Carpark Lift Lobby to Carpark and Driveway Solid core timber door with metal cladding and wood veneer, fitted with timber door frame, architrave, door lockset and door closer.	停車場電梯大堂往停車場及車道門 實心木門配金屬蓋板及木皮飾面，裝有木門框、門楣、門鎖及門鼓。
	Doors of Potable and Flushing Water Pump Room, staircase outside Potable and Flushing Water Pump Room and Corridor to Common Area Solid core timber door with plastic laminate finish, fitted with timber door frame, architrave, door lockset and door closer.	食水及沖廁水泵房、食水及沖廁水泵房外樓梯及走廊往公共地方門 實心木門配塑料層壓板，裝有木門框、門楣、門鎖及門鼓。
	Doors of Electrical Room, Ground Floor Restroom, First Floor Bathroom in Family Room, Store Room, Ensuite 1-3, Dressing Room in Ensuite 1, Master Ensuite and Dressing Room Solid core timber door with wood veneer, fitted with timber door frame, architrave, door lockset and door closer.	電錶房、地下洗手間、一樓起居室內浴室、儲物室、套房1-3、套房1內衣帽間、主人套房及衣帽間門 實心木門配木皮飾面，裝有木門框、門楣、門鎖及門鼓。
	Door of Living Room to Staircase Solid core timber door with wood veneer, fitted with timber door frame, architrave and door closer.	客廳往樓梯門 實心木門配木皮飾面，裝有木門框、門楣及門鼓。
	Doors of Bathroom 1-3 and Master Bathroom Solid core timber door with wood veneer, white lacquered paint finish, mirror and metal trim, fitted with timber door frame, architrave, door lockset and door closer.	浴室1-3及主人浴室門 實心木門配木皮飾面、漆油、鏡及金屬裝飾，裝有木門框、門楣、門鎖及門鼓。
	Kitchen door Solid core timber door with wood veneer and high gloss lacquered finish, fitted with timber door frame, architrave, door lockset and door closer.	廚房門 實心木門配木皮飾面及高光漆油，裝有木門框、門楣、門鎖及門鼓。
	Doors of First Floor Foyer to Family Room Solid core timber sliding door with wood veneer, fitted with timber door frame, architrave and door lockset.	一樓前廳往起居室門 實心木趟門配木皮飾面，裝有木門框、門楣及門鎖。
	Doors of Living Room to Garden and Master Ensuite to Flat Roof Glazed sliding door with aluminum frame, fitted with door lockset.	客廳往花園及主人套房往平台門 鋁框玻璃趟門，裝有門鎖。
	Doors of staircase half-landing and Family Room to Garden Glazed door with aluminum frame, fitted with door lockset.	半落地樓梯及起居室往花園門 鋁框玻璃門，裝有門鎖。
Door of Common Area to open staircase to Garden Metal door with metal cladding, fitted with door lockset.	公共地方往通往花園之露天樓梯門 金屬門配金屬蓋板，裝有門鎖。	

3. Interior Fittings 室內裝置

77B Peak Road 山頂道77B號

Item 細項	Description	描述
(b) Bathroom 浴室	<p>Bathroom 1</p> <p>Fitted with natural stone countertop and sanitary wares and fittings include electroplated wash basin mixer, electroplated bath mixer and shower set, electroplated head shower, ceramic wash basin, enameled steel bathtub (1700mm (L) x 800mm (W) x 420mm (D)), ceramic water closet, electroplated towel bar, electroplated paper holder and wooden cabinet.</p> <p>For type and material of water supply system, please refer to "Water Supply" below.</p>	<p>浴室1</p> <p>裝設天然石材檯面配以衛浴潔具及配件，包括電鍍洗手盆水龍頭、電鍍浴缸水龍頭及花灑套裝、電鍍頂部花灑、陶瓷洗手盆、搪瓷鋼浴缸(1700毫米(長) x 800毫米(寬) x 420毫米(深))、陶瓷坐廁、電鍍毛巾架、電鍍廁紙架及木櫃。</p> <p>供水系統的類型及用料見下文「供水」一欄。</p>
	<p>Bathroom 2</p> <p>Fitted with natural stone countertop and sanitary wares and fittings include electroplated wash basin mixer, electroplated shower set, ceramic wash basin, electroplated head shower, shower cubicle with glass door and metal handle, ceramic water closet, electroplated towel bar, electroplated paper holder and wooden cabinet.</p> <p>For type and material of water supply system, please refer to "Water Supply" below.</p>	<p>浴室2</p> <p>裝設天然石材檯面配以衛浴潔具及配件，包括電鍍洗手盆水龍頭、電鍍花灑套裝、陶瓷洗手盆、電鍍頂部花灑、淋浴間設玻璃門及金屬手柄、陶瓷坐廁、電鍍毛巾架、電鍍廁紙架及木櫃。</p> <p>供水系統的類型及用料見下文「供水」一欄。</p>
	<p>Bathroom 3</p> <p>Fitted with natural stone countertop and sanitary wares and fittings include electroplated wash basin mixer, electroplated shower set, ceramic wash basin, electroplated head shower, shower cubicle with glass door and metal handle, ceramic water closet, electroplated towel bar, electroplated paper holder and wooden cabinet.</p> <p>For type and material of water supply system, please refer to "Water Supply" below.</p>	<p>浴室3</p> <p>裝設天然石材檯面配以衛浴潔具及配件，包括電鍍洗手盆水龍頭、電鍍花灑套裝、陶瓷洗手盆、電鍍頂部花灑、淋浴間設玻璃門及金屬手柄、陶瓷坐廁、電鍍毛巾架、電鍍廁紙架及木櫃。</p> <p>供水系統的類型及用料見下文「供水」一欄。</p>
	<p>Master Bathroom</p> <p>Fitted with natural stone countertop and sanitary wares and fittings include electroplated wash basin mixer, electroplated bath mixer and shower set, electroplated head shower, ceramic wash basin, cast iron bathtub (1822mm (L) x 914mm (W) x 530mm (D)), shower cubicle and wc cubicle with glass door and metal handle, ceramic water closet, electroplated towel bar, electroplated towel warmer, electroplated paper holder and wooden cabinet.</p> <p>For type and material of water supply system, please refer to "Water Supply" below.</p>	<p>主人浴室</p> <p>裝設天然石材檯面配以衛浴潔具及配件，包括電鍍洗手盆水龍頭、電鍍浴缸水龍頭及花灑套裝、電鍍頂部花灑、陶瓷洗手盆、鑄鐵浴缸(1822毫米(長) x 914毫米(寬) x 530毫米(深))、淋浴間及坐廁間配玻璃浴屏及金屬手柄、陶瓷坐廁、電鍍毛巾架、電鍍毛巾暖架、電鍍廁紙架及木櫃。</p> <p>供水系統的類型及用料見下文「供水」一欄。</p>
	<p>First Floor Bathroom in Family Room</p> <p>Fitted with sanitary wares and fittings include electroplated wash basin mixer, electroplated shower set, ceramic wash basin, ceramic water closet.</p> <p>For type and material of water supply system, please refer to "Water Supply" below.</p> <p>Sprinkler heads are installed.</p>	<p>一樓起居室浴室</p> <p>裝設衛浴潔具及配件，包括電鍍洗手盆水龍頭、電鍍花灑套裝、陶瓷洗手盆、陶瓷坐廁。</p> <p>供水系統的類型及用料見下文「供水」一欄。</p> <p>設有消防花灑頭。</p>

3. Interior Fittings 室內裝置

77B Peak Road 山頂道77B號

Item 細項	Description	描述
(c) Kitchen 廚房	Fitted with wooden cabinet with high gloss lacquered finish door panel, stainless steel sink with electroplated sink mixer. For material of water supply system, please refer to "Water Supply" below. For appliances provision, please refer to "Appliance Schedule".	裝設木製廚櫃配高光漆門板、不銹鋼洗滌盆配以電鍍洗滌盆水龍頭。 供水系統的用料見下文「供水」一欄。 設備詳情請參考「設備說明表」。
(d) Bedroom 睡房	Not Applicable.	不適用。
(e) Telephone 電話	Telephone connection points are provided. For the number and the location of connection points, please refer to the "Schedule of Mechanical and Electrical Provisions".	設有電話接駁點。 有關接駁點之數目及位置，請參考「機電裝置數量說明表」。
(f) Aerials 天線	Communal TV and FM connection points are provided. For the number and location of connection points, please refer to the "Schedule of Mechanical and Electrical Provisions".	設有公共電視及FM電台接駁點。 有關接駁點之數目及位置，請參考「機電裝置數量說明表」。
(g) Electrical installations 電力裝置	Three phase electricity supply with miniature circuit breakers distribution boards complete with residual current protection is provided for individual houses. For the number and location of power points and air-conditioner points, please refer to the "Schedule of Mechanical and Electrical Provisions".	每座獨立屋均提供三相電力供電並備有配電箱及微型斷路器及包括漏電保護。 有關電插座及空調機接駁點之數目及位置，請參考「機電裝置數量說明表」。
(h) Gas supply 氣體供應	Town Gas point is provided in Kitchen, gas hob to be installed by purchaser.	廚房內設有煤氣喉接駁點，煤氣爐由買家安裝。
(i) Washing machine connection point 洗衣機接駁點	Washer dryer connection point is located in the Kitchen. Water point of a design of 22mm in diameter and drain point of a design of 40mm in diameter are provided.	洗衣乾衣機接駁點位於廚房。設有洗衣機來水接駁喉位 (其設計為直徑22毫米) 及去水接駁喉 (其設計為直徑40毫米)。
(j) Water supply 供水	PVC-coated copper pipes are provided for both hot and cold water supply. Water pipes are concealed in part and exposed in part. Exposed water pipes are enclosed by false ceiling or bulkhead. Hot water is available.	冷熱水喉管全部採用有膠層保護之銅喉。水管部份是隱藏、部份是外露的，外露的水管由假天花或假陣所圍封。有熱水供應。

3. Interior Fittings 室內裝置

77C Peak Road 山頂道77C號

Item 細項	Description	描述
(a) Doors 門	Carpark Garage door Proprietary steel sectional garage door with silkgrain polyester primer coating. No accessories.	停車場車庫門 鍍鋅聚氨酯塗層鋼板車庫門，不設配件。
	Door of Carpark Lift Lobby to Carpark Solid core timber door with high gloss lacquered wood veneer and metal cladding, fitted with timber door frame, architrave, door lockset and door closer.	停車場電梯大堂往停車場門 實心木門配高光漆木皮飾面及金屬蓋板，裝有木門框、門楣、門鎖及門鼓。
	Door of Carpark to Common Area, Carpark to Corridor outside A/C Plant Room, Electrical Room and Corridor to Potable Water Pump Room Solid core timber door with metal cladding and plastic laminate, fitted with timber door frame, architrave, door lockset and door closer.	停車場往公共地方、停車場往空調機房外走廊、電錶房及走廊門往食水泵房 實心木門配金屬蓋板及塑料層壓板，裝有木門框、門楣、門鎖及門鼓。
	Door of Carpark Lift Lobby to Driveway Solid core timber door with paint, fitted with timber door frame, door lockset and door closer.	停車場電梯大堂往車道門 實心木門配漆油，裝有木門框、門鎖及門鼓。
	Doors of A/C Plant Room, Flushing Water Pump Room, Filtration Plant Room, Common Area to corridor of Filtration Plant Room, Potable Water Pump Room and F.S. and Sprinkler Water Pump Room Solid core timber door with plastic laminate, fitted with timber door frame, architrave, door lockset and door closer.	空調機房、沖廁水泵房、泳池濾水泵房、公共地方往泳池濾水泵房及消防泵及消防花灑水泵房門外走廊門 實心木門配塑料層壓板，裝有木門框、門楣、門鎖及門鼓。
	Door of Common Staircase to Garden Metal door with metal cladding, fitted with door lockset.	公共樓梯往花園門 金屬門配金屬蓋板，裝有門鎖。
	Doors of Dining Room to Yard Glazed doors with aluminum frame, fitted with door lockset.	飯廳往庭院門 鋁框玻璃門，裝有門鎖。
	Doors of Living Room to Garden, Master Ensuite to Balcony Glazed sliding doors with aluminum frame, fitted with door lockset.	客廳往花園及主人套房往露台門 鋁框玻璃趟門，裝有門鎖。
	Dining Room Sliding Doors Solid core timber sliding doors, with emulsion paint, fitted with timber door frame and architrave.	客廳趟門 實心木趟門配乳膠漆，裝有木門框及門楣。
	Doors of Ensuite 1-3 Solid core timber door with high gloss lacquered wood veneer and emulsion paint, fitted with timber door frame, architrave, door lockset and door closer.	套房1-3門 實心木門配高光漆木皮飾面及乳膠漆，裝有木門框、門楣、門鎖及門鼓。
Door of First Floor Restroom to Ensuite 1 Solid core timber door with emulsion paint, fitted with timber door frame, architrave, door lockset and door closer.	一樓洗手間往套房1門 實心木門配乳膠漆，裝有木門框、門楣、門鎖及門鼓。	

3. Interior Fittings 室內裝置

77C Peak Road 山頂道77C號

Item 細項	Description	描述
(a) Doors 門	Door of First Floor Restroom Solid core timber door with emulsion paint, fitted with timber door frame, architrave, door lockset and door closer.	一樓洗手間門 實心木門配乳膠漆，裝有木門框、門楣、門鎖及門鼓。
	Doors of Bathroom 1-3 Solid core timber door with emulsion paint, mirror panel and metal trim, fitted with timber door frame, architrave, door lockset and door closer.	浴室1-3門 實心木門配乳膠漆、鏡面及金屬裝飾、裝有木門框、門楣、門鎖及門鼓。
	Door of Ground Floor Restroom Solid core timber door with emulsion paint, mirror panels and metal trim, fitted with timber door frame, architrave, door lockset and door closer.	地下休息室門 實心木門配乳膠漆、鏡面及金屬裝飾、裝有木門框、門楣、門鎖及門鼓。
	Doors of Living Room to Staircase and Kitchen Solid core timber door with emulsion paint and wall covering, fitted with timber door frame, architrave and door closer.	客廳往樓梯門及廚房門 實心木門配乳膠漆及牆紙、裝有木門框、門楣及門鼓。
	Doors of 2/F Dressing Room Solid core timber door with high gloss lacquered wood veneer and emulsion paint, fitted with timber door frame, architrave, door lockset and door closer.	二樓衣帽間門 實心木門配高光漆木皮飾面及乳膠漆、裝有木門框、門楣、門鎖及門鼓。
	Doors of Master Ensuite to 2/F Dressing Room Solid core timber door with emulsion paint, fitted with timber door frame, architrave, door lockset and door closer.	主人套房往二樓衣帽間門 實心木門配乳膠漆、裝有木門框、門楣、門鎖及門鼓。
	Doors of Master Bathroom Solid core timber door with emulsion paint, mirror panel and metal trim, fitted with timber door frame, architrave, door lockset and door closer.	主人浴室門 實心木門配乳膠漆、鏡面及金屬裝飾、裝有木門框、門楣、門鎖及門鼓。
	Door of Ensuite 1 to Pantry Solid core timber with emulsion paint, fitted with timber door frame, architrave, door lockset and door closer.	套房1往茶水間門 實心木門配乳膠漆、裝有木門框、門楣、門鎖及門鼓。

3. Interior Fittings 室內裝置

77C Peak Road 山頂道77C號

Item 細項	Description	描述
(b) Bathroom 浴室	<p>Bathroom 1</p> <p>Fitted with natural stone countertop and sanitary wares and fittings include electroplated wash basin mixer, electroplated bath mixer and shower set, electroplated head shower, ceramic wash basin, enameled steel bathtub (1700mm (L) x 800mm (W) x 420mm (H)), ceramic water closet, electroplated towel bar, electroplated robe hook, electroplated paper holder and wooden cabinet.</p> <p>For type and material of water supply system, please refer to "Water Supply" below.</p>	<p>浴室1</p> <p>裝設天然石材檯面配以衛浴潔具及配件，包括電鍍洗手盆水龍頭、電鍍浴缸水龍頭和花灑套裝、電鍍頂部花灑、陶瓷洗手盆、搪瓷鋼浴缸(1700毫米(長) x 800毫米(寬) x 420毫米(深))、陶瓷坐廁、電鍍毛巾架、電鍍掛鉤、電鍍廁紙架及木櫃。</p> <p>供水系統的類型及用料見下文「供水」一欄。</p>
	<p>Bathroom 2</p> <p>Fitted with natural stone countertop and sanitary wares and fittings include electroplated wash basin mixer, electroplated shower set, ceramic wash basin, shower cubicle with glass door and metal handle, ceramic water closet, electroplated towel bar, electroplated robe hook, electroplated paper holder and wooden cabinet.</p> <p>For type and material of water supply system, please refer to "Water Supply" below.</p>	<p>浴室2</p> <p>裝設天然石材檯面配以衛浴潔具及配件，包括電鍍洗手盆水龍頭、電鍍花灑套裝、陶瓷洗手盆、淋浴間設玻璃門及金屬手柄、陶瓷坐廁、電鍍毛巾架、電鍍掛鉤、電鍍廁紙架及木櫃。</p> <p>供水系統的類型及用料見下文「供水」一欄。</p>
	<p>Bathroom 3</p> <p>Fitted with natural stone countertop and sanitary wares and fittings include electroplated wash basin mixer, electroplated shower set, ceramic wash basin, shower cubicle with glass door and metal handle, ceramic water closet, electroplated towel bar, electroplated robe hook, electroplated paper holder and wooden cabinet.</p> <p>For type and material of water supply system, please refer to "Water Supply" below.</p>	<p>浴室3</p> <p>裝設天然石材檯面配以衛浴潔具及配件，包括電鍍洗手盆水龍頭、電鍍花灑套裝、陶瓷洗手盆、淋浴間設玻璃門及金屬手柄、陶瓷坐廁、電鍍毛巾架、電鍍掛鉤、電鍍廁紙架及木櫃。</p> <p>供水系統的類型及用料見下文「供水」一欄。</p>
	<p>Master Bathroom</p> <p>Fitted with natural stone countertop and sanitary wares and fittings include electroplated wash basin mixer, electroplated bath mixer and shower set, electroplated head shower, ceramic wash basin, cast iron bathtub (1829mm (L) x 914mm (W) x 524mm (H)), shower cubicle and wc cubicle with glass door and metal handle, ceramic water closet, electroplated towel warmer bar, electroplated tower bar, electroplated robe hook, electroplated paper holder and wooden cabinet.</p> <p>For type and material of water supply system, please refer to "Water Supply" below.</p>	<p>主人浴室</p> <p>裝設天然石材檯面配以衛浴潔具及配件，包括電鍍洗手盆水龍頭、電鍍浴缸水龍頭和花灑套裝、電鍍頂部花灑、陶瓷洗手盆、生鐵浴缸(1829毫米(長) x 914毫米(寬) x 524毫米(深))、淋浴間及坐廁間配玻璃浴屏及金屬手柄、陶瓷坐廁、電鍍暖毛巾架、電鍍掛鉤、電鍍廁紙架及木櫃。</p> <p>供水系統的類型及用料見下文「供水」一欄。</p>
	<p>First Floor Restroom</p> <p>Fitted with sanitary wares and fittings include electroplated wash basin mixer, electroplated shower set, ceramic wash basin, ceramic water closet.</p> <p>For type and material of water supply system, please refer to "Water Supply" below.</p>	<p>一樓洗手間</p> <p>裝設衛浴潔具及配件，包括電鍍洗手盆水龍頭、電鍍花灑套裝、陶瓷面盆、陶瓷坐廁。</p> <p>供水系統的類型及用料見下文「供水」一欄。</p>

3. Interior Fittings 室內裝置

77C Peak Road 山頂道77C號

Item 細項	Description	描述
(c) Kitchen 廚房	Fitted with wooden cabinet with wood veneered finish door panel, stainless steel sink with electroplated sink mixer. For material of water supply system, please refer to "Water Supply" below. For appliances provision, please refer to "Appliance Schedule".	裝設木製廚櫃配木皮飾面門板、不銹鋼洗滌盆配以電鍍洗滌盆水龍頭。 供水系統的類型及用料見下文「供水」一欄。 設備詳情請參考「設備說明表」。
(d) Bedroom 睡房	Not applicable.	不適用。
(e) Telephone 電話	Telephone connection points are provided. For the number and the location of connection points, please refer to the "Schedule of Mechanical and Electrical Provisions".	設有電話接駁點。 有關接駁點之數目及位置，請參考「機電裝置數量說明表」。
(f) Aerials 天線	Communal TV and FM connection points are provided. For the number and location of connection points, please refer to the "Schedule of Mechanical and Electrical Provisions".	設有公共電視及FM電台接駁點。 有關接駁點之數目及位置，請參考「機電裝置數量說明表」。
(g) Electrical installations 電力裝置	Three phase electricity supply with miniature circuit breakers distribution boards complete with residual current protection is provided for individual houses. For the number and location of power points and air-conditioner points, please refer to the "Schedule of Mechanical and Electrical Provisions".	每座獨立屋均提供三相電力供電並備有配電箱及微型斷路器及包括漏電保護。 有關電插座及空調機接駁點之數目及位置，請參考「機電裝置數量說明表」。
(h) Gas supply 氣體供應	Town Gas point is provided in Kitchen, gas hob to be installed by purchaser.	廚房內設有煤氣喉接駁點，煤氣爐由買家安裝。
(i) Washing machine connection point 洗衣機接駁點	Washer dryer connection point is located in the Kitchen. Water point of a design of 22mm in diameter and drain point of a design of 40mm in diameter are provided.	洗衣乾衣機接駁點位於廚房。設有洗衣機來水接駁喉位 (其設計為直徑22毫米) 及去水接駁喉 (其設計為直徑40毫米)。
(j) Water supply 供水	PVC-coated copper pipes are provided for both hot and cold water supply. Water pipes are concealed in part and exposed in part. Exposed water pipes are enclosed by false ceiling or bulkhead. Hot water is available.	冷熱水喉管全部採用有膠層保護之銅喉。水管部份是隱藏、部份是外露的，外露的水管由假天花或假陣所圍封。有熱水供應。

3. Interior Fittings 室內裝置

77D Peak Road 山頂道77D號

Item 細項	Description	描述
(a) Doors 門	Carpark Garage door Proprietary steel sectional garage door with silkgrain polyester primer coating. No accessories.	停車場車庫門 鍍鋅聚氨酯塗層鋼板車庫門，不設配件。
	Door of Carpark Lift Lobby to Carpark and Driveway Solid core timber door with metal cladding and wood veneer, fitted with timber door frame, architrave, door lockset and door closer.	停車場電梯大堂往停車場及車道門 實心木門配金屬蓋板及木皮飾面，裝有木門框、門楣、門鎖及門鼓。
	Doors of A/C Plant Room, Filtration Plant Room, Potable and Flushing Water Pump Room and F.S. and Sprinkler Water Pump Room Solid core timber door with plastic laminate finish, fitted with timber door frame, architrave, door lockset and door closer.	空調機房、泳池濾水泵房、食水及沖廁水泵房及消防泵及消防花灑水泵房門 實心木門配塑料層壓板，裝有木門框、門楣、門鎖及門鼓。
	Doors of Ensuite 1-3, Bathroom 1-3, Master Bathroom, Ground Floor Bathroom, Kitchen, Store Room, Electrical Room, Carpark Lift Lobby to Corridor outside A/C Plant Room and Filtration Plant Room Solid core timber door with wood veneer, fitted with timber door frame, architrave, door lockset and door closer.	套房1-3、浴室1-3、主人浴室、地下浴室、廚房、儲物室、電錶房、停車場電梯大堂往空調機房外走廊及泳池濾水泵房 實心木門配木皮飾面，裝有木門框、門楣、門鎖及門鼓。
	Door of Ground Floor Dining Room to Staircase Solid core timber door with wood veneer, fitted with timber door frame, architrave and door closer.	地下飯廳往樓梯門 實心木門配木皮飾面，裝有木門框、門楣及門鼓。
	Door of Common Area to open staircase Metal door with metal cladding, fitted with door lockset.	公共地方往露天樓梯門 金屬門帶金屬蓋板，裝有門鎖。
	Door of Corridor outside F.S. and Sprinkler Water Pump Room Metal door with paint and metal cladding, fitted with metal door frame, architrave, door lockset and door closer.	消防泵及消防花灑水泵房外走廊門 金屬門配漆油及金屬蓋板，裝有金屬門框、門楣、門鎖及門鼓。
	Door of Carpark to Corridor to Common Area Solid core timber door with metal cladding and plastic laminate, fitted with timber door frame, architrave, door lockset and door closer.	停車場往通往公共地方之走廊門 實心木門配有金屬蓋板及塑料層壓板，裝有木門框、門楣、門鎖及門鼓。
	Door of Second Floor Foyer to Master Ensuite Solid core timber sliding door with wood veneer, fitted with timber door frame and architrave.	二樓前廳往主人套房 實心木趟門配木皮飾面，裝有木門框及門楣。
	Door of Ground Floor Restroom Glazed folding door fitted with aluminum frame, fitted with door lockset.	地下洗手間門 鋁框玻璃折疊門，裝有門鎖。
	Doors of Living Room to Garden and Master Ensuite to Flat Roof Glazed sliding door with aluminum frame, fitted with door lockset.	客廳往花園及主人套房往平台門 鋁框玻璃趟門，裝有門鎖。
	Doors of Dining Room, Kitchen and Bathroom to Yard Glazed door with aluminum frame, fitted with door lockset.	飯廳、廚房及浴室往庭院門 鋁框玻璃門，裝有門鎖。
Door of Corridor outside Potable and Flushing Water Pump Room to Common Area Solid core timble door with plastic laminate and timber veneer, fitted with timber door frame, architrave, door lockset and door closer.	食水及沖廁水泵房外走廊往公共地方門 實心木門配塑料層壓板及木皮飾面，裝有木門框、門楣、門鎖及門鼓。	

3. Interior Fittings 室內裝置

77D Peak Road 山頂道77D號

Item 細項	Description	描述
(b) Bathroom 浴室	<p>Bathroom 1</p> <p>Fitted with natural stone countertop and sanitary wares and fittings include electroplated wash basin mixer, electroplated bath mixer and shower set, electroplated head shower, natural stone wash basin, enameled steel bathtub (1800mm (L) x 800mm (W) x 410mm (D)), ceramic water closet, electroplated towel bar, electroplated paper holder and wooden cabinet.</p> <p>For type and material of water supply system, please refer to "Water Supply" below.</p>	<p>浴室1</p> <p>裝設天然石材檯面配以衛浴潔具及配件，包括電鍍洗手盆水龍頭、電鍍淋浴水龍頭及花灑套裝、電鍍頂部花灑、天然石材面盆、搪瓷鋼浴缸(1800毫米(長) x 800毫米(寬) x 410毫米(深))、陶瓷坐廁、電鍍毛巾架、電鍍廁紙架及木櫃。</p> <p>供水系統的類型及用料見下文「供水」一欄。</p>
	<p>Bathroom 2</p> <p>Fitted with natural stone countertop and sanitary wares and fittings include electroplated wash basin mixer, electroplated shower set, electroplated head shower, natural stone wash basin, shower cubicle with glass door and metal handle, ceramic water closet, electroplated towel bar, electroplated paper holder and wooden cabinet.</p> <p>For type and material of water supply system, please refer to "Water Supply" below.</p>	<p>浴室2</p> <p>裝設天然石材檯面配以衛浴潔具及配件，包括電鍍洗手盆水龍頭、電鍍花灑套裝、電鍍頂部花灑、天然石材面盆、淋浴間設玻璃門及金屬手柄、陶瓷坐廁、電鍍毛巾架、電鍍廁紙架及木櫃。</p> <p>供水系統的類型及用料見下文「供水」一欄。</p>
	<p>Bathroom 3</p> <p>Fitted with natural stone countertop and sanitary wares and fittings include electroplated wash basin mixer, electroplated shower set, electroplated head shower, natural stone wash basin, shower cubicle with glass door and metal handle, ceramic water closet, electroplated towel bar, electroplated paper holder and wooden cabinet.</p> <p>For type and material of water supply system, please refer to "Water Supply" below.</p>	<p>浴室3</p> <p>裝設天然石材檯面配以衛浴潔具及配件，包括電鍍洗手盆水龍頭、電鍍花灑套裝、電鍍頂部花灑、天然石材面盆、淋浴間設玻璃門及金屬手柄、陶瓷坐廁、電鍍毛巾架、電鍍廁紙架及木櫃。</p> <p>供水系統的類型及用料見下文「供水」一欄。</p>
	<p>Master Bathroom</p> <p>Fitted with natural stone countertop and sanitary wares and fittings include electroplated wash basin mixer, electroplated bath mixer and shower set, electroplated head shower, natural stone wash basin, natural stone bathtub (1700mm (L) x 850mm (W) x 510mm (D)), shower cubicle and wc cubicle with glass door and metal handle, electroplated towel bar, electroplated towel warmer, ceramic water closet, electroplated paper holder and wooden cabinet.</p> <p>For type and material of water supply system, please refer to "Water Supply" below.</p>	<p>主人浴室</p> <p>裝設天然石材檯面配以衛浴潔具及配件，包括電鍍洗手盆水龍頭、電鍍浴缸水龍頭及電鍍花灑套裝、電鍍頂部花灑、天然石材面盆、天然石材浴缸(1700毫米(長) x 850毫米(寬) x 510毫米(深))、淋浴間及坐廁間配玻璃浴屏及金屬扶手、電鍍毛巾架、電鍍毛巾暖架、陶瓷坐廁、電鍍廁紙架及木櫃。</p> <p>供水系統的類型及用料見下文「供水」一欄。</p>
	<p>Ground Floor Restroom in Store Room</p> <p>Fitted with sanitary wares and fittings include electroplated wash basin mixer, electroplated shower set, ceramic wash basin, ceramic water closet.</p> <p>For type and material of water supply system, please refer to "Water Supply" below.</p>	<p>地下儲物室洗手間</p> <p>裝設衛浴潔具及配件，包括電鍍洗手盆水龍頭、電鍍花灑套裝、陶瓷洗手盆、陶瓷坐廁。</p> <p>供水系統的類型及用料見下文「供水」一欄。</p>

3. Interior Fittings 室內裝置

77D Peak Road 山頂道77D號

Item 細項	Description	描述
(c) Kitchen 廚房	Fitted with wooden cabinet with wood veneered door panel, stainless steel sink with electroplated sink mixer. For material of water supply system, please refer to "Water Supply" below. For appliances provision, please refer to "Appliance Schedule".	裝設木製廚櫃配木皮飾面門板、不銹鋼洗滌盆配以電鍍洗滌盆水龍頭。 供水系統的用料見下文「供水」一欄。 設備詳情請參考「設備說明表」。
(d) Bedroom 睡房	Not Applicable.	不適用。
(e) Telephone 電話	Telephone connection points are provided. For the number and the location of connection points, please refer to the "Schedule of Mechanical and Electrical Provisions".	設有電話接駁點。 有關接駁點之數目及位置，請參考「機電裝置數量說明表」。
(f) Aerials 天線	Communal TV and FM connection points are provided. For the number and location of connection points, please refer to the "Schedule of Mechanical and Electrical Provisions".	設有公共電視及FM電台接駁點。 有關接駁點之數目及位置，請參考「機電裝置數量說明表」。
(g) Electrical installations 電力裝置	Three phase electricity supply with miniature circuit breakers distribution boards complete with residual current protection is provided for individual houses. All conduits are concealed except those inside or enclosed by block wall, false ceiling, bulkhead, mouldings, cornices and cabinets. For the number and location of power points and air-conditioner points, please refer to the "Schedule of Mechanical and Electrical Provisions".	每座獨立屋均提供三相電力供電並備有配電箱及微型斷路器及包括漏電保護。 所有電線均採用隱藏式電線喉管安裝方法，除部份外露電線喉管藏於磚牆、假天花、假陣、石膏板圍邊、裝飾線及廚櫃內。 有關電插座及空調機接駁點之數目及位置，請參考「機電裝置數量說明表」。
(h) Gas supply 氣體供應	Town gas point is provided in Kitchen and connected to built-in gas cooking hob.	廚房內裝妥煤氣喉接駁內置煤氣煮食爐。
(i) Washing machine connection point 洗衣機接駁點	Washer dryer connection point is located in the Store Room. Water point of a design of 22mm in diameter and drain point of a design of 40mm in diameter are provided.	洗衣乾衣機接駁點位於儲物室。設有洗衣機來水接駁喉位 (其設計為直徑22毫米) 及去水接駁喉 (其設計為直徑40毫米)。
(j) Water supply 供水	PVC-coated copper pipes are provided for both hot and cold water supply. Water pipes are concealed in part and exposed in part. Exposed water pipes are enclosed by false ceiling or bulkhead. Hot water is available.	冷熱水喉管全部採用有膠層保護之銅喉。水管部份是隱藏、部份是外露的，外露的水管由假天花或假陣所圍封。有熱水供應。

3. Interior Fittings 室內裝置

77E Peak Road 山頂道77E號

Item 細項	Description	描述
(a) Doors 門	Main Gate Motorized metal gate. No accessories.	大閘 機動金屬閘，不設配件。
	Carpark Garage door Proprietary steel sectional garage door with wicket door with silkgrain polyester primer coating. No accessories.	停車場車庫門 鍍鋅聚氨酯塗層鋼板車庫門帶有方便門，不設配件。
	Door of Carpark Lift Lobby to Carpark Solid core timber door with wood veneer and metal cladding, fitted with timber door frame, architrave, door lockset and door closer.	停車場電梯大堂往停車場門 實心木門配木皮飾面及金屬蓋板，裝有木門框、門楣、門鎖及門鼓。
	Doors of Filtration Plant Room, Potable and Flushing Water Pump Room, F.S. Pump Room, Electrical Room and Sprinkler Water Pump Room Solid core timber door with plastic laminate, fitted with timber door frame, architrave, door lockset and door closer.	泳池濾水泵房、食水及沖廁水泵房、消防泵房，電錶房及消防花灑水泵房門 實心木門配塑料層壓板，裝有木門框、門楣、門鎖及門鼓。
	Doors of Kitchen and Store Room Solid core timber door with wood veneer and high gloss lacquered finish, fitted with timber door frame, architrave, door lockset and door closer.	廚房及儲物室門 實心木門配木皮飾面及高光漆，裝有木門框、門楣、門鎖及門鼓。
	Doors of staircase to Sprinkler Water Tank, Family Room, Ensuite 1-5, Ensuite 3 Dressing Room, Ensuite 4 Dressing Room, Master Ensuite and Dressing Room Solid core timber door with wood veneer, fitted with timber door frame, architrave, door lockset and door closer.	樓梯往消防花灑水缸、起居室、套房1-5、套房3內衣帽間、套房4內衣帽間、主人套房及衣帽間門 實心木門配木皮飾面，裝有木門框、門楣、門鎖及門鼓。
	Door of Carpark Lift Lobby to Staircase Solid core timber door with wood veneer, fitted with timber door frame, architrave and door closer.	停車場電梯大堂往樓梯門 實心木門配木皮飾面，裝有木門框、門楣及門鼓。
	Doors of Dining Room, Living Room and Ensuite 1 to Garden, Master Ensuite and Ensuite 5 to Flat Roof Glazed sliding door with aluminum frame, fitted with door lockset.	飯廳、客廳及套房1往花園、主人套房及套房5往平台門 鋁框玻璃趟門，裝有門鎖。
	Doors of Carpark to Corridor outside Filtration Plant Room, Potable and Flushing Water Pump Room, F.S. Pump Room, Electrical Room and Sprinkler Water Pump Room Solid core timber door with metal cladding and plastic laminate, fitted with timber door frame, architrave, door lockset and door closer.	停車場往泳池濾水泵房外走廊、食用水及沖廁水泵房、消防泵房、電錶房及消防花灑水泵房門 實心木門配有金屬蓋板及塑料層壓板，裝有木門框、門楣、門鎖及門鼓。
	Door of Common Area to open staircase to Garden Metal door with metal cladding, fitted with door lockset.	公共地方往通往花園之露天樓梯的門 金屬門配金屬蓋板，裝有門鎖。
Doors of Bathroom 1, Bathroom 3, Bathroom 4, Bathroom in Family Room and Master Bathroom Solid core timber door with wood veneer, lacquered paint finish, mirror and metal trim, fitted with timber door frame, architrave, door lockset and door closer.	浴室1、浴室3、浴室4、起居室內浴室及主人浴室門 實心木門配木皮飾面、漆油、鏡及金屬裝飾，裝有木門框、門楣、門鎖及門鼓。	

3. Interior Fittings 室內裝置

77E Peak Road 山頂道77E號

Item 細項	Description	描述
(a) Doors 門	Doors of Bathroom 2 and Bathroom 5 Solid core timber sliding door with wood veneer, lacquered paint finish, mirror and metal trim, fitted with wooden door frame, architrave and door lockset.	浴室2及浴室5門 實心木趟門配木皮飾面、漆油、鏡及金屬裝飾，裝有木門框、門楣及門鎖。
	Door of Restroom in Store Room Glazed door fitted with aluminum frame, fitted with door lockset.	儲物室內洗手間門 鋁框玻璃門，裝有門鎖。
	Door of Corridor outside Sprinkler Water Pump Room to Common staircase Metal door with metal cladding, fitted with metal door frame, architrave, door lockset and door closer.	消防花灑水泵房外走廊往公共樓梯門 金屬門配金屬蓋板，裝有金屬門框、門楣、門鎖及門鼓。
	Door of A/C Plant Room Metal door with paint and metal cladding, fitted with metal door frame, architrave, door lockset and door closer.	空調機房門 金屬門配漆油及金屬飾面，裝有金屬門框、門楣、門鎖及門鼓。
	Doors of Carpark to Garden, Kitchen to Yard, Family Room to Garden and staircase half-landing at Roof Glazed doors with aluminum frame, fitted with door lockset.	停車場往花園、廚房往庭院、起居室往花園及天台半落地樓梯門 鋁框玻璃門，裝有門鎖。
(b) Bathroom 浴室	Bathroom 1 Fitted with natural stone countertop and sanitary wares and fittings include electroplated wash basin mixer, electroplated bath mixer and shower set, electroplated head shower, ceramic wash basin, enameled steel bathtub (1800mm (L) x 800mm (W) x 410mm (D)), ceramic water closet, electroplated towel bar, electroplated paper holder and wooden cabinet. For type and material of water supply system, please refer to "Water Supply" below.	浴室1 裝設天然石材檯面配以衛浴潔具及配件，包括電鍍洗手盆水龍頭、電鍍浴缸水龍頭及花灑套裝、電鍍頂部花灑、陶瓷洗手盆、搪瓷鋼浴缸(1800毫米(長) x 800毫米(寬) x 410毫米(深))、陶瓷坐廁、電鍍毛巾架、電鍍廁紙架及木櫃。 供水系統的類型及用料見下文「供水」一欄。
	Bathroom 2 Fitted with natural stone countertop and sanitary wares and fittings include electroplated wash basin mixer, electroplated bath mixer and shower set, electroplated head shower, ceramic wash basin, enameled steel bathtub (1800mm (L) x 800mm (W) x 410mm (D)), ceramic water closet, electroplated towel bar, electroplated paper holder and wooden cabinet. For type and material of water supply system, please refer to "Water Supply" below.	浴室2 裝設天然石材檯面配以衛浴潔具及配件，包括電鍍洗手盆水龍頭、電鍍浴缸水龍頭及花灑套裝、電鍍頂部花灑、陶瓷洗手盆、搪瓷鋼浴缸(1800毫米(長) x 800毫米(寬) x 410毫米(深))、陶瓷坐廁、電鍍毛巾架、電鍍廁紙架及木櫃。 供水系統的類型及用料見下文「供水」一欄。
	Bathroom 3 Fitted with natural stone countertop and sanitary wares and fittings include electroplated wash basin mixer, electroplated shower set, electroplated head shower, ceramic wash basin, shower cubicle with glass door and metal handle, ceramic water closet, electroplated towel bar, electroplated paper holder and wooden cabinet. For type and material of water supply system, please refer to "Water Supply" below.	浴室3 裝設天然石材檯面配以衛浴潔具及配件，包括電鍍洗手盆水龍頭、電鍍淋浴間花灑套裝、電鍍頂部花灑、陶瓷洗手盆、淋浴間設玻璃門及金屬手柄、陶瓷坐廁、電鍍毛巾架、電鍍廁紙架及木櫃。 供水系統的類型及用料見下文「供水」一欄。

3. Interior Fittings 室內裝置

77E Peak Road 山頂道77E號

Item 細項	Description	描述
(b) Bathroom 浴室	<p>Bathroom 4</p> <p>Fitted with natural stone countertop and sanitary wares and fittings include electroplated wash basin mixer, electroplated shower set, electroplated head shower, ceramic wash basin, shower cubicle with glass door and metal handle, ceramic water closet, electroplated towel bar, electroplated paper holder and wooden cabinet.</p> <p>For type and material of water supply system, please refer to "Water Supply" below.</p>	<p>浴室4</p> <p>裝設天然石材檯面配以衛浴潔具及配件，包括電鍍洗手盆水龍頭、電鍍花灑套裝、電鍍頂部花灑、陶瓷洗手盆、淋浴間設玻璃門及金屬手柄、陶瓷坐廁、電鍍毛巾架、電鍍廁紙架及木櫃。</p> <p>供水系統的類型及用料見下文「供水」一欄。</p>
	<p>Bathroom 5</p> <p>Fitted with natural stone countertop and sanitary wares and fittings include electroplated wash basin mixer, electroplated bath mixer and shower set, electroplated head shower, ceramic wash basin, enameled steel bathtub (1800mm (L) x 800mm (W) x 410mm (D)), ceramic water closet, electroplated towel bar, electroplated paper holder and wooden cabinet.</p> <p>For type and material of water supply system, please refer to "Water Supply" below.</p>	<p>浴室5</p> <p>裝設天然石材檯面配以衛浴潔具及配件，包括電鍍洗手盆水龍頭、電鍍浴缸水龍頭及花灑套裝、電鍍頂部花灑、陶瓷洗手盆、搪瓷鋼浴缸(1800毫米(長) x 800毫米(寬) x 410毫米(深))、陶瓷坐廁、電鍍毛巾架、電鍍廁紙架及木櫃。</p> <p>供水系統的類型及用料見下文「供水」一欄。</p>
	<p>Master Bathroom</p> <p>Fitted with natural stone countertop and sanitary wares and fittings include electroplated wash basin mixer, electroplated bath mixer and shower set, ceramic wash basin, electroplated head shower, enamelled steel bathtub (1800mm (L) x 800mm (W) x 410mm (D)), shower cubicle and WC cubicle with glass door and metal handle, ceramic water closet, electroplated towel bar, electroplated towel warmer, electroplated paper holder and wooden cabinet.</p> <p>For type and material of water supply system, please refer to "Water Supply" below.</p>	<p>主人浴室</p> <p>裝設天然石材檯面配以衛浴潔具及配件，包括電鍍洗手盆水龍頭、電鍍浴缸水龍頭及花灑套裝、陶瓷洗手盆、電鍍頂部花灑、搪瓷鋼浴缸(1800毫米(長) x 800毫米(寬) x 410毫米(深))、淋浴間及坐廁間配玻璃浴屏及金屬手柄、陶瓷坐廁、電鍍毛巾架、電鍍手柄暖架、電鍍廁紙架及木櫃。</p> <p>供水系統的類型及用料見下文「供水」一欄。</p>
	<p>Ground Floor Restroom in Store Room</p> <p>Fitted with sanitary wares and fittings include electroplated wash basin mixer, electroplated shower set, ceramic wash basin, ceramic water closet.</p> <p>For type and material of water supply system, please refer to "Water Supply" below.</p>	<p>地下儲物室洗手間</p> <p>裝設衛浴潔具及配件，包括電鍍洗手盆水龍頭及電鍍花灑套裝、陶瓷洗手盆、陶瓷坐廁。</p> <p>供水系統的類型及用料見下文「供水」一欄。</p>
	<p>Bathroom in Family Room</p> <p>Fitted with natural stone countertop and sanitary wares and fittings include electroplated wash basin mixer, electroplated shower set, ceramic wash basin, electroplated head shower, shower cubicle with glass door and metal handle, ceramic water closet, electroplated paper holder and wooden cabinet.</p> <p>For type and material of water supply system, please refer to "Water Supply" below.</p> <p>Sprinkler heads are installed.</p>	<p>起居室浴室</p> <p>裝設天然石材檯面配以衛浴潔具及配件，包括電鍍洗手盆水龍頭、電鍍花灑套裝、陶瓷洗手盆、電鍍頂部花灑、淋浴間設玻璃門及金屬手柄、陶瓷坐廁、電鍍廁紙架及木櫃。</p> <p>供水系統的類型及用料見下文「供水」一欄。</p> <p>設有消防花灑頭。</p>

3. Interior Fittings 室內裝置

77E Peak Road 山頂道77E號

Item 細項	Description	描述
(c) Kitchen 廚房	Fitted with wooden cabinet with high gloss lacquered finish door panel, stainless steel sink with electroplated sink mixer. For material of water supply system, please refer to "Water Supply" below. For appliances provision, please refer to "Appliance Schedule".	裝設木製廚櫃配高光漆門板、不銹鋼洗滌盆配以電鍍洗滌盆水龍頭。 供水系統的用料見下文「供水」一欄。 設備詳情請參考「設備說明表」。
(d) Bedroom 睡房	Not Applicable.	不適用。
(e) Telephone 電話	Telephone connection points are provided. For the number and the location of connection points, please refer to the "Schedule of Mechanical and Electrical Provisions".	設有電話接駁點。 有關接駁點之數目及位置，請參考「機電裝置數量說明表」。
(f) Aerials 天線	Communal TV and FM connection points are provided. For the number and location of connection points, please refer to the "Schedule of Mechanical and Electrical Provisions".	設有公共電視及FM電台接駁點。 有關接駁點之數目及位置，請參考「機電裝置數量說明表」。
(g) Electrical installations 電力裝置	Three phase electricity supply with miniature circuit breakers distribution boards complete with residual current protection is provided for individual houses. For the number and location of power points and air-conditioner points, please refer to the "Schedule of Mechanical and Electrical Provisions".	每座獨立屋均提供三相電力供電並備有配電箱及微型斷路器及包括漏電保護。 有關電插座及空調機接駁點之數目及位置，請參考「機電裝置數量說明表」。
(h) Gas supply 氣體供應	Town Gas point is provided in Kitchen, gas hob to be installed by purchaser.	廚房內設有煤氣喉接駁點，煤氣爐由買家安裝。
(i) Washing machine connection point 洗衣機接駁點	Washer dryer connection point is located in the Kitchen. Water point of a design of 22mm in diameter and drain point of a design of 40mm in diameter are provided.	洗衣乾衣機接駁點位於廚房。設有洗衣機來水接駁喉位 (其設計為直徑22毫米) 及去水接駁喉 (其設計為直徑40毫米)。
(j) Water supply 供水	PVC-coated copper pipes are provided for both hot and cold water supply. Water pipes are concealed in part and exposed in part. Exposed water pipes are enclosed by false ceiling or bulkhead. Hot water is available.	冷熱水喉管全部採用有膠層保護之銅喉。水管部份是隱藏、部份是外露的，外露的水管由假天花或假陣所圍封。有熱水供應。

3. Interior Fittings 室內裝置

77F Peak Road 山頂道77F號

Item 細項	Description	描述
(a) Doors 門	Main Gate Motorized metal gate. No accessories.	大閘 機動金屬閘，不設配件。
	Main Entry door and door of Carpark Lift Lobby to Carpark Solid core timber door with wood veneer and metal cladding, fitted with timber door frame, architrave, door lockset and door closer.	停車場入口大門及停車場電梯大堂往停車場大門 實心木門配木皮飾面及金屬蓋板，裝有木門框、門楣、門鎖及門鼓。
	Carpark Garage door Proprietary steel sectional garage door with silkgrain polyester primer coating. No accessories.	停車場車庫門 鍍鋅聚氨酯塗層鋼板車庫門，不設配件。
	Doors of Filtration Plant Room, Potable and Flushing Water Pump Room, Corridor outside Potable and Flushing Water Pump Room, Filtration Plant and Common Area Solid core timber door with plastic laminate finish, fitted with timber door frame, architrave, door lockset and door closer.	泳池濾水泵房、食水及沖廁水泵房、食水及沖廁水泵房外走廊，泳池濾水泵房及公共地方門 實心木門配塑料層壓板，裝有木門框架、門楣、門鎖及門鼓。
	Doors of Bathroom 1-2 Solid core timber door with wood veneer, lacquered paint finish, mirror and metal trim, fitted with timber door frame, architrave, door lockset and door closer.	浴室1-2門 實心木門配木皮飾面、漆油、鏡及金屬裝飾，裝有木門框、門楣、門鎖及門鼓。
	Doors of Kitchen and Store Room Solid core timber door with wood veneer and high gloss lacquered finish, fitted with timber door frame, architrave, door lockset and door closer.	廚房及儲物室門 實心木門配木皮飾面及高光漆，裝有木門框、門楣、門鎖及門鼓。
	Family Room door Solid core timber sliding door with wood veneer, fitted with timber door frame, architrave and door lockset.	起居室門 實心木趟門配木皮飾面，裝有木門框、門楣及門鎖。
	Doors of Bathroom 3 and Master Bathroom Solid core timber sliding door with wood veneer, lacquered paint finish, mirror and metal trim, fitted with timber door frame, architrave and door lockset.	浴室3及主人浴室門 實心木趟門配木皮飾面、漆油、鏡及金屬裝飾，裝有木門框、門楣及門鎖。
	Door of Restroom in Store Room Glazed door fitted with aluminum frame. No accessories.	儲物室內洗手間門 鋁框玻璃門，不設配件。
	Door of Living Room and Dining Room to Garden Glazed sliding door with aluminium frame, fitted with door lockset.	飯廳及客廳往花園門 鋁框玻璃趟門，裝有門鎖。
	Doors of Ensuite 2 to Garden and Ensuite 1 to Swimming Pool Glazed door with aluminum frame, fitted with door lockset.	套房2往花園及套房1往游泳池門 鋁框玻璃門，裝有門鎖。
	Door of staircase half-landing to Roof Glazed door with aluminum frame, fitted with door lockset.	半落地樓梯往天台門 鋁框玻璃門，裝有門鎖。
	Doors of Electrical Room, A/C Plant Room, Ground Floor Restroom, Ensuite 1-3, all Dressing Rooms and Master Ensuite Solid core timber door with wood veneer, fitted with timber door frame, architrave, door lockset and door closer.	電錶房、空調機機房、地下洗手間、套房1-3、所有衣帽間及主人套房門 實心木門配木皮飾面，裝有木門框、門楣、門鎖及門鼓。
Door of Carpark Lift Lobby to Staircase Solid core timber door with wood veneer, fitted with timber door frame, architrave and door closer.	停車場電梯大堂往樓梯門 實心木門配木皮飾面，裝有木門框、門楣及門鼓。	

3. Interior Fittings 室內裝置

77F Peak Road 山頂道77F號

Item 細項	Description	描述
(a) Doors 門	Door of Carpark Lift Lobby to Driveway Metal door with metal cladding and timber veneer, fitted with metal door frame, architrave, door lockset and door closer.	停車場電梯大堂往車道門 金屬門配金屬蓋板及木皮飾面，裝有金屬門框、門楣、門鎖及門鼓。
	Door of F.S. Water Tank and Door of Carpark to Corridor to Common Area Solid core timber door with metal cladding and plastic laminate, fitted with timber door frame, architrave, door lockset and door closer.	消防水缸及停車場往通往公共地方之走廊的門 實心木門配金屬蓋板及塑料層壓板，裝有木門框、門楣、門鎖及門鼓。
	Door of Common Area to open staircase Metal door with metal cladding, fitted with door lockset.	公共地方往露天樓梯門 金屬門配金屬蓋板，裝有門鎖。
(b) Bathroom 浴室	Bathroom 1 Fitted with natural stone countertop and sanitary wares and fittings include electroplated wash basin mixer, electroplated bath mixer and shower set, electroplated head shower, ceramic wash basin, enameled steel bathtub (1700mm (L) x 800mm (W) x 420mm (D)), ceramic water closet, electroplated towel bar, electroplated paper holder and wooden cabinet. For type and material of water supply system, please refer to "Water Supply" below.	浴室1 裝設天然石材檯面配以衛浴潔具及配件，包括電鍍洗手盆水龍頭、電鍍淋浴水龍頭及花灑套裝、電鍍頂部花灑、陶瓷洗手盆、搪瓷鋼浴缸(1700毫米(長) x 800毫米(寬) x 420毫米(深))、陶瓷坐廁、電鍍毛巾架、電鍍廁紙架及木櫃。 供水系統的類型及用料見下文「供水」一欄。
	Bathroom 2 Fitted with natural stone countertop and sanitary wares and fittings include electroplated wash basin mixer, electroplated shower set, electroplated head shower, ceramic wash basin, shower cubicle with glass door and metal handle, ceramic water closet, electroplated towel bar, electroplated paper holder and wooden cabinet. For type and material of water supply system, please refer to "Water Supply" below.	浴室2 裝設天然石材檯面配以衛浴潔具及配件，包括電鍍洗手盆水龍頭、電鍍花灑套裝、電鍍頂部花灑、陶瓷洗手盆、淋浴間設玻璃門及金屬手柄、陶瓷坐廁、電鍍毛巾架、電鍍廁紙架及木櫃。 供水系統的類型及用料見下文「供水」一欄。
	Bathroom 3 Fitted with natural stone countertop and sanitary wares and fittings include electroplated wash basin mixer, electroplated bath mixer and shower set, electroplated head shower, ceramic wash basin, enameled steel bathtub (1800mm (L) x 800mm (W) x 410mm (D)), ceramic water closet, electroplated towel bar, electroplated paper holder and wooden cabinet. For type and material of water supply system, please refer to "Water Supply" below.	浴室3 裝設天然石材檯面配以衛浴潔具及配件，包括電鍍洗手盆水龍頭、電鍍淋浴水龍頭及花灑套裝、電鍍頂部花灑、陶瓷洗手盆、搪瓷鋼浴缸(1800毫米(長) x 800毫米(寬) x 410毫米(深))、陶瓷坐廁、電鍍毛巾架、電鍍廁紙架及木櫃。 供水系統的類型及用料見下文「供水」一欄。
	Master Bathroom Fitted with natural stone countertop and sanitary wares and fittings include electroplated wash basin mixer, electroplated bath mixer and shower set, electroplated head shower, ceramic wash basin, cast iron bathtub (1822mm (L) x 914mm (W) x 530mm (D)), shower cubicle and WC cubicle with glass door and metal handle, ceramic water closet, electroplated towel warmer, electroplated paper holder and wooden cabinet. For type and material of water supply system, please refer to "Water Supply" below.	主人浴室 裝設天然石材檯面配以衛浴潔具及配件，包括電鍍洗手盆水龍頭、電鍍淋浴水龍頭及花灑套裝、電鍍頂部花灑、陶瓷洗手盆、鑄鐵浴缸(1822毫米(長) x 914毫米(寬) x 530毫米(深))、淋浴間及坐廁間配玻璃浴屏及金屬手柄、陶瓷坐廁、電鍍毛巾暖架、電鍍廁紙架及木櫃。 供水系統的類型及用料見下文「供水」一欄。

3. Interior Fittings 室內裝置

77F Peak Road 山頂道77F號

Item 細項	Description	描述
(b) Bathroom 浴室	Restroom in Store Room Fitted with sanitary wares and fittings include electroplated wash basin mixer, electroplated shower set, ceramic wash basin, ceramic water closet. For type and material of water supply system, please refer to "Water Supply" below.	儲物室洗手間 裝設衛浴潔具及配件，包括電鍍洗手盆水龍頭、電鍍花灑套裝、陶瓷洗手盆、陶瓷坐廁。 供水系統的類型及用料見下文「供水」一欄。
(c) Kitchen 廚房	Fitted with wooden cabinet with both gloss lacquered finish door panel, stainless steel sink with electroplated sink mixer. For material of water supply system, please refer to "Water Supply" below. For appliances provision, please refer to "Appliance Schedule".	裝設木製廚櫃配高光漆門板、不銹鋼洗滌盆配以電鍍洗滌盆水龍頭。 供水系統的用料見下文「供水」一欄。 設備詳情請參考「設備說明表」。
(d) Bedroom 睡房	Not Applicable.	不適用。
(e) Telephone 電話	Telephone connection points are provided. For the number and the location of connection points, please refer to the "Schedule of Mechanical and Electrical Provisions".	設有電話接駁點。 有關接駁點之數目及位置，請參考「機電裝置數量說明表」。
(f) Aerials 天線	Communal TV and FM connection points are provided. For the number and location of connection points, please refer to the "Schedule of Mechanical and Electrical Provisions".	設有公共電視及FM電台接駁點。 有關接駁點之數目及位置，請參考「機電裝置數量說明表」。
(g) Electrical installations 電力裝置	Three phase electricity supply with miniature circuit breakers distribution boards complete with residual current protection is provided for individual houses. All conduits are concealed except those inside or enclosed by block wall, false ceiling, bulkhead, mouldings, cornices and cabinets. For the number and location of power points and air-conditioner points, please refer to the "Schedule of Mechanical and Electrical Provisions".	每座獨立屋均提供三相電力供電並備有配電箱及微型斷路器及包括漏電保護。 所有電線均採用隱藏式電線喉管安裝方法，除部份外露電線喉管藏於磚牆、假天花、假陣、石膏板圍邊、裝飾線及廚櫃內。 有關電插座及空調機接駁點之數目及位置，請參考「機電裝置數量說明表」。
(h) Gas supply 氣體供應	Town gas point is provided in Kitchen and connected to built-in gas cooking hob.	廚房內裝妥煤氣喉接駁內置煤氣煮食爐。
(i) Washing machine connection point 洗衣機接駁點	Washer dryer connection point is located in the Kitchen. Water point of a design of 22mm in diameter and drain point of a design of 40mm in diameter are provided.	洗衣乾衣機接駁點位於廚房。設有洗衣機來水接駁喉位 (其設計為直徑22毫米) 及去水接駁喉 (其設計為直徑40毫米)。
(j) Water supply 供水	PVC-coated copper pipes are provided for both hot and cold water supply. Water pipes are concealed in part and exposed in part. Exposed water pipes are enclosed by false ceiling or bulkhead. Hot water is available.	冷熱水喉管全部採用有膠層保護之銅喉。水管部份是隱藏、部份是外露的，外露的水管由假天花或假陣所圍封。有熱水供應。

4. Miscellaneous 雜項

Item 細項	Description	描述
(a) Lifts 升降機	<p>79 Peak Road⁺: One "Schindler" lift (model no.5500MRL). Floors Served - Ground Floor, Upper Ground Floor and First Floor.</p> <p>79A[^], 77A, 77B, 77C, 77D and 77E Peak Road: One "Schindler" lift (model no.5500MRL). Floors Served - Lower Ground Floor, Ground Floor, First Floor and Second Floor.</p> <p>77F Peak Road: One "Schindler" lift (model no.5500MRL). Floors Served - Lower Ground Floor, Ground Floor and First Floor.</p>	<p>山頂道79號⁺： 一部「迅達」電梯 (型號：5500MRL)。 所停層數：地下、地面高層及一樓。</p> <p>山頂道79A[^]、77A、77B、77C、77D及77E號： 一部「迅達」電梯 (型號：5500MRL)。 所停層數：地下低層、地下、一樓及二樓。</p> <p>山頂道77F號： 一部「迅達」電梯 (型號：5500MRL)。 所停層數：地下低層、地下及一樓。</p>
(b) Letter box 信箱	Aluminum letter box.	鋁質信箱。
(c) Refuse collection 垃圾收集	Refuse will be collected by cleaners and centrally handled at refuse storage and material recovery chambers on Lower Ground Floor of the Development.	家居垃圾由清潔工人收集並在位於地下低層垃圾及物料回收房中央處理。
(d) Water meter, electricity meter and gas meter 水錶、電錶及氣體錶	<p>Separate water meter for each house is provided.</p> <p>The water meter of 79 Peak Road⁺ is located in the Master Water Meter Room of the Development.</p> <p>The water meters of 79A[^], 77A, 77B, 77C, 77D, 77E and 77F Peak Road are located in the water meter cabinets at the common areas of the Development.</p> <p>Separate electricity meter for each house is provided at the Low Voltage Main Switch Room in the Development.</p> <p>Separate gas meter for each house is provided at the common area of the Development.</p> <p>The gas meter of 79 Peak Road⁺ is provided in the carpark.</p> <p>The gas meter of 79A Peak Road[^] is provided in the plant room lobby next to the F.S. Pump Room.</p> <p>The gas meter of 77A, 77B, 77C, 77E and 77F Peak Road is provided at the common area of Development.</p> <p>The gas meter of 77D Peak Road is provided in the A/C plant room.</p>	<p>每間獨立屋提供獨立水錶。</p> <p>山頂道79號⁺之水錶位於發展項目之總水錶房。</p> <p>山頂道79A[^]、77A、77B、77C、77D、77E及77F號之水錶位於發展項目公用地方之水錶櫃內。</p> <p>每間獨立屋之獨立電錶設於發展項目的低壓配電室。</p> <p>獨立屋之獨立氣體錶設於發展項目公用地方內。</p> <p>山頂道79號⁺之氣體錶設於車庫內。</p> <p>山頂道79A號[^]之氣體錶設於消防泵房旁之機房大堂內。</p> <p>山頂道77A號、77B號、77C號、77E號及77F號之氣體錶設於發展項目的公用地方內。</p> <p>山頂道77D號之氣體錶設於空調機房內。</p>

The Vendor undertakes that if lifts or appliances of the specified brand name or model number are not installed in the Development, lifts or appliances of comparable quality will be installed.

賣方承諾如該項目中沒有安裝指明品牌名稱或產品型號的升降機或設備，便會安裝品質相若的升降機或設備。

+ The above residential property is/was owned by Affluent Peak Limited. The shares of the holding company of the said company have been transferred and the said company has no longer been associated corporation of Wharf Peak Properties Limited. Information on the fittings, finishes and appliances of the above property set out in this sales brochure are based on the plans as at the date of the transfer.

+ 上述住宅物業由Affluent Peak Limited擁有。該公司的控權公司的股份已轉讓，該公司不再是Wharf Peak Properties Limited的有聯繫法團。本售樓說明書所載上述物業的裝置、裝修物料及設備乃以轉讓日期的圖則為準。

^ The above residential property is/was owned by Deluxe Achieve Limited. The shares of the holding company of the said company have been transferred and the said company has no longer been associated corporation of Wharf Peak Properties Limited. Information on the fittings, finishes and appliances of the above property set out in this sales brochure are based on the plans as at the date of the transfer.

^ 上述住宅物業由Deluxe Achieve Limited擁有。該公司的控權公司的股份已轉讓，該公司不再是Wharf Peak Properties Limited的有聯繫法團。本售樓說明書所載上述物業的裝置、裝修物料及設備乃以轉讓日期的圖則為準。

5. Security facilities 保安設施

Item 細項	Description	描述
Security System 保安系統	79 Peak Road ⁺ : CCTV cameras are provided at Ground Floor Carpark, lift, Yard and Garden. Motion detectors are provided in Yard and Garden.	山頂道79號 ⁺ ：地下停車場、升降機、庭院及花園裝有閉路電視。庭院及花園裝有移動探測器。
	79A [^] , 77A, 77C, 77D and 77E Peak Road: CCTV cameras are provided at Lower Ground Floor Carpark, lift, Yard and Garden. Motion detectors in Yard and Garden.	山頂道79A [^] , 77A, 77C, 77D及77E號：地下低層停車場、升降機、庭院及花園裝有閉路電視。庭院及花園裝有移動探測器。
	77B and 77F Peak Road: CCTV cameras are provided at Lower Ground Floor Carpark, lift and Garden. Motion detectors are provided in Garden.	山頂道77B及77F號：地下低層停車場、升降機及花園裝有閉路電視。花園裝有移動探測器。
	77A, 77D, 77F and 79 Peak Road ⁺ : Magnetic door contacts are provided at entrance doors. Magnetic window contacts and glass break sensors are provided at some windows. Smoke detector and gas leakage detector are provided in the Kitchen.	山頂道77A、77D、77F及79號 ⁺ ：入口大門裝有磁門觸點。部份窗戶裝有磁窗觸點及玻璃破碎感應器。廚房裝有煙霧探測器及氣體洩漏探測器。
	77A, 77D, 77F and 79 Peak Road ⁺ : Panic alarm buttons are provided at Master Ensuite and Store Room. The signals will be delivered to the guard house directly.	山頂道77A、77D、77F及79號 ⁺ ：主人套房及儲物室設有警報按鈕。訊號將直接傳送至警衛室。
	Visitor panel for access control is provided at main entrance of the Development connecting to the main panel of each house.	訪客進出控制系統設於發展項目主入口，並連繫至每間獨立屋的主控制面板。
	Smart card readers for access control are provided at the Development main entrance and Carpark vehicular entrance.	發展項目主入口及停車場車輛入口裝有進出控制智能卡系統。

The Vendor undertakes that if lifts or appliances of the specified brand name or model number are not installed in the Development, lifts or appliances of comparable quality will be installed.

+ The above residential property is/was owned by Affluent Peak Limited. The shares of the holding company of the said company have been transferred and the said company has no longer been associated corporation of Wharf Peak Properties Limited. Information on the fittings, finishes and appliances of the above property set out in this sales brochure are based on the plans as at the date of the transfer.

[^] The above residential property is/was owned by Deluxe Achieve Limited. The shares of the holding company of the said company have been transferred and the said company has no longer been associated corporation of Wharf Peak Properties Limited. Information on the fittings, finishes and appliances of the above property set out in this sales brochure are based on the plans as at the date of the transfer.

賣方承諾如該項目中沒有安裝指明品牌名稱或產品型號的升降機或設備，便會安裝品質相若的升降機或設備。

+ 上述住宅物業由Affluent Peak Limited擁有。該公司的控權公司的股份已轉讓，該公司不再是Wharf Peak Properties Limited的有聯繫法團。本售樓說明書所載上述物業的裝置、裝修物料及設備乃以轉讓日期的圖則為準。

[^] 上述住宅物業由Deluxe Achieve Limited擁有。該公司的控權公司的股份已轉讓，該公司不再是Wharf Peak Properties Limited的有聯繫法團。本售樓說明書所載上述物業的裝置、裝修物料及設備乃以轉讓日期的圖則為準。

6. Appliances 設備

79 Peak Road 山頂道79號⁺

Location 位置	Appliance 設備	Brand Name 品牌名稱	Model Number 產品型號
Kitchen 廚房	Refrigerator 雪櫃	Sub-Zero	ICBBI-42S/O
	Undercounter Wine Cabinet 枱下式酒櫃	Sub-Zero	ICBUW-24S
	Undercounter Freezer Drawer 枱下式凍櫃抽屜	Sub-Zero	ID-24F
	Warming Drawer 暖食物器	Miele	ESW 6229
	Microwave Oven 微波爐	Miele	M 6262
	Steam Oven 蒸爐	Miele	DG 6800
	Emperor Oven 焗爐	Miele	H 6890 BP
	Dishwasher 洗碗碟機	Miele	G 6160 SCVI
	Washing Machine 洗衣機	Miele	WDA 101
	Heat Pump Tumble Dryer 乾衣機	Miele	TDA 140C
	Coffee Bean Machine 咖啡機	Miele	CVA 6800
	Cooker Hood 抽油煙機	Miele	DA 5320 W SP (1800mm width)
	Combi-Set-Gas Wok 組合式炒鑊氣體煮食爐	Miele	CS 1018
	Combi-Set-Stove Burners 組合式雙頭氣體煮食爐	Miele	CS 1013-1
	Combi-Set-Barbecue Grill 組合式燒烤爐	Miele	CS 1312 BG
Hydro Tap 隱藏式冷熱飲用水機	Zip	G4 BC 100/75	
Master Bathroom 主人浴室	Steam Generator 加濕器	Mr. Steam	MS400EC-1
	Ceiling Speaker 天花揚聲器	Mr. Steam	MSSPEAKERSRD-WH
Her Dressing Room 女主人衣帽間	Cosmetic Fridge 化妝品雪櫃	Biszet	B7 COSMETICS and MEDICINE COOLER
	Safe box 保險箱	Agresti	924
Ground Floor staircase lobby 地下樓梯大堂	Dry cleaner 乾衣機	V-Zug	TPSRBSLWP
Roof 天台	BBQ Grill 燒烤爐	Beefeater	Signature S3000S (Code: 21840)
	Refrigerator 雪櫃	Sub-Zero	UC-24RO

VRV Multi Air Conditioning System VRV分體式空調

Brand Name 品牌名稱	Model Number 產品型號
Daikin Air-conditioning 大金空調	FJDP28Q(P)VC
	FJDP32Q(P)VC
	FJDP50Q(P)VC
	FJDP63Q(P)VC
	FJDP71Q(P)VC
	FXMFP224AB
	RJZQ8AAAY
	RJZQ12AAAY

Exhaust Fan 抽氣扇

Floor 樓層	Location 位置	Brand Name 品牌名稱	Model Number 產品型號
Ground Floor 地下	Sprinkler Water Pump Room 消防花灑水泵房	NICOTRA	DDM7/7E6G3304
	F.S. Pump Room 消防泵房		
	Potable and Flushing Water Pump Room 食水及沖廁水泵房		
	Carpark 停車場		DDM9/9E6G3501
	Filtration Plant Room 泳池濾水泵房		DDM7/7E6G3304

The Vendor undertakes that if lifts or appliances of the specified brand name or model number are not installed in the Development, lifts or appliances of comparable quality will be installed.

賣方承諾如該項目中沒有安裝指明品牌名稱或產品型號的升降機或設備，便會安裝品質相若的升降機或設備。

⁺ The above residential property is/was owned by Affluent Peak Limited. The shares of the holding company of the said company have been transferred and the said company has no longer been associated corporation of Wharf Peak Properties Limited. Information on the fittings, finishes and appliances of the above property set out in this sales brochure are based on the plans as at the date of the transfer.

⁺ 上述住宅物業由Affluent Peak Limited擁有。該公司的控權公司的股份已轉讓，該公司不再是Wharf Peak Properties Limited的有聯繫法團。本售樓說明書所載上述物業的裝置、裝修物料及設備乃以轉讓日期的圖則為準。

6. Appliances 設備

79 Peak Road 山頂道79號

Exhaust Fan 抽氣扇			
Floor 樓層	Location 位置	Brand Name 品牌名稱	Model Number 產品型號
Upper Ground Floor 地面高層	Restroom in Store Room 儲物室內洗手間	OSTBERG	LPK125A
	Kitchen 廚房		RK600X300F1
	Restroom 洗手間		LPK125A
	Bathroom 1 浴室 1		
First Floor 一樓	Bathroom 2 浴室 2		
	Bathroom 3 浴室 3		
	Restroom 洗手間		
	Master Bathroom 主人浴室		

Dehumidifier 抽濕機			
Floor 樓層	Location 位置	Brand Name 品牌名稱	Model Number 產品型號
Ground Floor 地下	Carpark 停車場	Cold Magic 高美	CDH-22R2B
Upper Ground Floor 地面高層	Ensuite 1 套房 1		DVH-22R2
	Dressing Room 衣帽間		CDH-22R2B
First Floor 一樓	Ensuite 3 套房 3		DVH-22R2
	Dressing Room 衣帽間		CDH-22R2B
	Ensuite 2 套房 2		DVH-22R2
	His Dressing Room 男主人衣帽間		CDH-22R2B
	Her Dressing Room 女主人衣帽間		CDH-22R2B
	Master Ensuite 主人套房		DVH-22R2

NCCO Air Treatment Unit NCCO空氣淨化機			
Floor 樓層	Location 位置	Brand Name 品牌名稱	Model Number 產品型號
Upper Ground Floor 地面高層	Library 書房	b-MOLA	RA-801
	Ensuite 1 套房 1		
First Floor 一樓	His Dressing Room 男主人衣帽間		
	Master Ensuite 主人套房		
	Ensuite 2 套房 2		
	Ensuite 3 套房 3		
	Family Room 起居室		

Gas Water Heater 煤氣熱水爐			
Floor 樓層	Location 位置	Brand Name 品牌名稱	Model Number 產品型號
Upper Ground Floor 地面高層	Kitchen 廚房	TGC	NJW220TFQL
Roof Floor 天台	-		

Electric Water Heater 電熱水爐			
Floor 樓層	Location 位置	Brand Name 品牌名稱	Model Number 產品型號
Upper Ground Floor 地面高層	Bathroom 1 浴室 1	Stiebel Eltron	DHM 6
	Restroom 洗手間		
First Floor 一樓	Bathroom 2 浴室 2		
	Bathroom 3 浴室 3		
	Restroom 洗手間		
	Master Bathroom 主人浴室		

The Vendor undertakes that if lifts or appliances of the specified brand name or model number are not installed in the Development, lifts or appliances of comparable quality will be installed.

賣方承諾如該項目中沒有安裝指明品牌名稱或產品型號的升降機或設備，便會安裝品質相若的升降機或設備。

6. Appliances 設備

79A Peak Road 山頂道79A號[^]

Location 位置	Appliance 設備	Brand Name 品牌名稱	Model Number 產品型號
Kitchen 廚房	Refrigerator 雪櫃	Sub-Zero	ICBBI-42S/O
	Undercounter Wine Cabinet 枱下式酒櫃	Sub-Zero	ICBUW-24S
	Undercounter Freezer Drawer 枱下式凍櫃抽屜	Sub-Zero	ICBID-24RO
	Warming Drawer 暖食物器	Miele	ESW 6229 X
	Microwave Oven 微波爐	Miele	M 6262
	Steam Oven 蒸爐	Miele	DG 6800
	Emperor Oven 焗爐	Miele	H 6890 BP
	Dishwasher 洗碗碟機	Miele	G 6160 SCVI
	Washing Machine 洗衣機	Miele	WDA 101
	Heat Pump Tumble Dryer 乾衣機	Miele	TDA 140C
	Coffee Bean Machine 咖啡機	Miele	CVA 6800
	Cooker Hood 抽油煙機	Miele	DA 5320 W SP (1800mm width)
	Combi-Set-Gas Wok 組合式炒鑊氣體煮食爐	Miele	CS 1018
	Combi-Set-Stove Burners 組合式雙頭氣體煮食爐	Miele	CS 1013-1
	Combi-Set-Barbecue Grill 組合式燒烤爐	Miele	CS 1312 BG
Hydro Tap 隱藏式冷熱飲用水機	Zip	G4 BC 100/75	
Master Bathroom 主人浴室	Steam Generator 加濕器	Mr. Steam	MSSUPER6EC1X
	Ceiling Speaker 天花揚聲器	Mr. Steam	MSSPEAKERSRD-WH
Roof 天台	BBQ Grill 燒烤爐	Beefeater	Signature S3000S (Code: 21840)
	Refrigerator 雪櫃	Sub-Zero	UC-24RO

VRV Multi Air Conditioning System VRV分體式空調

Brand Name 品牌名稱	Model Number 產品型號
Daikin Air-conditioning 大金空調	FJDP28Q(P)VC
	FJDP32Q(P)VC
	FJDP50Q(P)VC
	FJDP63Q(P)VC
	FJDP71Q(P)VC
	FXMFP224AB
	RJZQ12AA Y
	RUXYQ8AB

Exhaust Fan 抽氣扇

Floor 樓層	Location 位置	Brand Name 品牌名稱	Model Number 產品型號
Lower Ground Floor 地下低層	Sprinkler Water Pump Room 消防花灑水泵房	NICOTRA	DDM7/7E6G3304
	F.S. Pump Room 消防泵房		
	Potable and Flushing Water Pump Room 食水及沖廁水泵房		DDM9/9E6G3501
	Carpark 停車場		DDM7/7E6G3304
Ground Floor 地下	Filtration Plant Room 泳池濾水泵房	NICOTRA	DDM7/7E6G3304
	Restroom 洗手間	OSTBERG	LPK125A
	Kitchen 廚房	OSTBERG	RK600X300F1
First Floor 一樓	Bathroom 浴室	OSTBERG	LPK125A
	Bathroom 1 浴室 1		
	Bathroom 2 浴室 2		
	Bathroom 3 浴室 3		
Second Floor 二樓	Bathroom 4 浴室 4	OSTBERG	LPK125A
	Bathroom 5 浴室 5		
	Her Bathroom 女主人浴室		

The Vendor undertakes that if lifts or appliances of the specified brand name or model number are not installed in the Development, lifts or appliances of comparable quality will be installed.

賣方承諾如該項目中沒有安裝指明品牌名稱或產品型號的升降機或設備，便會安裝品質相若的升降機或設備。

[^] The above residential property is/was owned by Deluxe Achieve Limited. The shares of the holding company of the said company have been transferred and the said company has no longer been associated corporation of Wharf Peak Properties Limited. Information on the fittings, finishes and appliances of the above property set out in this sales brochure are based on the plans as at the date of the transfer.

[^] 上述住宅物業由Deluxe Achieve Limited擁有。該公司的控權公司的股份已轉讓，該公司不再是Wharf Peak Properties Limited的有聯繫法團。本售樓說明書所載上述物業的裝置、裝修物料及設備乃以轉讓日期的圖則為準。

6. Appliances 設備

79A Peak Road 山頂道79A號

Dehumidifier 抽濕機			
Floor 樓層	Location 位置	Brand Name 品牌名稱	Model Number 產品型號
Lower Ground Floor 地下低層	Carpark 停車場	Cold Magic 高美	DVH-22R2
Ground Floor 地下	Study Room 書房		DVH-22R2
First Floor 一樓	Ensuite 1 套房1		DVH-22R2 + CDH-22R2B
	Ensuite 2 套房2		DVH-22R2 + CDH-22R2B
	Ensuite 3 套房3		DVH-22R2 + CDH-22R2B
	Ensuite 4 套房4		CDH-22R2B
Second Floor 二樓	Dressing Room 衣帽間		DVH-22R2
	Master Ensuite 主人套房		DVH-22R2
	Ensuite 5 套房5		CDH-22R2B
	Dressing Room in Master Ensuite 主人套房內衣帽間		DVH-22R2

NCCO Air Treatment Unit NCCO空氣淨化機			
Floor 樓層	Location 位置	Brand Name 品牌名稱	Model Number 產品型號
Ground Floor 地下	Study Room 書房	b-MOLA	RA-801
First Floor 一樓	Ensuite 1 套房1		
	Ensuite 2 套房2		
	Ensuite 3 套房3		
	Ensuite 4 套房4		
Second Floor 二樓	Ensuite 5 套房5		
	Master Ensuite 主人套房		

Towngas Water Heater 煤氣熱水爐			
Floor 樓層	Location 位置	Brand Name 品牌名稱	Model Number 產品型號
Ground Floor 地下	Kitchen 廚房	TGC	NJW220TFQL
Second Floor 二樓	Her Bathroom 女主人浴室		
Roof Floor 天台	-		

Electric Water Heater 電熱水爐			
Floor 樓層	Location 位置	Brand Name 品牌名稱	Model Number 產品型號
Ground Floor 地下	Restroom 洗手間	Stiebel Eltron	DHM 6
	Bathroom 浴室		
First Floor 一樓	Bathroom 1 浴室1		
	Bathroom 2 浴室2		
	Bathroom 3 浴室3		
	Bathroom 4 浴室4		
Second Floor 二樓	Bathroom 5 浴室5		
	Her Bathroom 女主人浴室		

The Vendor undertakes that if lifts or appliances of the specified brand name or model number are not installed in the Development, lifts or appliances of comparable quality will be installed.

賣方承諾如該項目中沒有安裝指明品牌名稱或產品型號的升降機或設備，便會安裝品質相若的升降機或設備。

6. Appliances 設備

77A Peak Road 山頂道77A號

Location 位置	Appliance 設備	Brand Name 品牌名稱	Model Number 產品型號
Kitchen 廚房	Refrigerator 雪櫃	Sub-Zero	ICBBI-42S/O
	Undercounter Wine Cabinet 枱下式酒櫃	Sub-Zero	ICBUW-24S
	Undercounter Freezer Drawer 枱下式凍櫃抽屜	Sub-Zero	ID-24F
	Warming Drawer 暖食物器	Miele	ESW 6229
	Microwave Oven 微波爐	Miele	M 6262
	Steam Oven 蒸爐	Miele	DG 6800
	Emperor Oven 焗爐	Miele	H 6890 BP
	Dishwasher 洗碗碟機	Miele	G 6160 SCVI
	Washing Machine 洗衣機	Miele	WDA 101
	Heat Pump Tumble Dryer 乾衣機	Miele	TDA 140C
	Coffee Bean Machine 咖啡機	Miele	CVA 6800
	Cooker Hood 抽油煙機	Miele	DA 5320 W SP (1500mm width)
	Combi-Set-Gas Wok 組合式炒鑊氣體煮食爐	Miele	CS 1018
	Combi-Set-Stove Burners 組合式雙頭氣體煮食爐	Miele	CS 1013-1
	Combi-Set-Barbecue Grill 組合式燒烤爐	Miele	CS 1312 BG
Hydro Tap 隱藏式冷熱飲用水機	Zip	G4 BC 100/75	
Master Bathroo 主人浴室	Steam Generator 加濕器	Mr. Steam	MS400EC-1
	Ceiling Speaker 天花揚聲器	Mr. Steam	MSSPEAKERSRD-WH
Yard 庭院	BBQ Grill 燒烤爐	Beefeater	Signature S3000S (Code: 21840)
	Refrigerator 雪櫃	Sub-Zero	UC-24RO

VRV Multi Air Conditioning System VRV分體式空調	
Brand Name 品牌名稱	Model Number 產品型號
Daikin Air-conditioning 大金空調	FJDP28Q(P)VC
	FJDP32Q(P)VC
	FJDP50Q(P)VC
	FJDP63Q(P)VC
	FJDP71Q(P)VC
	FJDP90Q(P)VC
	FXMFP224AB
	RJZQ8AAAY
	RJZQ12AAAY

Exhaust Fan 抽氣扇			
Floor 樓層	Location 位置	Brand Name 品牌名稱	Model Number 產品型號
Lower Ground Floo 地下低層	F.S. and Sprinkler Water Pump Room 消防泵及消防花灑水泵房	NICOTRA	DDM7/7E6G3304
	Potable and Flushing Water Pump Room 食水及沖廁水泵房		
	Carpark 停車場		DDM9/9E6G3501
	Filtration Plant Room 泳池濾水泵房	NICOTRA	DDM7/7E6G3304
Ground Floor 地下	Restroom in Store Room 儲物室內洗手間	OSTBERG	LPK125A
	Kitchen 廚房		RK600X300F1
	Restroom 洗手間		LPK125A

The Vendor undertakes that if lifts or appliances of the specified brand name or model number are not installed in the Development, lifts or appliances of comparable quality will be installed.

賣方承諾如該項目中沒有安裝指明品牌名稱或產品型號的升降機或設備，便會安裝品質相若的升降機或設備。

6. Appliances 設備

77A Peak Road 山頂道77A號

Exhaust Fan 抽氣扇			
Floor 樓層	Location 位置	Brand Name 品牌名稱	Model Number 產品型號
First Floor 一樓	Bathroom 1 浴室 1	OSTBERG	LPK125A
	Bathroom 2 浴室 2		
	Bathroom 3 浴室 3		
	Restroom 洗手間		
Second Floor 二樓	Master Bathroom 主人浴室		LPK200A

Dehumidifier 抽濕機			
Floor 樓層	Location 位置	Brand Name 品牌名稱	Model Number 產品型號
Lower Ground Floor 地下低層	Carpark 停車場		CDH-22R2B
First Floor 一樓	Ensuite 1 套房 1	Cold Magic 高美	DVH-22R2
	Ensuite 2 套房 2		DVH-22R2
	Ensuite 3 套房 3		DVH-22R2
	Dressing Room 衣帽間		CDH-22R2B
Second Floor 二樓	Master Ensuite 主人套房		DVH-22R2
	His Dressing 男主人衣帽間		CDH-22R2B
	Her Dressing 女主人衣帽間		CDH-22R2B

NCCO Air Treatment Unit NCCO空氣淨化機			
Floor 樓層	Location 位置	Brand Name 品牌名稱	Model Number 產品型號
First Floor 一樓	Ensuite 3 套房 3	b-MOLA	RA-801
	Study Room 書房		
	Ensuite 2 套房 2		
	Family Room 起居室		
	Ensuite 1 套房 1		
Second Floor 二樓	Her Dressing 女主人衣帽間		
	Master Ensuite 主人套房		

Towngas Water Heater 煤氣熱水爐			
Floor 樓層	Location 位置	Brand Name 品牌名稱	Model Number 產品型號
Ground Floor 地下	Kitchen 廚房	TGC	NJW220TFQL
Second Floor 二樓	Master Bathroom 主人浴室		

Electric Water Heater 電熱水爐			
Floor 樓層	Location 位置	Brand Name 品牌名稱	Model Number 產品型號
Ground Floor 地下	Restroom 洗手間	Stiebel Eltron	DHM 6
First Floor 一樓	Bathroom 1 浴室 1		
	Bathroom 2 浴室 2		
	Bathroom 3 浴室 3		
	Restroom 洗手間		
Second Floor 二樓	Master Bathroom 主人浴室		

The Vendor undertakes that if lifts or appliances of the specified brand name or model number are not installed in the Development, lifts or appliances of comparable quality will be installed.

賣方承諾如該項目中沒有安裝指明品牌名稱或產品型號的升降機或設備，便會安裝品質相若的升降機或設備。

6. Appliances 設備

77B Peak Road 山頂道77B號

Location 位置	Appliance 設備	Brand Name 品牌名稱	Model Number 產品型號
Kitchen 廚房	Refrigerator 雪櫃	Sub-Zero	ICBBI-42S/O
	Undercounter Wine Cabinet 枱下式酒櫃	Sub-Zero	ICBUW-24S
	Undercounter Freezer Drawer 枱下式凍櫃抽屜	Sub-Zero	ICBID-24RO
	Warming Drawer 暖食物器	Miele	ESW 6229 X
	Microwave Oven 微波爐	Miele	M 6262
	Steam Oven 蒸爐	Miele	DG 6800
	Emperor Oven 焗爐	Miele	H 6890 BP
	Dishwasher 洗碗碟機	Miele	G 6160 SCVI
	Washing Machine 洗衣機	Miele	WDA 101
	Heat Pump Tumble Dryer 乾衣機	Miele	TDA 140C
	Coffee Bean Machine 咖啡機	Miele	CVA 6800
	Cooker Hood 抽油煙機	Miele	DA 5320 W SP (1500mm width)
	Combi-Set-Gas Wok 組合式炒鑊氣體煮食爐	Miele	CS 1018
	Combi-Set-Stove Burners 組合式雙頭氣體煮食爐	Miele	CS 1013-1
	Combi-Set-Barbecue Grill 組合式燒烤爐	Miele	CS 1312 BG
Hydro Tap 隱藏式冷熱飲用水機	Zip	G4 BC 100/75	
Roof 天台	BBQ Grill 燒烤爐	Beefeater	Signature S3000S (Code: 21840)
	Refrigerator 雪櫃	Sub-Zero	UC-24RO

VRV Multi Air Conditioning System VRV分體式空調

Brand Name 品牌名稱	Model Number 產品型號
Daikin Air-conditioning 大金空調	FXDP28Q(P)VC
	FXDP32Q(P)VC
	FXDP50Q(P)VC
	FXDP63Q(P)VC
	FXDP71Q(P)VC
	FXDP90Q(P)VC
	FXMFP224AB
	RUXYQ50AB

Exhaust Fan 抽氣扇

Floor 樓層	Location 位置	Brand Name 品牌名稱	Model Number 產品型號
Lower Ground Floor 地下低層	F.S. and Sprinkler Water Pump Room 消防泵及消防花灑水泵房	NICOTRA	DDM9/7E6G3405
	Potable and Flushing Water Pump Room 食水及沖廁水泵房		DDM7/7E6G3304
	Carpark 停車場		DDM9/9E6G3501
	Filtration Plant Room 泳池濾水泵房	NICOTRA	DDM7/7E6G3304
Ground Floor 地下	Restroom 洗手間	OSTBERG	LPK125A
	Kitchen 廚房	OSTBERG	RK600X300F1
First Floor 一樓	Bathroom 1 浴室 1	OSTBERG	LPK125A
	Bathroom 2 浴室 2		
	Bathroom 3 浴室 3		
	Bathroom 浴室		
Second Floor 二樓	Master Bathroom 主人浴室		LPK200A

The Vendor undertakes that if lifts or appliances of the specified brand name or model number are not installed in the Development, lifts or appliances of comparable quality will be installed.

賣方承諾如該項目中沒有安裝指明品牌名稱或產品型號的升降機或設備，便會安裝品質相若的升降機或設備。

6. Appliances 設備

77B Peak Road 山頂道77B號

Dehumidifier 抽濕機			
Floor 樓層	Location 位置	Brand Name 品牌名稱	Model Number 產品型號
Lower Ground Floor 地下低層	Carpark 停車場	Cold Magic 高美	DVH-22R2
First Floor 一樓	Ensuite 1 套房1		DVH-22R2 + CDH-22R2B
	Ensuite 2 套房2		DVH-22R2 + CDH-22R2B
	Ensuite 3 套房3		DVH-22R2 + CDH-22R2B
Second Floor 二樓	Dressing Room 衣帽間		CDH-22R2B
	Master Ensuite 主人套房		DVH-22R2

NCCO Air Treatment Unit NCCO空氣淨化機			
Floor 樓層	Location 位置	Brand Name 品牌名稱	Model Number 產品型號
First Floor 一樓	Ensuite 1 套房1	b-MOLA	RA-801
	Ensuite 2 套房2		
	Ensuite 3 套房3		
Second Floor 二樓	Master Ensuite 主人套房		

Towngas Water Heater 煤氣熱水爐			
Floor 樓層	Location 位置	Brand Name 品牌名稱	Model Number 產品型號
Ground Floor 地下	Kitchen 廚房	TGC	NJW220TFQL
Second Floor 二樓	Master Bathroom 主人浴室		

Electric Water Heater 電熱水爐			
Floor 樓層	Location 位置	Brand Name 品牌名稱	Model Number 產品型號
Ground Floor 地下	Restroom 洗手間	Stiebel Eltron	DHM 6
First Floor 一樓	Bathroom 1 浴室1		
	Bathroom 2 浴室2		
	Bathroom 3 浴室3		
	Bathroom 浴室		
Second Floor 二樓	Master Bathroom 主人浴室		

The Vendor undertakes that if lifts or appliances of the specified brand name or model number are not installed in the Development, lifts or appliances of comparable quality will be installed.

賣方承諾如該項目中沒有安裝指明品牌名稱或產品型號的升降機或設備，便會安裝品質相若的升降機或設備。

6. Appliances 設備

77C Peak Road 山頂道77C號

Location 位置	Appliance 設備	Brand Name 品牌名稱	Model Number 產品型號
Kitchen 廚房	Refrigerator 雪櫃	Sub-Zero	ICBBI-42S/O
	Undercounter Wine Cabinet 枱下式酒櫃	Sub-Zero	ICBUW-24/S
	Undercounter Freezer Drawer 枱下式凍櫃抽屜	Sub-Zero	ICBID-24RO
	Undercounter Fridge / Freezer with Ice-maker 枱下式雪櫃連制冰凍櫃	Sub-Zero	UC-24C
	Warming Drawer 暖食物器	Miele	ESW 6229X
	Microwave Oven 微波爐	Miele	M 6262
	Steam Oven 蒸爐	Miele	DG 6800
	Emperor Oven 焗爐	Miele	H 6890 BP
	Dishwasher 洗碗碟機	Miele	G 6160 SCVI
	Washing Machine 洗衣機	Miele	WDA 101
	Heat Pump Tumble Dryer 乾衣機	Miele	TDA 140C
	Cooker Hood 抽油煙機	Miele	DA 5320 W
	Combi-Set-Gas Wok 組合式炒鑊氣體煮食爐	Miele	CS 1018
	Combi-Set-Stove Burners 組合式雙頭氣體煮食爐	Miele	CS 1013-1
	Combi-Set-Barbecue Grill 組合式燒烤爐	Miele	CS 1312 BG
Coffee Bean Machine 咖啡機	Miele	CVA 6800	
HydroTap 隱藏式冷熱飲用水機	Zip	G4 BC 100/75 (HT1764)	
Dining Room 飯廳	Full Height Wine Cellar 酒櫃	Sub-Zero	ICBIW-24
Yard 庭院	BBQ Grill 燒烤爐	Beefeater	Signature S3000 S (Code 21840)
	Refrigerator 雪櫃	Sub-Zero	UC-24RO

VRV Multi Air Conditioning System VRV分體式空調

Brand Name 品牌名稱	Model Number 產品型號
Daikin Air-conditioning 大金空調	FXDP28Q(P)VC
	FXDP32Q(P)VC
	FXDP50Q(P)VC
	FXDP63Q(P)VC
	FXDP71Q(P)VC
	FXDP90Q(P)VC
	FXMFP224AB
	RUXYQ50AB

Exhaust Fan 抽氣扇

Floor 樓層	Location 位置	Brand Name 品牌名稱	Model Number 產品型號
Lower Ground Floor 地下低層	Carpark 停車場	NICOTRA	DDM9/9E6G3501
	Filtration Plant Room 泳池濾水泵房		DDM7/7E6G3304
	Flushing Water Pump Room 沖廁水泵房		
Ground Floor 地下	F.S. & Sprinkler Water Pump Room 消防泵及消防花灑水泵房	OSTBERG	LPK125A
	Potable Water Pump Room 食水泵房		LPK200B
	Restroom 洗手間		LPK125A
Kitchen 廚房			
First Floor 一樓	Bathroom 1 浴室 1	OSTBERG	LPK125A
	Bathroom 2 浴室 2		
	Bathroom 3 浴室 3		
	Restroom 洗手間		
Second Floor 二樓	Master Bathroom 主人浴室		LPK200A

The Vendor undertakes that if lifts or appliances of the specified brand name or model number are not installed in the Development, lifts or appliances of comparable quality will be installed.

賣方承諾如該項目中沒有安裝指明品牌名稱或產品型號的升降機或設備，便會安裝品質相若的升降機或設備。

6. Appliances 設備

77C Peak Road 山頂道77C號

Dehumidifier 抽濕機			
Floor 樓層	Location 位置	Brand Name 品牌名稱	Model Number 產品型號
Lower Ground Floor 地下低層	Carpark 停車場	Cold Magic 高美	DVH-22R2
First Floor 一樓	Ensuite 1 套房1		DVH-22R2
	Ensuite 2 套房2		DVH-22R2
	Ensuite 3 套房3		DVH-22R2
Second Floor 二樓	Master Ensuite 主人套房	Cold Magic 高美	DVH-22R2
	Dressing Room 衣帽間		CDH-22R2B

NCCO Air Treatment Unit NCCO空氣淨化機			
Floor 樓層	Location 位置	Brand Name 品牌名稱	Model Number 產品型號
First Floor 一樓	Ensuite 1 套房1	b-MOLA	RA-801
	Ensuite 2 套房2		
	Pantry 茶水間		
Second Floor 二樓	Master Ensuite 主人套房		

Towngas Water Heater 煤氣熱水爐			
Floor 樓層	Location 位置	Brand Name 品牌名稱	Model Number 產品型號
Ground Floor 地下	Kitchen 廚房	TGC	NJW220TFQL
Second Floor 二樓	Master Bathroom 主人浴室		

Electric Water Heater 電熱水爐			
Floor 樓層	Location 位置	Brand Name 品牌名稱	Model Number 產品型號
Ground Floor 地下	Restroom 洗手間	Stiebel Eltron	DHM 6
First Floor 一樓	Bathroom 1 浴室1		
	Bathroom 2 浴室2		
	Bathroom 3 浴室3		
	Restroom 洗手間		
Second Floor 二樓	Master Bathroom 主人浴室		

The Vendor undertakes that if lifts or appliances of the specified brand name or model number are not installed in the Development, lifts or appliances of comparable quality will be installed.

賣方承諾如該項目中沒有安裝指明品牌名稱或產品型號的升降機或設備，便會安裝品質相若的升降機或設備。

6. Appliances 設備

77D Peak Road 山頂道77D號

Location 位置	Appliance 設備	Brand Name 品牌名稱	Model Number 產品型號
Kitchen 廚房	Refrigerator 雪櫃	Sub-Zero	ICBBI-42S/O
	Undercounter Wine Cabinet 枱下式酒櫃	Sub-Zero	ICBUW-24S
	Undercounter Freezer Drawer 枱下式凍櫃抽屜	Sub-Zero	ID-24F
	Warming Drawer 暖食物器	Miele	ESW 6229
	Microwave Oven 微波爐	Miele	M 6262
	Steam Oven 蒸爐	Miele	DG 6800
	Emperor Oven 焗爐	Miele	H 6890 BP
	Dishwasher 洗碗碟機	Miele	G 6160 SCVI
	Coffee Bean Machine 咖啡機	Miele	CVA 6800
	Cooker Hood 抽油煙機	Miele	DA 5320 W SP (1500mm width)
	Combi-Set-Gas Wok 組合式炒鑊氣體煮食爐	Miele	CS 1018
	Combi-Set-Stove Burners 組合式雙頭氣體煮食爐	Miele	CS 1013-1
	Combi-Set-Barbecue Grill 組合式燒烤爐	Miele	CS 1312 BG
Hydro Tap 隱藏式冷熱飲用水機	Zip	G4 BC 100/75	
Store Room 儲物室	Washing Machine 洗衣機	Miele	WDA 101
	Heat Pump Tumble Dryer 乾衣機	Miele	TDA 140C
Yard 庭院	BBQ Grill 燒烤爐	Beefeater	Signature S3000S (Code: 21840)
	Refrigerator 雪櫃	Sub-Zero	UC-24RO

VRV Multi Air Conditioning System VRV分體式空調

Brand Name 品牌名稱	Model Number 產品型號
Daikin Air-conditioning 大金空調	FXDP28Q(P)VC
	FXDP32Q(P)VC
	FXDP50Q(P)VC
	FXDP63Q(P)VC
	FXDP71Q(P)VC
	FXDP90Q(P)VC
	FXMFP224AB
	RUXYQ50AB

Exhaust Fan 抽氣扇

Floor 樓層	Location 位置	Brand Name 品牌名稱	Model Number 產品型號
Lower Ground Floor 地下低層	Potable and Flushing Water Pump Room 食水及沖廁水泵房	NICOTRA	DDM7/7E6G3304
	Carpark 停車場		DDM9/9E6G3501
	Filtration Plant Room 泳池濾水泵房		DDM7/7E6G3304
Ground Floor 地下	F.S. and Sprinkler Water Pump Room 消防泵及消防花灑水泵房	OSTBERG	LPK125A
	Restroom in Store Room 儲物室內洗手間		LPK200B
	Kitchen 廚房		LPK125A
First Floor 一樓	Bathroom 浴室	OSTBERG	LPK125A
	Bathroom 1 浴室 1		LPK125A
	Bathroom 2 浴室 2		LPK125A
Second Floor 二樓	Bathroom 3 浴室 3	OSTBERG	LPK125A
	Master Bathroom 主人浴室		LPK200A

The Vendor undertakes that if lifts or appliances of the specified brand name or model number are not installed in the Development, lifts or appliances of comparable quality will be installed.

賣方承諾如該項目中沒有安裝指明品牌名稱或產品型號的升降機或設備，便會安裝品質相若的升降機或設備。

6. Appliances 設備

77D Peak Road 山頂道77D號

Dehumidifier 抽濕機			
Floor 樓層	Location 位置	Brand Name 品牌名稱	Model Number 產品型號
Lower Ground Floor 地下低層	Carpark 停車場	Cold Magic 高美	CDH-22R2B
First Floor 一樓	Ensuite 1 套房1		DVH-22R2
	Ensuite 2 套房2		DVH-22R2
	Ensuite 3 套房3		DVH-22R2
	Dressing Room 衣帽間		CDH-22R2B
Second Floor 二樓	Master Ensuite 主人套房		DVH-22R2
	Dressing Room 衣帽間		CDH-22R2B

NCCO Air Treatment Unit NCCO空氣淨化機			
Floor 樓層	Location 位置	Brand Name 品牌名稱	Model Number 產品型號
First Floor 一樓	Family Room 起居室	b-MOLA	RA-801
	Ensuite 1 套房1		
	Ensuite 2 套房2		
	Ensuite 3 套房3		
Second Floor 二樓	Master Ensuite 主人套房		
	Dressing Room 衣帽間		

Towngas Water Heater 煤氣熱水爐			
Floor 樓層	Location 位置	Brand Name 品牌名稱	Model Number 產品型號
Ground Floor 地下	Kitchen 廚房	TGC	NJW220TFQL
Second Floor 二樓	Master Bathroom 主人浴室		

Electric Water Heater 電熱水爐			
Floor 樓層	Location 位置	Brand Name 品牌名稱	Model Number 產品型號
Ground Floor 地下	Bathroom 浴室	Stiebel Eltron	DHM 6
First Floor 一樓	Bathroom 1 浴室1		
	Bathroom 2 浴室2		
	Bathroom 3 浴室3		
Second Floor 二樓	Master Bathroom 主人浴室		

The Vendor undertakes that if lifts or appliances of the specified brand name or model number are not installed in the Development, lifts or appliances of comparable quality will be installed.

賣方承諾如該項目中沒有安裝指明品牌名稱或產品型號的升降機或設備，便會安裝品質相若的升降機或設備。

6. Appliances 設備

77E Peak Road 山頂道77E號

Location 位置	Appliance 設備	Brand Name 品牌名稱	Model Number 產品型號
Kitchen 廚房	Refrigerator 雪櫃	Sub-Zero	ICBBI-42S/O
	Undercounter Wine Cabinet 枱下式酒櫃	Sub-Zero	ICBUW-24S
	Undercounter Freezer Drawer 枱下式凍櫃抽屜	Sub-Zero	ICBID-24RO
	Warming Drawer 暖食物器	Miele	ESW 6229 X
	Microwave Oven 微波爐	Miele	M 6262
	Steam Oven 蒸爐	Miele	DG 6800
	Emperor Oven 焗爐	Miele	H 6890 BP
	Dishwasher 洗碗碟機	Miele	G 6160 SCVI
	Washing Machine 洗衣機	Miele	WDA 101
	Heat Pump Tumble Dryer 乾衣機	Miele	TDA 140C
	Coffee Bean Machine 咖啡機	Miele	CVA 6800
	Cooker Hood 抽油煙機	Miele	DA 5320 W SP (1500mm width)
	Combi-Set-Gas Wok 組合式炒鑊氣體煮食爐	Miele	CS 1018
	Combi-Set-Stove Burners 組合式雙頭氣體煮食爐	Miele	CS 1013-1
	Combi-Set-Barbecue Grill 組合式燒烤爐	Miele	CS 1312 BG
Hydro Tap 隱藏式冷熱飲用水機	Zip	G4 BC 100/75	
Roof 天台	BBQ Grill 燒烤爐	Beefeater	Signature S3000S (Code: 21840)
	Refrigerator 雪櫃	Sub-Zero	UC-24RO

VRV Multi Air Conditioning System VRV分體式空調

Brand Name 品牌名稱	Model Number 產品型號
Daikin Air-conditioning 大金空調	FJDP28Q(P)VC
	FJDP32Q(P)VC
	FJDP50Q(P)VC
	FJDP63Q(P)VC
	FJDP71Q(P)VC
	FXMFP224AB
	RJZQ8AAAY
	RJZQ12AAAY

Exhaust Fan 抽氣扇

Floor 樓層	Location 位置	Brand Name 品牌名稱	Model Number 產品型號
Lower Ground Floor 地下低層	Sprinkler Water Pump Room 消防花灑水泵房	NICOTRA	DDM7/7E6G3304
	F.S. Pump Room 消防泵房		
	Potable and Flushing Water Pump Room 食水及沖廁水泵房		DDM9/9E6G3501
	Carpark 停車場		DDM7/7E6G3304
Ground Floor 地下	Filtration Plant Room 泳池濾水泵房	NICOTRA	DDM7/7E6G3304
	Restroom in Store Room 儲物室內洗手間	OSTBERG	LPK125A
	Kitchen 廚房	OSTBERG	LPK200B
	Restroom 洗手間	OSTBERG	LPK125A
First Floor 一樓	Bathroom 1 浴室 1	OSTBERG	LPK125A
	Bathroom 2 浴室 2		
	Bathroom 3 浴室 3		
	Bathroom 4 浴室 4		
Second Floor 二樓	Bathroom 浴室	OSTBERG	LPK125A
	Bathroom 5 浴室 5		
	Master Bathroom 主人浴室		

The Vendor undertakes that if lifts or appliances of the specified brand name or model number are not installed in the Development, lifts or appliances of comparable quality will be installed.

賣方承諾如該項目中沒有安裝指明品牌名稱或產品型號的升降機或設備，便會安裝品質相若的升降機或設備。

6. Appliances 設備

77E Peak Road 山頂道77E號

Dehumidifier 抽濕機			
Floor 樓層	Location 位置	Brand Name 品牌名稱	Model Number 產品型號
Lower Ground Floor 地下低層	Carpark 停車場	Cold Magic 高美	DVH-22R2
Ground Floor 地下	Ensuite 1 套房1		CDH-22R2B
First Floor 一樓	Ensuite 2 套房2		DVH-22R2 + CDH-22R2B
	Ensuite 3 套房3		CDH-22R2B
	Dressing Room in Ensuite 3 套房3內衣帽間		DVH-22R2
	Ensuite 4 套房4		CDH-22R2B
Second Floor 二樓	Dressing Room in Ensuite 4 套房4內衣帽間		DVH-22R2
	Ensuite 5 套房5		DVH-22R2 + CDH-22R2B
	Master Ensuite 主人套房		DVH-22R2 + CDH-22R2B
	Dressing Room 衣帽間		DVH-22R2

NCCO Air Treatment Unit NCCO空氣淨化機			
Floor 樓層	Location 位置	Brand Name 品牌名稱	Model Number 產品型號
Ground Floor 地下	Ensuite 1 套房1	b-MOLA	RA-801
First Floor 一樓	Ensuite 2 套房2		
	Ensuite 3 套房3		
	Ensuite 4 套房4		
Second Floor 二樓	Ensuite 5 套房5		
	Master Ensuite 主人套房		

Towngas Water Heater 煤氣熱水爐			
Floor 樓層	Location 位置	Brand Name 品牌名稱	Model Number 產品型號
Ground Floor 地下	Kitchen 廚房	TGC	NJW220TFQL
Second Floor 二樓	Master Bathroom 主人浴室		

Electric Water Heater 電熱水爐			
Floor 樓層	Location 位置	Brand Name 品牌名稱	Model Number 產品型號
Ground Floor 地下	Bathroom 1 浴室1	Stiebel Eltron	DHM 6
First Floor 一樓	Bathroom 2 浴室2		
	Bathroom 3 浴室3		
	Bathroom 4 浴室4		
	Bathroom 浴室		
Second Floor 二樓	Bathroom 5 浴室 5		
	Master Bathroom 主人浴室		

The Vendor undertakes that if lifts or appliances of the specified brand name or model number are not installed in the Development, lifts or appliances of comparable quality will be installed.

賣方承諾如該項目中沒有安裝指明品牌名稱或產品型號的升降機或設備，便會安裝品質相若的升降機或設備。

6. Appliances 設備

77F Peak Road 山頂道77F號

Location 位置	Appliance 設備	Brand Name 品牌名稱	Model Number 產品型號
Kitchen 廚房	Refrigerator 雪櫃	Sub-Zero	ICBBI-42S/O
	Undercounter Wine Cabinet 枱下式酒櫃	Sub-Zero	ICBUW-24S
	Undercounter Freezer Drawer 枱下式凍櫃抽屜	Sub-Zero	ID-24F
	Warming Drawer 暖食物器	Miele	ESW 6229
	Microwave Oven 微波爐	Miele	M 6262
	Steam Oven 蒸爐	Miele	DG 6800
	Emperor Oven 焗爐	Miele	H 6890 BP
	Dishwasher 洗碗碟機	Miele	G 6160 SCVI
	Washing Machine 洗衣機	Miele	WDA 101
	Heat Pump Tumble Dryer 乾衣機	Miele	TDA 140C
	Coffee Bean Machine 咖啡機	Miele	CVA 6800
	Cooker Hood 抽油煙機	Miele	DA 5320 W SP (1500mm width)
	Combi-Set-Gas Wok 組合式炒鑊氣體煮食爐	Miele	CS 1018
	Combi-Set-Stove Burners 組合式雙頭氣體煮食爐	Miele	CS 1013-1
	Combi-Set-Barbecue Grill 組合式燒烤爐	Miele	CS 1312 BG
Hydro Tap 隱藏式冷熱飲用水機	Zip	G4 BC 100/75	
Roof 天台	BBQ Grill 燒烤爐	Beefeater	Signature S3000S (Code: 21840)
	Refrigerator 雪櫃	Sub-Zero	UC-24RO

VRV Multi Air Conditioning System VRV分體式空調

Brand Name 品牌名稱	Model Number 產品型號
Daikin Air-conditioning 大金空調	FJDP28Q(P)VC
	FJDP32Q(P)VC
	FJDP50Q(P)VC
	FJDP63Q(P)VC
	FJDP71Q(P)VC
	FJDP90Q(P)VC
	FXMFP224AB
	RJZQ8AAY
	RJZQ9AAY
	RJZQ12AAY

Exhaust Fan 抽氣扇

Floor 樓層	Location 位置	Brand Name 品牌名稱	Model Number 產品型號
E & M Floor (Below Lower Ground) 機電層(低於地下低層)	F.S. and Sprinkler Water Pump Room 消防泵及消防花灑水泵房		DDM7/7E6G3304
Lower Ground Floor 地下低層	Carpark 停車場	NICOTRA	DDM9/9E6G3501
	Filtration Plant Room 泳池濾水泵房		DDM7/7E6G3304
	Potable and Flushing Water Pump Room 食水及沖廁水泵房		DDM7/7E6G3304
Ground Floor 地下	Restroom in Store Room 儲物室內洗手間		LPK125A
	Kitchen 廚房		RK600X300F1
	Restroom 洗手間	OSTBERG	LPK125A
	Bathroom 1 浴室 1		
Bathroom 2 浴室 2			
First Floor 一樓	Bathroom 3 浴室 3		LPK200A
	Master Bathroom 主人浴室		

The Vendor undertakes that if lifts or appliances of the specified brand name or model number are not installed in the Development, lifts or appliances of comparable quality will be installed.

賣方承諾如該項目中沒有安裝指明品牌名稱或產品型號的升降機或設備，便會安裝品質相若的升降機或設備。

6. Appliances 設備

77F Peak Road 山頂道77F號

Dehumidifier 抽濕機			
Floor 樓層	Location 位置	Brand Name 品牌名稱	Model Number 產品型號
Lower Ground Floor 地下低層	Carpark 停車場	Cold Magic	CDH-22R2B
Ground Floor 地下	Ensuite 1 套房1		DVH-22R2 CDH-22R2B
	Ensuite 2 套房2		DVH-22R2
First Floor 一樓	Master Ensuite 主人套房		DVH-22R2 CDH-22R2B
	Dressing Room 衣帽間		CDH-22R2B
	Ensuite 3 套房3		DVH-22R2

NCCO Air Treatment Unit NCCO空氣淨化機			
Floor 樓層	Location 位置	Brand Name 品牌名稱	Model Number 產品型號
Ground Floor 地下	Ensuite 1 套房1	b-MOLA	RA-801
	Ensuite 2 套房2		
First Floor 一樓	Ensuite 3 套房3		
	Dressing Room 衣帽間		
	Master Ensuite 主人套房		

Towngas Water Heater 煤氣熱水爐			
Floor 樓層	Location 位置	Brand Name 品牌名稱	Model Number 產品型號
Ground Floor 地下	Kitchen 廚房	TGC	NJW220TFQL
Roof Floor 天台	-		

Electric Water Heater 電熱水爐			
Floor 樓層	Location 位置	Brand Name 品牌名稱	Model Number 產品型號
Ground Floor 地下	Bathroom 1 浴室1	Stiebel Eltron	DHM 6
	Bathroom 2 浴室2		
	Restroom 洗手間		
First Floor 一樓	Bathroom 3 浴室3		
	Master Bathroom 主人浴室		

The Vendor undertakes that if lifts or appliances of the specified brand name or model number are not installed in the Development, lifts or appliances of comparable quality will be installed.

賣方承諾如該項目中沒有安裝指明品牌名稱或產品型號的升降機或設備，便會安裝品質相若的升降機或設備。

Schedule of Mechanical and Electrical Provisions - 機電裝置數量說明表

79 Peak Road 山頂道79號⁺

Floor 樓層	Location 位置	Lighting Point 照明燈位	Home Automation Control Panel for Lighting 智能控制掣面供照明	Lighting Switch 燈掣	Electric Vehicle Charger 電動車充電器	Double Pole Switch For Exhaust Fan 抽氣扇電源掣	Infrared Occupancy Sensor for Lighting 紅外線傳感器供照明	13A Switched Socket Outlet (Twin+Single) 13安培帶掣插蘇 (雙位+單位)	Thermostat for Under Floor Heater System 地暖系統溫度控顯示器
Ground Floor 地下	Lobby 大堂	7	1	-	-	-	1	0+1	-
	Staircase 樓梯	9	1	-	-	-	-	0+2	-
	Corridor 走廊	13	-	1	-	-	-	0+0	-
	Carpark 停車場	5	-	-	2	-	5	0+1	-
	A/C Plant Room 空調機房	2	-	1	-	-	-	0+1	-
	Electrical Room 電錶房	2	-	1	-	-	-	2+0	-
	Filtration Plant Room 泳池濾水泵房	5	-	1	-	-	-	0+1	-
	Sprinkler Water Pump Room 消防花灑水泵房	3	-	1	-	-	-	0+1	-
	F.S. Pump Room 消防泵房	3	-	1	-	-	-	0+1	-
	Potable and Flushing Water Pump Room 食水及沖廁水泵房	5	-	1	-	-	-	0+1	-
Upper Ground Floor 地面高層	Kitchen 廚房	19	1	-	-	1	-	2+18	-
	Staircase 樓梯	10	1	-	-	-	-	0+0	-
	Living Room 客廳	23	1	-	-	-	-	1+7	-
	Dining Room 飯廳	13	1	-	-	-	-	0+3	-
	Store Room 儲物室	4	2	-	-	-	-	0+0	-
	Foyer 前廳	12	1	-	-	-	-	0+1	-
	Restroom in Store Room 儲物室內洗手間	2	-	-	-	1	-	0+0	-
	Restroom 洗手間	6	2	-	-	1	-	0+0	1
	Garden 花園	19	-	-	-	-	-	0+2	-
	Ensuite 1 套房 1	9	2	-	-	-	-	1+2	-
	Bathroom 1 浴室 1	5	-	-	-	1	-	0+1	1
	Dressing Room 衣帽間	3	2	-	-	-	-	0+0	1
	Library 書房	12	1	1	-	-	-	0+2	-
First Floor 一樓	Ensuite 2 套房 2	11	2	-	-	-	-	2+5	1
	Bathroom 2 浴室 2	4	-	-	-	1	-	0+1	1
	Ensuite 3 套房 3	11	2	-	-	-	-	2+3	1
	Bathroom 3 浴室 3	5	-	-	-	1	-	0+1	1
	Dressing Room 衣帽間	3	1	-	-	-	-	0+1	-
	Family Room 起居室	10	2	-	-	-	-	2+2	1
	Staircase 樓梯	9	1	-	-	-	-	0+0	1
	Master Ensuite 主人套房	28	2	-	-	-	-	2+4	1
	Master Bathroom 主人浴室	14	-	-	-	1	-	0+1	1
	Her Dressing Room 女主人衣帽間	6	2	-	-	-	-	0+4	1
	Restroom 洗手間	4	-	-	-	1	-	0+0	-
	His Dressing 男主人衣帽間	10	1	-	-	-	-	1+3	1
Corridor 走廊	12	-	-	-	-	-	0+2	-	
Roof Floor 天台	Roof 天台	6	-	-	-	-	-	3+0	-
	Staircase 樓梯	4	1	-	-	-	-	-	-
Top Roof Floor 頂層天台	Top Roof 頂層天台	1	-	-	-	-	-	-	

+ The above residential property is/was owned by Affluent Peak Limited. The shares of the holding company of the said company have been transferred and the said company has no longer been associated corporation of Wharf Peak Properties Limited. Information on the fittings, finishes and appliances of the above property set out in this sales brochure are based on the plans as at the date of the transfer.

+ 上述住宅物業由Affluent Peak Limited擁有。該公司的控權公司的股份已轉讓，該公司不再是Wharf Peak Properties Limited的有聯繫法團。本售樓說明書所載上述物業的裝置、裝修物料及設備乃以轉讓日期的圖則為準。

Schedule of Mechanical and Electrical Provisions - 機電裝置數量說明表

79 Peak Road 山頂道79號

Shaver Outlet 鬚刨 插座	TV/FM Outlet 電視/ 電台天 線插座	Tele- phone Outlet 電話 插座	Fiber Outlet 光纖 插座	M.C.B. Board 總電 掣箱	Touch Screen Display 智能觸 控屏幕	Towngas Water Heater Remote Controller 煤氣熱水爐 溫度控制	Towngas Water Heater 煤氣 熱水爐	Washing Machine Connection Point (Water Outlet) 洗衣機接駁點 (去水位)	Washing Machine Connection Point (Water Inlet) 洗衣機接駁點 (入水位)	Thermostat for A/C Indicator 空調溫度 控顯示器	VRV Indoor Unit and A/C Point VRV 分體空調室 內機位及其 接駁點	VRV Outdoor Unit and A/C Point VRV 分體空調室 外機位及其 接駁點
-	-	-	-	-	-	-	-	-	-	-	1	-
-	-	-	-	-	-	-	-	-	-	-	-	-
-	-	-	-	-	-	-	-	-	-	-	-	-
-	-	-	-	-	-	-	-	-	-	-	-	-
-	-	-	-	-	-	-	-	-	-	-	-	-
-	-	-	-	1	-	-	-	-	-	-	-	-
-	-	-	-	-	-	-	-	-	-	-	-	-
-	-	-	-	-	-	-	-	-	-	-	-	-
-	-	-	-	-	-	-	-	-	-	-	-	-
-	-	-	-	-	1	-	2	1	1	-	4	-
-	-	-	-	-	-	-	-	-	-	-	-	-
-	1	1	1	-	-	-	-	-	-	-	-	-
-	-	-	-	-	-	-	-	-	-	2	-	-
-	-	-	-	-	-	-	-	-	-	3	1	-
-	-	-	-	-	-	-	-	-	-	-	5	-
-	-	-	-	-	-	-	-	-	-	-	1	-
1	-	-	-	-	-	1	-	-	-	8	-	-
-	-	-	-	-	-	-	-	-	-	-	-	-
-	1	-	-	-	-	-	-	-	-	1	-	2
-	-	-	-	-	-	-	-	-	-	-	-	-
1	-	-	-	-	-	1	-	-	-	1	1	-
-	-	-	-	-	-	-	-	-	-	2	2	-
-	1	2	1	-	-	-	-	-	-	1	-	-
1	-	-	-	-	-	1	-	-	-	-	1	-
-	1	2	1	-	-	-	-	-	-	-	-	-
-	-	-	-	-	-	-	-	-	-	-	-	-
-	-	1	-	-	-	-	-	-	-	1	3	-
-	1	1	1	-	-	-	-	-	-	2	-	-
-	-	-	-	-	-	-	-	-	-	-	-	-
1	1	2	1	-	-	1	-	-	-	1	2	-
-	-	-	-	-	-	-	-	-	-	-	-	-
1	-	-	-	-	-	-	-	-	-	1	-	-
-	-	-	-	-	-	-	-	-	-	-	2	-
1	-	1	1	-	-	1	-	-	-	1	-	-
-	-	-	-	-	-	-	-	-	-	-	-	-
-	-	-	-	-	-	-	2	-	-	-	-	-
-	-	-	-	-	-	-	-	-	-	-	-	-
-	-	-	-	-	-	-	-	-	-	-	-	-

Schedule of Mechanical and Electrical Provisions - 機電裝置數量說明表

79A Peak Road 山頂道79A號[^]

Floor 樓層	Location 位置	Lighting Point 照明燈位	Home Automation Control Panel for Lighting 智能控制掣面供照明	Lighting Switch 燈掣	Electric Vehicle Charger 電動車充電器	Double Pole Switch For Exhaust Fan 抽氣扇電源掣	Infrared Occupancy Sensor for Lighting 紅外線傳感器供照明	13A Switched Socket Outlet (Twin+Single) 13安培帶掣插蘇(雙位+單位)	Thermostat for Under Floor Heater System 地暖系統溫度控顯示器
Lower Ground Floor 地下低層	Lobby 大堂	2	-	-	-	-	1	0+1	-
	Staircase 樓梯	2	1	-	-	-	-	-	-
	Corridor 走廊	5	-	1	-	-	-	-	-
	Carpark 停車場	13	-	-	2	-	4	0+1	-
	Electrical Room 電錶房	1	-	1	-	-	-	2+0	-
	Filtration Plant Room 泳池濾水泵房	2	-	1	-	-	-	0+1	-
	A/C Plant Room 空調機房	1	-	1	-	-	-	0+1	-
	Potable and Flushing Water Pump Room 食水及沖廁水泵房	2	-	1	-	-	-	0+1	-
	Sprinkler Water Pump Room 消防花灑水泵房	2	-	1	-	-	-	0+1	-
F.S Pump Room 消防泵房	3	-	1	-	-	-	0+1	-	
Ground Floor 地下	Kitchen 廚房	21	1	-	-	-	-	0+1	-
	Staircase 樓梯	6	-	-	-	-	-	-	-
	Living Room and Dining Room 客廳及飯廳	57	4	-	-	-	-	4+3	-
	Bathroom 浴室	5	-	-	-	-	-	-	-
	Store Room 儲物室	2	1	-	-	-	-	1+1	-
	Restroom 洗手間	1	-	-	-	-	-	-	-
	Study Room 書房	16	1	-	-	-	-	2+1	-
Garden 花園	3	-	-	-	-	-	2+0	-	
First Floor 一樓	Ensuite 1 套房 1	13	3	-	-	-	-	4+2	-
	Bathroom 1 浴室 1	4	-	-	-	-	-	-	-
	Ensuite 2 套房 2	18	3	-	-	-	-	4+2	-
	Bathroom 2 浴室 2	4	-	-	-	-	-	-	-
	Ensuite 3 套房 3	17	4	-	-	-	-	4+3	-
	Bathroom 3 浴室 3	4	-	-	-	-	-	-	-
	Ensuite 4 套房 4	14	3	-	-	-	-	3+2	-
	Bathroom 4 浴室 4	4	-	-	-	-	-	-	-
	Dressing Room 衣帽間	2	1	-	-	-	-	1+1	-
	Family Room 起居室	18	1	-	-	-	-	3+1	-
	Foyer 前廳	7	-	-	-	-	-	-	-
Staircase 樓梯	6	-	-	-	-	-	-	-	
Second Floor 二樓	Master Ensuite 主人套房	36	2	-	-	-	-	4+1	-
	Dressing Room in Master Ensuite 主人套房內衣帽間	9	2	-	-	-	-	2+2	-
	Her Bathroom 女主人浴室	9	-	-	-	-	-	-	-
	Foyer 前廳	4	1	-	-	-	-	0+1	-
	Ensuite 5 套房 5	15	3	-	-	-	-	4+2	-
	Bathroom 5 浴室5	4	-	-	-	-	-	-	-
	Staircase 樓梯	6	-	-	-	-	-	-	-
Flat Roof 平台	-	-	-	-	-	-	-	-	
Roof Floor 天台	Roof 天台	8	-	-	-	-	-	3+0	-
	Staircase 樓梯	-	-	-	-	-	-	-	-
Top Roof Floor 頂層天台	Top Roof 頂層天台	-	-	-	-	-	-	-	

[^] The above residential property is/was owned by Deluxe Achieve Limited. The shares of the holding company of the said company have been transferred and the said company has no longer been associated corporation of Wharf Peak Properties Limited. Information on the fittings, finishes and appliances of the above property set out in this sales brochure are based on the plans as at the date of the transfer.

[^] 上述住宅物業由Deluxe Achieve Limited擁有。該公司的控權公司的股份已轉讓，該公司不再是Wharf Peak Properties Limited的有聯繫法團。本售樓說明書所載上述物業的裝置、裝修物料及設備乃以轉讓日期的圖則為準。

Schedule of Mechanical and Electrical Provisions - 機電裝置數量說明表

79A Peak Road 山頂道79號A

Shaver Outlet 鬚刨插座	TV/FM Outlet 電視 / 電台天線插座	Telephone Outlet 電話插座	Fiber Outlet 光纖插座	M.C.B. Board 總電掣箱	Touch Screen Display 智能觸控屏幕	Towngas Water Heater Remote Controller 煤氣熱水爐溫度控制	Towngas Water Heater 煤氣熱水爐	Washing Machine Connection Point (Water Outlet) 洗衣機接駁點 (去水位)	Washing Machine Connection Point (Water Inlet) 洗衣機接駁點 (入水位)	Thermostat for A/C 空調溫度控制顯示器	VRV Indoor Unit and A/C Point VRV 分體空調室內機位及其接駁點	VRV Outdoor Unit and A/C Point VRV 分體空調室外機位及其接駁點
-	-	-	-	-	-	-	-	-	-	1	1	-
-	-	-	-	-	-	-	-	-	-	-	-	-
-	-	-	-	-	-	-	-	-	-	-	-	-
-	-	-	-	-	-	-	-	-	-	1	1	-
-	-	-	-	3	-	-	-	-	-	-	-	-
-	-	-	-	-	-	-	-	-	-	-	-	-
-	-	-	-	-	-	-	-	-	-	-	-	1
-	-	-	-	-	-	-	-	-	-	-	-	-
-	-	-	-	-	-	-	-	-	-	-	-	-
-	-	-	-	-	-	-	2	1	1	-	2	-
-	-	-	-	-	-	-	-	-	-	-	3	-
-	2	2	2	-	-	-	-	-	-	-	-	-
-	-	-	-	-	-	-	-	-	-	-	-	-
-	-	-	-	-	-	-	-	-	-	-	1	-
-	-	-	-	-	-	1	-	-	-	-	-	-
-	1	1	1	-	-	-	-	-	-	-	1	-
-	-	-	-	-	-	-	-	-	-	-	-	1
-	1	2	1	-	-	-	-	-	-	1	1	-
1	-	-	-	-	-	1	-	-	-	-	-	-
-	1	2	1	-	-	-	-	-	-	1	1	-
1	-	-	-	-	-	1	-	-	-	-	-	-
-	1	2	1	-	-	-	-	-	-	1	1	-
1	-	-	-	-	-	1	-	-	-	-	-	-
-	1	2	1	-	-	-	-	-	-	-	-	-
1	-	-	-	-	-	1	-	-	-	1	1	-
-	-	-	-	-	-	-	-	-	-	-	1	-
-	2	2	1	-	-	-	-	-	-	-	-	-
-	-	-	-	-	-	-	-	-	-	-	-	-
-	-	-	-	-	-	-	-	-	-	-	-	-
-	2	3	1	-	-	-	-	-	-	-	-	-
-	1	1	1	-	-	-	-	-	-	-	-	-
-	-	-	-	-	-	-	-	-	-	3	3	-
-	-	-	-	-	-	-	-	-	-	-	1	-
-	1	2	1	-	-	-	-	-	-	1	1	-
1	-	-	-	-	-	1	-	-	-	-	-	-
-	-	-	-	-	-	-	-	-	-	-	-	-
-	-	-	-	-	-	-	-	-	-	-	-	-
-	-	-	-	-	-	-	2	-	-	-	-	-
-	-	-	-	-	-	-	-	-	-	-	-	-
-	-	-	-	-	-	-	-	-	-	-	-	-

Schedule of Mechanical and Electrical Provisions - 機電裝置數量說明表

77A Peak Road 山頂道77A號

Floor 樓層	Location 位置	Lighting Point 照明 燈位	Home Automation Control Panel for Lighting 智能控制掣 面供照明	Lighting Switch 燈掣	Electric Vehicle Charger 電動車 充電器	Double Pole Switch For Exhaust Fan 抽氣扇 電源掣	Infrared Occupancy Sensor for Lighting 紅外線傳感 器供照明	13A Switched Socket Outlet (Twin+Single) 13安培 帶掣插蘇 (雙位+單位)	Thermostat for Under Floor Heater System 地暖系統溫 度控顯示器
Lower Ground Floor 地下 低層	Lobby 大堂	2	1	-	-	-	1	0+1	-
	Staircase 樓梯	2	-	-	-	-	-	0+0	-
	Corridor 走廊	4	-	-	-	-	-	0+0	-
	Carpark 停車場	3	-	-	2	-	3	0+1	-
	Electrical Room 電錶房	2	-	1	-	-	-	2+0	-
	Filtration Plant Room 泳池濾水泵房	4	-	1	-	-	-	0+1	-
	A/C Plant Room 空調機房	1	-	1	-	-	-	0+1	-
	Potable and Flushing Water Pump Room 食水及沖廁水泵房	4	-	1	-	-	-	0+2	-
Ground Floor 地下	F.S. and Sprinkler Water Pump Room 消防泵及消防花灑水泵房	3	-	1	-	-	-	0+2	-
	Kitchen 廚房	23	1	-	-	1	-	2+18	-
	Staircase 樓梯	4	1	-	-	-	-	0+1	1
	Living Room 客廳	15	1	-	-	-	-	2+1	-
	Dining Room 飯廳	12	1	-	-	-	-	2+0	-
	Restroom in Store Room 儲物室內洗手間	1	-	-	-	1	-	0+0	-
	Store Room 儲物室	4	2	-	-	-	-	1+2	-
	Entrance Lobby 大堂入口	11	-	-	-	-	-	0+0	-
	Restroom 洗手間	4	1	-	-	1	-	0+1	-
	Garden 花園	34	-	-	-	-	-	1+0	-
First Floor 一樓	Yard 庭院	-	-	-	-	-	-	1+1	-
	Ensuite 1 套房 1	13	3	-	-	-	-	4+2	1
	Bathroom 1 浴室 1	4	-	-	-	1	-	0+1	1
	Ensuite 2 套房 2	7	2	-	-	-	-	4+1	-
	Bathroom 2 浴室 2	4	-	-	-	1	-	0+1	1
	Ensuite 3 套房 3	11	2	-	-	-	-	4+1	1
	Bathroom 3 浴室 3	4	-	-	-	1	-	0+1	1
	Dressing Room 衣帽間	6	1	-	-	-	-	2+1	1
	Family Room 起居室	19	1	-	-	-	-	3+1	1
	Restroom 洗手間	2	-	-	-	1	-	0+0	1
Second Floor 二樓	Staircase 樓梯	4	1	-	-	-	-	0+1	1
	Study Room 書房	8	2	-	-	-	-	3+1	-
	Master Ensuite 主人套房	18	2	-	-	-	-	4+1	1
	Master Bathroom 主人浴室	16	-	-	-	1	-	2+1	2
	Her Dressing Room 女主人衣帽間	18	2	-	-	-	-	5+1	-
	His Dressing Room 男主人衣帽間	3	1	-	-	-	-	0+1	-
	Foyer 前廳	3	-	-	-	-	-	0+1	-
	Corridor 走廊	2	1	-	-	-	-	0+1	-
Flat Roof 平台	4	-	-	-	-	-	-	-	

Schedule of Mechanical and Electrical Provisions - 機電裝置數量說明表

77A Peak Road 山頂道77A號

Shaver Outlet 鬚刨 插座	TV/FM Outlet 電視/ 電台天 線插座	Tele- phone Outlet 電話 插座	Fiber Outlet 光纖 插座	M.C.B. Board 總電 掣箱	Touch Screen Display 智能觸 控屏幕	Towngas Water Heater Remote Controller 煤氣熱水爐 溫度控制	Towngas Water Heater 煤氣 熱水爐	Washing Machine Connection Point (Water Outlet) 洗衣機接駁點 (去水位)	Washing Machine Connection Point (Water Inlet) 洗衣機接駁點 (入水位)	Thermostat for A/C Indicator 空調溫度 控顯示器	VRV Indoor Unit and A/C Point VRV 分體空調室 內機位及其 接駁點	VRV Outdoor Unit and A/C Point VRV 分體空調室 外機位及其 接駁點
-	-	-	-	-	-	-	-	-	-	1	-	-
-	-	-	-	-	-	-	-	-	-	-	-	-
-	-	-	-	-	-	-	-	-	-	-	-	-
-	-	-	-	-	-	-	-	-	-	-	-	-
-	-	-	-	3	-	-	-	-	-	-	-	-
-	-	-	-	-	-	-	-	-	-	-	-	-
-	-	-	-	-	-	-	-	-	-	-	-	1
-	-	-	-	-	-	-	-	-	-	-	-	-
-	-	-	-	-	-	-	-	-	-	-	-	-
-	-	-	-	-	1	-	2	1	1	2	2	-
-	-	-	-	-	-	-	-	-	-	-	-	-
-	1	1	1	-	-	-	-	-	-	-	-	-
-	1	1	1	-	-	-	-	-	-	-	-	-
1	-	-	-	-	-	1	-	-	-	-	-	-
-	-	-	-	-	-	-	-	-	-	-	-	-
-	-	-	-	-	-	-	-	-	-	-	4	-
-	-	-	-	-	-	-	-	-	-	1	1	-
-	-	-	-	-	-	-	-	-	-	-	-	4
-	-	-	-	-	-	-	-	-	-	-	-	-
-	1	2	1	-	-	-	-	-	-	1	-	-
1	1	-	-	-	-	1	-	-	-	-	-	-
-	1	2	1	-	-	-	-	-	-	1	-	-
1	1	-	-	-	-	1	-	-	-	-	-	-
-	1	2	1	-	-	-	-	-	-	2	-	-
1	1	-	-	-	-	1	-	-	-	-	1	-
-	-	-	-	-	-	-	-	-	-	-	1	-
-	2	2	1	-	-	-	-	-	-	-	-	-
1	-	-	-	-	-	1	-	-	-	-	-	-
-	-	-	-	-	-	-	-	-	-	-	-	-
-	1	1	1	-	-	-	-	-	-	1	1	-
-	2	3	1	-	-	-	-	-	-	2	-	-
1	2	2	1	-	-	1	-	-	-	1	2	-
-	1	1	1	-	-	-	-	-	-	1	1	-
-	-	-	-	-	-	-	-	-	-	1	-	-
-	-	-	-	-	-	-	-	-	-	-	-	-
-	-	-	-	-	-	-	-	-	-	-	1	-
-	-	-	-	-	-	-	-	-	-	-	-	-
-	-	-	-	-	-	-	-	-	-	-	-	-

Schedule of Mechanical and Electrical Provisions - 機電裝置數量說明表

77B Peak Road 山頂道77B號

Floor 樓層	Location 位置	Lighting Point 照明 燈位	Lighting Switch 燈掣	Electric Vehicle Charger 電動車 充電器	Double Pole Switch For Exhaust Fan 抽氣扇 電源掣	Infrared Occupancy Sensor for Lighting 紅外線傳感器 供照明	13A Switched Socket Outlet (Twin+Single) 13安培 帶掣插蘇 (雙位+單位)	Thermostat for Under Floor Heater System 地暖系統溫 度控顯示器
Below Lower Ground Floor 低於 地下 低層	F.S. and Sprinkler Water Pump Room 消防泵房及消防花灑水泵房	4	2	-	-	-	0+1	-
Lower Ground Floor 地下 低層	Lobby 大堂	2	-	-	-	-	0+1	-
	Staircase 樓梯	2	-	-	-	-	-	-
	Corridor 走廊	2	-	-	-	-	-	-
	Carpark 停車場	30	-	2	-	3	0+2	-
	Electrical Room 電錶房	2	1	-	-	-	0+1	-
	Filtration Plant Room 泳池濾水泵房	4	1	-	-	-	0+1	-
	Potable and Flushing Water Pump Room 食水及沖廁水泵房	4	1	-	-	-	0+1	-
Ground Floor 地下	Kitchen 廚房	11	-	-	1	-	2+1	-
	Staircase 樓梯	7	-	-	-	-	0+1	-
	Living Room and Dining Room 客廳及飯廳	39	-	-	-	-	5+2	1
	Restroom 洗手間	1	-	-	1	-	0+0	-
	Garden 花園	13	-	-	-	-	0+2	-
First Floor 一樓	Ensuite 1 套房 1	9	-	-	-	-	3+1	1
	Bathroom 1 浴室 1	4	-	-	1	-	0+1	-
	Dressing Room 衣帽間	2	-	-	-	-	0+2	1
	Ensuite 2 套房 2	11	-	-	-	-	4+3	-
	Bathroom 2 浴室 2	4	-	-	1	-	0+1	1
	Ensuite 3 套房 3	11	-	-	-	-	4+3	1
	Bathroom 3 浴室 3	4	-	-	1	-	0+1	1
	Family Room 起居室	8	-	-	-	-	2+1	1
	Foyer 前廳	6	-	-	-	-	0+1	-
	Staircase 樓梯	6	-	-	-	-	-	-
	Store Room 儲物室	3	-	-	-	-	0+1	-
Bathroom 浴室	1	-	-	1	-	-	-	
Second Floor 二樓	Master Ensuite 主人套房	21	-	-	-	-	4+1	1
	Master Bathroom 主人浴室	12	-	-	1	-	0+2	1
	Dressing Room 衣帽間	18	-	-	-	-	3+2	1
	Foyer 前廳	3	-	-	-	-	-	-
	Staircase 樓梯	7	-	-	-	-	-	-
	Flat Roof 平台	0	-	-	-	-	-	-

Schedule of Mechanical and Electrical Provisions - 機電裝置數量說明表

77B Peak Road 山頂道77B號

Shaver Outlet 鬚刨 插座	TV/FM Outlet 電視/ 電台天 線插座	Tele- phone Outlet 電話 插座	Fiber Outlet 光纖 插座	M.C.B. Board 總電 掣箱	Touch Screen Display 智能觸 控屏幕	Towngas Water Heater Remote Controller 煤氣熱水爐 溫度控制	Towngas Water Heater 煤氣 熱水爐	Washing Machine Connection Point (Water Outlet) 洗衣機接駁點 (去水位)	Washing Machine Connection Point (Water Inlet) 洗衣機接駁點 (入水位)	Thermostat for A/C Indicator 空調溫度 控顯示器	VRV Indoor Unit and A/C Point VRV 分體空調室 內機位及其 接駁點	VRV Outdoor Unit and A/C Point VRV 分體空調室 外機位及其 接駁點
-	-	-	-	-	-	-	-	-	-	-	-	-
-	-	-	-	-	-	-	-	-	-	1	1	-
-	-	-	-	-	-	-	-	-	-	-	-	-
-	-	-	-	-	-	-	-	-	-	-	1	-
-	-	-	-	5	-	-	-	-	-	-	-	-
-	-	-	-	-	-	-	-	-	-	-	-	-
-	-	-	-	-	1	1	2	1	1	1	1	-
-	-	-	-	-	-	-	-	-	-	-	-	-
-	3	3	2	-	-	-	-	-	-	7	4	-
-	-	-	-	-	-	-	-	-	-	-	-	-
-	-	-	-	-	-	-	-	-	-	-	-	1
-	1	2	1	-	-	-	-	-	-	1	1	-
1	-	-	-	-	-	1	-	-	-	-	-	-
-	-	-	-	-	-	-	-	-	-	-	-	-
-	1	2	1	-	-	-	-	-	-	1	1	-
1	-	-	-	-	-	1	-	-	-	-	-	-
-	1	2	1	-	-	-	-	-	-	1	1	-
1	-	-	-	-	-	1	-	-	-	-	-	-
-	2	2	1	-	-	-	-	-	-	1	1	-
-	-	-	-	-	-	-	-	-	-	-	1	-
-	-	-	-	-	-	-	-	-	-	-	-	-
-	-	-	-	-	-	-	-	-	-	1	1	-
-	-	-	-	-	-	1	-	-	-	-	-	-
-	2	3	1	-	-	-	-	-	-	2	2	-
1	-	-	-	-	-	1	-	-	-	1	1	-
-	1	1	1	-	-	-	-	-	-	2	2	-
-	-	-	-	-	-	-	-	-	-	-	1	-
-	-	-	-	-	-	-	-	-	-	-	-	-
-	-	-	-	-	-	-	-	-	-	-	-	-

Schedule of Mechanical and Electrical Provisions - 機電裝置數量說明表

77C Peak Road 山頂道77C號

Floor 樓層	Location 位置	Lighting Point 照明 燈位	Home Automation Control Panel for Lighting 智能控制掣 面供照明	Lighting Switch 燈掣	Electric Vehicle Charger 電動車 充電器	Double Pole Switch For Exhaust Fan 抽氣扇 電源掣	Infrared Occupancy Sensor for Lighting 紅外線傳感 器供照明	13A Switched Socket Outlet (Twin+Single) 13安培 帶掣插蘇 (雙位+單位)	Thermostat for Under Floor Heater System 地暖系統溫 度控顯示器
Lower Ground Floor 地下 低層	Lobby 大堂	4	2	-	-	-	1	0+1	-
	Staircase 樓梯	4	-	-	-	-	-	-	-
	Corridor 走廊	4	-	-	-	-	-	-	-
	Carpark 停車場	25	-	-	2	-	3	0+2	-
	Electrical Room 電錶房	2	-	1	-	-	-	0+1	-
	Filtration Plant Room 泳池濾水泵房	5	-	1	-	1	-	0+1	-
	Flushing Water Pump Room 沖廁水泵房	4	-	1	-	1	-	0+1	-
	A/C Plant Room 空調機房	2	-	1	-	1	-	0+1	-
Ground Floor 地下	F.S and Sprinkler Water Pump Room 消防泵房及消防花灑水泵房	3	-	2	-	1	-	0+1	-
	Kitchen 廚房	12	1	-	-	-	-	2+0	-
	Staircase 樓梯	2	-	-	-	-	-	-	-
	Living Room 客廳	29	2	-	-	-	-	2+8	-
	Dining Room 飯廳	32	3	-	-	-	-	2+3	1
	Restroom 洗手間	5	1	1	-	-	-	-	-
	Potable Water Pump Room 食水泵房	4	-	1	-	1	-	0+1	-
	Garden 花園	10	-	-	-	-	-	0+2	-
First Floor 一樓	Ensuite 1 套房 1	17	1	-	-	-	-	4+3	1
	Bathroom 1 浴室 1	8	-	-	-	-	-	0+1	1
	Pantry 茶水間	4	2	-	-	-	-	0+1	-
	Ensuite 2 套房 2	20	4	-	-	-	-	5+3	1
	Bathroom 2 浴室 2	9	-	-	-	-	-	0+1	1
	Ensuite 3 套房 3	18	4	-	-	-	-	4+3	1
	Bathroom 3 浴室 3	9	-	-	-	-	-	0+1	1
	Foyer 前廳	4	2	-	-	-	-	0+1	1
	Staircase 樓梯	2	-	-	-	-	-	1+1	-
	Restroom 洗手間	4	2	-	-	-	-	3+3	1
Second Floor 二樓	Master Ensuite 主人套房	25	1	-	-	-	-	-	-
	Master Bathroom 主人浴室	17	-	-	-	-	-	0+1	1
	Dressing Room 衣帽間	15	-	-	-	-	-	3+5	1
	Foyer 前廳	4	1	-	-	-	-	0+1	1
	Staircase 樓梯	2	-	-	-	-	-	-	-

Schedule of Mechanical and Electrical Provisions - 機電裝置數量說明表

77C Peak Road 山頂道77C號

Shaver Outlet 鬚刨 插座	TV/FM Outlet 電視/ 電台天 線插座	Tele- phone Outlet 電話 插座	Fiber Outlet 光纖 插座	M.C.B. Board 總電 掣箱	Touch Screen Display 智能觸 控屏幕	Towngas Water Heater Remote Controller 煤氣熱水爐 溫度控制	Towngas Water Heater 煤氣 熱水爐	Washing Machine Connection Point (Water Outlet) 洗衣機接駁點 (去水位)	Washing Machine Connection Point (Water Inlet) 洗衣機接駁點 (入水位)	Thermostat for A/C Indicator 空調溫度 控顯示器	VRV Indoor Unit and A/C Point VRV 分體空調室 內機位及其 接駁點	VRV Outdoor Unit and A/C Point VRV 分體空調室 外機位及其 接駁點
-	-	-	-	-	-	-	-	-	-	1	1	-
-	-	-	-	-	-	-	-	-	-	-	-	-
-	-	-	-	-	-	-	-	-	-	-	-	-
-	-	-	-	-	-	-	-	-	-	-	1	-
-	-	-	-	5	-	-	-	-	-	-	-	-
-	-	-	-	-	-	-	-	-	-	-	-	-
-	-	-	-	-	-	-	-	-	-	-	-	-
-	-	-	-	-	-	-	-	-	-	-	-	-
-	-	-	-	-	-	-	-	-	-	-	-	-
-	-	-	-	-	1	1	2	1	1	1	1	-
-	-	-	-	-	-	-	-	-	-	-	-	-
-	2	2	1	-	-	-	-	-	-	-	2	-
-	-	-	-	-	-	-	-	-	-	7	2	-
-	-	-	-	-	-	-	-	-	-	-	-	-
-	-	-	-	-	-	-	-	-	-	-	-	-
-	-	-	-	-	-	-	-	-	-	-	-	1
-	1	1	1	-	-	-	-	-	-	2	2	-
1	-	-	-	-	-	1	-	-	-	-	-	-
-	-	-	-	-	-	-	-	-	-	-	-	-
-	1	4	2	-	-	-	-	-	-	1	1	-
1	-	-	-	-	-	1	-	-	-	-	-	-
-	1	2	1	-	-	-	-	-	-	1	1	-
1	-	-	-	-	-	1	-	-	-	-	-	-
-	-	-	-	-	-	-	-	-	-	-	-	-
-	-	-	-	-	-	-	-	-	-	-	-	-
-	1	2	1	-	-	1	-	-	-	1	1	-
-	-	-	-	-	-	-	-	-	-	2	2	-
1	-	-	-	-	-	1	-	-	-	1	1	-
-	1	1	1	-	-	-	-	-	-	2	2	-
-	-	-	-	-	-	-	-	-	-	-	-	-
-	-	-	-	-	-	-	-	-	-	-	-	-

Schedule of Mechanical and Electrical Provisions - 機電裝置數量說明表

77D Peak Road 山頂道77D號

Floor 樓層	Location 位置	Lighting Point 照明 燈位	Home Automation Control Panel for Lighting 智能控制掣 面供照明	Lighting Switch 燈掣	Electric Vehicle Charger 電動車 充電器	Double Pole Switch For Exhaust Fan 抽氣扇 電源掣	Infrared Occupancy Sensor for Lighting 紅外線傳感 器供照明	13A Switched Socket Outlet (Twin+Single) 13安培 帶掣插蘇 (雙位+單位)	Thermostat for Under Floor Heater System 地暖系統溫 度控顯示器
Lower Ground Floor 地下 低層	Lobby 大堂	5	1	-	-	-	1	0+1	-
	Staircase 樓梯	4	1	-	-	-	-	0+0	-
	Carpark 停車場	4	-	-	2	-	4	0+1	-
	Electrical Room 電錶房	2	-	1	-	-	-	2+1	-
	Filtration Plant Room 泳池濾水泵房	2	-	1	-	-	-	0+1	-
	Potable and Flushing Water Pump Room 食水及沖廁水泵房	4	-	1	-	-	-	0+0	-
	A/C Plant Room 空調機房	2	-	1	-	-	-	0+1	-
Ground Floor 地下	Kitchen 廚房	15	1	-	-	1	-	2+16	-
	Staircase 樓梯	2	-	-	-	-	-	0+0	-
	Living Room 客廳	18	2	-	-	-	-	3+1	-
	Dining Room 飯廳	12	-	-	-	-	-	0+1	-
	Bathroom 浴室	2	-	-	-	1	-	0+0	1
	Restroom in Store Room 儲物室內洗手間	1	-	-	-	1	-	0+0	-
	Store Room 儲物室	7	1	-	-	1	-	2+2	-
	Corridor 走廊	2	2	-	-	-	-	0+2	-
	F.S and Sprinkler Water Pump Room 消防泵及消防花灑水泵房	3	-	2	-	-	-	0+1	-
	Garden 花園	29	-	-	-	-	-	1+0	-
	Yard 庭院	-	-	-	-	-	-	0+1	-
First Floor 一樓	Ensuite 1 套房 1	12	2	-	-	-	-	4+1	-
	Bathroom 1 浴室 1	5	-	-	-	1	-	0+1	1
	Dressing Room 衣帽間	6	1	-	-	-	-	2+1	1
	Ensuite 2 套房 2	8	3	-	-	-	-	4+2	1
	Bathroom 2 浴室 2	4	-	-	-	1	-	0+1	1
	Ensuite 3 套房 3	8	3	-	-	-	-	4+2	-
	Bathroom 3 浴室 3	4	-	-	-	1	-	0+1	1
	Family Room 起居室	15	2	-	-	-	-	2+1	1
Staircase 樓梯	2	-	-	-	-	-	0+0	-	
Second Floor 二樓	Master Ensuite 主人套房	24	1	-	-	-	-	4+0	1
	Master Bathroom 主人浴室	8	-	-	-	1	-	0+0	1
	Dressing Room 衣帽間	18	3	-	-	-	-	3+2	-
	Foyer 前廳	3	1	-	-	-	-	0+0	1
	Staircase 樓梯	2	-	-	-	-	-	0+0	1
	Flat Roof 平台	-	-	-	-	-	-	0+0	-

Schedule of Mechanical and Electrical Provisions - 機電裝置數量說明表

77D Peak Road 山頂道77D號

Shaver Outlet 鬚刨 插座	TV/FM Outlet 電視/ 電台天 線插座	Tele- phone Outlet 電話 插座	Fiber Outlet 光纖 插座	M.C.B. Board 總電 掣箱	Touch Screen Display 智能觸 控屏幕	Towngas Water Heater Remote Controller 煤氣熱水爐 溫度控制	Towngas Water Heater 煤氣 熱水爐	Washing Machine Connection Point (Water Outlet) 洗衣機接駁點 (去水位)	Washing Machine Connection Point (Water Inlet) 洗衣機接駁點 (入水位)	Thermostat for A/C Indicator 空調溫度 控顯示器	VRV Indoor Unit and A/C Point VRV 分體空調室 內機位及其 接駁點	VRV Outdoor Unit and A/C Point VRV 分體空調室 外機位及其 接駁點
-	-	-	-	-	-	-	-	-	-	-	-	-
-	-	-	-	-	-	-	-	-	-	-	-	-
-	-	-	-	-	-	-	-	-	-	-	-	-
-	-	-	-	1	-	-	-	-	-	-	-	-
-	-	-	-	-	-	-	-	-	-	-	-	-
-	-	-	-	-	-	-	-	-	-	-	-	-
-	-	-	-	-	-	-	-	-	-	-	-	-
-	-	-	-	-	-	-	2	-	-	1	1	-
-	-	-	-	-	-	-	-	-	-	-	-	-
-	2	2	2	-	-	-	-	-	-	2	-	-
-	1	1	1	-	-	-	-	-	-	1	2	-
1	-	-	-	-	-	1	-	-	-	-	-	-
1	1	-	-	-	-	1	-	-	-	-	-	-
-	-	-	-	-	-	-	-	1	1	2	1	-
-	-	-	-	-	1	-	-	-	-	7	-	-
-	-	-	-	-	-	-	-	-	-	-	-	1
-	-	-	-	-	-	-	-	-	-	-	-	1
-	-	-	-	-	-	-	-	-	-	-	-	-
-	1	2	1	-	-	-	-	-	-	1	-	-
1	1	-	-	-	-	1	-	-	-	-	-	-
-	-	-	-	-	-	-	-	-	-	-	1	-
-	1	2	1	-	-	-	-	-	-	1	-	-
1	1	-	-	-	-	-	-	-	-	-	-	-
-	1	2	1	-	-	-	-	-	-	1	-	-
1	1	-	-	-	-	1	-	-	-	-	-	-
-	1	2	1	-	-	-	-	-	-	1	-	-
1	1	-	-	-	-	1	-	-	-	-	-	-
-	2	2	1	-	-	-	-	-	-	1	1	-
-	-	-	-	-	-	-	-	-	-	-	-	-
-	2	3	1	-	-	-	-	-	-	2	-	-
1	1	-	-	-	-	1	2	-	-	1	2	-
-	1	1	1	-	-	-	-	-	-	-	3	-
-	-	-	-	-	-	-	-	-	-	1	2	-
-	-	-	-	-	-	-	-	-	-	-	-	-
-	-	-	-	-	-	-	-	-	-	-	-	-

Schedule of Mechanical and Electrical Provisions - 機電裝置數量說明表

77E Peak Road 山頂道77E號

Floor 樓層	Location 位置	Lighting Point 照明 燈位	Home Automation Control Panel for Lighting 智能控制掣 面供照明	Lighting Switch 燈掣	Electric Vehicle Charger 電動車 充電器	Double Pole Switch For Exhaust Fan 抽氣扇 電源掣	Infrared Occupancy Sensor for Lighting 紅外線傳感 器供照明	13A Switched Socket Outlet (Twin+Single) 13安培 帶掣插蘇 (雙位+單位)	Thermostat for Under Floor Heater System 地暖系統溫 度控顯示器
Lower Ground Floor 地下 低層	Lobby 大堂	2	-	-	-	-	1	0+1	-
	Staircase 樓梯	4	1	-	-	-	-	-	-
	Corridor 走廊	7	-	1	-	-	-	-	-
	Carpark 停車場	17	-	-	2	-	5	0+1	-
	Electrical Room 電錶房	1	-	1	-	-	-	2+0	-
	Filtration Plant Room 泳池濾水泵房	3	-	1	-	-	-	0+1	-
	A/C Plant Room 空調機房	1	-	1	-	-	-	0+1	-
	Potable and Flushing Water Pump Room 食水及沖廁水泵房	2	-	1	-	-	-	0+1	-
	Sprinkler Water Pump Room 消防花灑水泵房	2	-	1	-	-	-	0+1	-
	F.S Pump Room 消防泵房	3	-	1	-	-	-	0+1	-
Ground Floor 地下	Kitchen 廚房	19	1	-	-	-	-	0+1	-
	Staircase 樓梯	6	-	-	-	-	-	-	-
	Living Room and Dining Room 客廳及飯廳	51	3	-	-	-	-	4+3	-
	Store Room 儲物室	3	1	-	-	-	-	1+1	-
	Restroom 儲物室	1	-	-	-	-	-	-	-
	Garden 花園	28	-	-	-	-	-	2+0	-
	Ensuite 1 套房 1	13	2	-	-	-	-	3+1	-
	Bathroom 1 浴室 1	4	-	-	-	-	-	-	-
First Floor 一樓	Ensuite 2 套房 2	15	3	-	-	-	-	5+2	-
	Bathroom 2 浴室 2	4	-	-	-	-	-	-	-
	Ensuite 3 套房 3	14	3	-	-	-	-	4+2	-
	Bathroom 3 浴室 3	4	-	-	-	-	-	-	-
	Dressing Room in Ensuite 3 套房3內衣帽間	2	1	-	-	-	-	2+1	-
	Ensuite 4 套房 4	17	3	-	-	-	-	4+2	-
	Bathroom 4 浴室 4	4	-	-	-	-	-	-	-
	Dressing Room in Ensuite 4 套房4內衣帽間	6	1	-	-	-	-	2+1	-
	Family Room 起居室	20	2	-	-	-	-	3+2	-
	Bathroom 浴室	4	-	-	-	-	-	-	-
	Foyer 前廳	6	1	-	-	-	-	0+1	-
Staircase 樓梯	6	-	-	-	-	-	-	-	
Second Floor 二樓	Master Ensuite 主人套房	20	2	-	-	-	-	4+1	-
	Master Bathroom 主人浴室	7	-	-	-	-	-	-	-
	Dressing Room 衣帽間	12	1	-	-	-	-	2+1	-
	Ensuite 5 套房 5	11	3	-	-	-	-	4+2	-
	Bathroom 5 浴室 5	4	-	-	-	-	-	-	-
	Foyer 前廳	4	1	-	-	-	-	0+1	-
	Staircase 樓梯	2	-	-	-	-	-	-	-
	Dressing Room 衣帽間	2	1	-	-	-	-	1+1	-
Flat Roof 平台	-	-	-	-	-	-	-	-	
Roof Floor 天台	Roof 天台	10	1	-	-	-	-	3+0	-

Schedule of Mechanical and Electrical Provisions - 機電裝置數量說明表

77E Peak Road 山頂道77E號

Shaver Outlet 鬚刨 插座	TV/FM Outlet 電視/ 電台天 線插座	Tele- phone Outlet 電話 插座	Fiber Outlet 光纖 插座	M.C.B. Board 總電 掣箱	Touch Screen Display 智能觸 控屏幕	Towngas Water Heater Remote Controller 煤氣熱水爐 溫度控制	Towngas Water Heater 煤氣 熱水爐	Washing Machine Connection Point (Water Outlet) 洗衣機接駁點 (去水位)	Washing Machine Connection Point (Water Inlet) 洗衣機接駁點 (入水位)	Thermostat for A/C Indicator 空調溫度 控顯示器	VRV Indoor Unit and A/C Point VRV 分體空調室 內機位及其 接駁點	VRV Outdoor Unit and A/C Point VRV 分體空調室 外機位及其 接駁點
-	-	-	-	-	-	-	-	-	-	1	1	-
-	-	-	-	-	-	-	-	-	-	-	-	-
-	-	-	-	-	-	-	-	-	-	-	-	-
-	-	-	-	-	-	-	-	-	-	-	1	-
-	-	-	-	3	-	-	-	-	-	-	-	-
-	-	-	-	-	-	-	-	-	-	-	-	-
-	-	-	-	-	-	-	-	-	-	-	-	1
-	-	-	-	-	-	-	-	-	-	-	-	-
-	-	-	-	-	-	-	-	-	-	-	-	-
-	-	-	-	-	-	-	2	1	1	-	1	-
-	-	-	-	-	-	-	-	-	-	-	-	-
-	2	2	2	-	-	-	-	-	-	7	4	-
-	-	-	-	-	-	1	-	-	-	2	1	-
-	-	-	-	-	-	-	-	-	-	-	-	-
-	-	-	-	-	-	-	-	-	-	1	1	-
-	1	2	1	-	-	-	-	-	-	-	-	-
1	-	-	-	-	-	1	-	-	-	1	1	-
-	1	2	1	-	-	-	-	-	-	-	-	-
1	-	-	-	-	-	1	-	-	-	1	1	-
-	1	2	1	-	-	-	-	-	-	-	-	-
1	-	-	-	-	-	1	-	-	-	1	1	-
-	-	-	-	-	-	-	-	-	-	2	2	-
-	1	2	1	-	-	-	-	-	-	-	-	-
1	-	-	-	-	-	1	-	-	-	1	1	-
-	-	-	-	-	-	-	-	-	-	2	2	-
-	2	2	1	-	-	-	-	-	-	-	-	-
1	-	-	-	-	-	1	-	-	-	-	1	-
-	-	-	-	-	-	-	-	-	-	-	-	2 (Planter)
-	-	-	-	-	-	-	-	-	-	3	3	-
-	2	3	1	-	-	-	-	-	-	1	1	-
1	-	-	-	-	-	1	-	-	-	1	1	-
-	1	1	1	-	-	-	-	-	-	1	1	-
-	1	2	1	-	-	-	-	-	-	-	-	-
1	-	-	-	-	-	1	-	-	-	-	1	-
-	-	-	-	-	-	-	-	-	-	-	-	2 (Planter)
-	-	-	-	-	-	-	-	-	-	-	-	-
-	-	-	-	-	-	-	-	-	-	-	-	-
-	-	-	-	-	-	-	-	-	-	-	-	-

Schedule of Mechanical and Electrical Provisions - 機電裝置數量說明表

77F Peak Road 山頂道77F號

Floor 樓層	Location 位置	Lighting Point 照明 燈位	Home Automation Control Panel for Lighting 智能控制掣 面供照明	Lighting Switch 燈掣	Electric Vehicle Charger 電動車 充電器	Double Pole Switch For Exhaust Fan 抽氣扇 電源掣	Infrared Occupancy Sensor for Lighting 紅外線傳感 器供照明	13A Switched Socket Outlet (Twin+Single) 13安培 帶掣插蘇 (雙位+單位)	Thermostat for Under Floor Heater System 地暖系統溫 度控顯示器
Electrical and Mechanical Floor 機電層	F.S and Sprinkler Pump Water Room 消防泵及消防花灑水泵房	3	-	1	-	-	-	0+1	-
Lower Ground Floor 地下 低層	Lobby 大堂	8	1	-	-	-	1	0+1	-
	Staircase 樓梯	4	-	-	-	-	-	0+0	-
	Carpark 停車場	5	-	-	2	-	5	0+1	-
	Electrical Room 電錶房	2	-	1	-	-	-	2+0	-
	Filtration Plant Room 泳池濾水泵房	4	-	1	-	-	-	0+1	-
	A/C Plant Room 空調機房	2	-	1	-	-	-	0+1	-
	Potable and Flushing Water Pump Room 食水及沖廁水泵房	4	-	1	-	-	-	0+1	-
Ground Floor 地下	Kitchen 廚房	12	1	-	-	1	-	1+16	-
	Staircase 樓梯	2	-	-	-	-	-	0+0	-
	Living Room 客廳	15	-	-	-	-	-	2+0	-
	Dining Room 飯廳	15	1	-	-	-	-	1+1	-
	Store Room 儲物室	2	1	-	-	-	-	1+0	-
	Restroom in Store Room 儲物室內洗手間	1	-	-	-	1	-	0+0	-
	Restroom 洗手間	3	1	-	-	1	-	0+1	1
	Ensuite 2 套房 2	11	2	-	-	-	-	4+1	1
	Bathroom 2 浴室 2	3	-	-	-	1	-	0+1	1
	Corridor 走廊	2	2	-	-	-	-	0+1	1
	Garden 花園	23	-	-	-	-	-	2+1	-
	Ensuite 1 套房 1	13	2	-	-	-	-	4+2	1
	Bathroom 1 浴室 1	4	-	-	-	1	-	0+1	1
First Floor 一樓	Ensuite 3 套房 3	8	3	-	-	-	-	4+2	-
	Bathroom 3 浴室 3	4	-	-	-	1	-	0+1	1
	Corridor 走廊	2	-	-	-	-	-	0+0	1
	Family Room 起居室	6	1	-	-	-	-	2+1	1
	Foyer 前廳	5	-	-	-	-	-	0+1	-
	Staircase 樓梯	2	-	-	-	-	-	0+0	1
	Master Ensuite 主人套房	43	2	-	-	1	-	8+2	2
	Master Bathroom 主人浴室	9	-	-	-	1	-	0+1	1
	Dressing Room 衣帽間	4	2	-	-	-	-	2+1	1
Roof Floor 天台	Roof 天台	-	-	-	-	-	-	3+0	-

Schedule of Mechanical and Electrical Provisions - 機電裝置數量說明表

77F Peak Road 山頂道77F號

Shaver Outlet 鬚刨 插座	TV/FM Outlet 電視/ 電台天 線插座	Tele- phone Outlet 電話 插座	Fiber Outlet 光纖 插座	M.C.B. Board 總電 掣箱	Touch Screen Display 智能觸 控屏幕	Towngas Water Heater Remote Controller 煤氣熱水爐 溫度控制	Towngas Water Heater 煤氣 熱水爐	Washing Machine Connection Point (Water Outlet) 洗衣機接駁點 (去水位)	Washing Machine Connection Point (Water Inlet) 洗衣機接駁點 (入水位)	Thermostat for A/C Indicator 空調溫度 控顯示器	VRV Indoor Unit and A/C Point VRV 分體空調室 內機位及其 接駁點	VRV Outdoor Unit and A/C Point VRV 分體空調室 外機位及其 接駁點
-	-	-	-	-	-	-	-	-	-	-	-	-
-	-	-	-	-	-	-	-	-	-	2	-	-
-	-	-	-	-	-	-	-	-	-	-	-	-
-	-	-	-	-	-	-	-	-	-	-	-	-
-	-	-	-	3	-	-	-	-	-	-	-	-
-	-	-	-	-	-	-	-	-	-	-	-	1
-	-	-	-	-	-	-	-	-	-	-	-	1
-	-	-	-	-	-	-	-	-	-	-	-	2
-	-	-	-	-	-	-	2	1	1	1	2	-
-	-	-	-	-	-	-	-	-	-	-	-	-
-	1	1	1	-	-	-	-	-	-	-	2	-
-	1	1	1	-	-	-	-	-	-	-	2	-
-	-	-	-	-	1	-	-	-	-	-	-	-
-	-	-	-	-	-	-	-	-	-	-	-	-
1	-	-	-	-	-	1	-	-	-	-	-	-
-	1	2	1	-	-	-	-	-	-	1	3	-
1	1	-	-	-	-	1	-	-	-	-	1	-
-	-	-	-	-	-	-	-	-	-	-	1	-
-	-	-	-	-	-	-	-	-	-	-	-	-
-	1	2	1	-	-	-	-	-	-	1	1	-
1	1	-	-	-	-	1	-	-	-	-	-	-
-	1	2	1	-	-	-	-	-	-	1	-	-
1	1	-	-	-	-	1	-	-	-	-	1	-
-	-	-	-	-	-	-	-	-	-	-	-	-
-	2	2	1	-	-	-	-	-	-	1	1	-
-	-	-	-	-	-	-	-	-	-	-	1	-
-	-	-	-	-	-	-	-	-	-	-	-	-
1	3	4	2	-	-	-	-	-	-	4	3	-
1	1	-	-	-	-	1	-	-	-	-	1	-
-	1	1	1	-	-	-	-	-	-	2	1	-
-	-	-	-	-	-	-	2	-	-	-	-	-

Potable and flushing water is supplied by Water Supplies Department.

Electricity is supplied by The Hongkong Electric Company Limited.

Towngas is supplied by The Hong Kong and China Gas Company Limited.

Communal TV is supplied by Hong Kong Cable Television Limited.

食水及沖廁水由水務署供應。

電力由香港電燈有限公司供應。

煤氣由香港中華煤氣有限公司供應。

公共電視由香港有線電視有限公司供應。

The owner is liable for the Government rent payable for the specified residential property up to and including the date of completion of the sale and purchase of that residential property.

擁有人有法律責任繳付指明住宅物業的地稅直至住宅物業買賣完成日(包括該日)為止。

On the delivery of the vacant possession of the residential property to the purchaser, the purchaser is liable to reimburse the owner for the deposits for water, electricity and gas.

在向買方交付住宅物業在空置情況下的管有權時，買方須負責向擁有人補還水、電力及氣體的按金。

Note:

On delivery, the purchaser is liable to pay to the Manager a debris removal fee, and where the owner has paid that debris removal fee, the purchaser shall reimburse the owner for the same.

附註：

在交付時，買方須向管理人支付清理廢料的費用，而如擁有人已支付清理廢料的費用，買方須向擁有人補還清理廢料的費用。

Defect liability warranty period for the residential property and the fittings, finishes and appliances as provided in the agreement for sale and purchase is within six (6) months from the date of completion of the sale and purchase.

按買賣合約規定，住宅物業及住宅物業內裝置、裝修物料及設備之欠妥之處的保養責任期為住宅物業之成交日期起計為期六(6)個月內。

- (1) The Land Grant requires the owners of the residential properties in the Development to maintain slopes at their own costs.
- (2) Clause No.(10)(a) of the Second Schedule to the Modification Letter dated 27 August 2010 and registered in the Land Registry by Memorial No.10083102330017 stipulates that:

“Where there is or has been any cutting away, removal or setting back of any land, or any building up or filling in or any slope treatment works of any kind whatsoever, whether with or without the prior written consent of the Director, either within the premises hereby expressed to be demised or on any Government land, which is or was done for the purpose of or in connection with the formation, levelling or development of the premises hereby expressed to be demised or any part thereof or any other works required to be done by the said Lessee under the covenants and conditions herein contained, or for any other purpose, the said Lessee shall at his own expense carry out and construct such slope treatment works, retaining walls or other support, protection drainage or ancillary or other works as shall or may then or at any time thereafter be necessary to protect and support such land within the premises hereby expressed to be demised and also any adjacent or adjoining Government or leased land and to obviate and prevent any falling away, landslip or subsidence occurring thereafter. The said Lessee shall at all times during the term hereby granted maintain at his own expense the said land, slope treatment works, retaining walls or other support, protection, drainage or ancillary or other works in good and substantial repair and condition to the satisfaction of the Director.”
- (3) Each of the residential owners is obliged to contribute towards the costs of the maintenance work.
- (4) The plan for the slopes, retaining walls and related structures (“Slopes and Retaining Walls”) constructed or to be constructed, within or outside the land on which the Development is situated is set out on this page.
- (5) Under the Deed of Mutual Covenant of the Development, the Manager shall have the owners’ authority to engage suitable qualified personnel to inspect, keep and maintain in good substantial repair and condition and carry out any necessary works in respect of the Slopes and Retaining Walls in compliance with the Land Grant and in accordance with the “Geoguide 5-Guide to Slope Maintenance” issued by the Geotechnical Engineering Office (as amended from time to time) and the Maintenance Manual and all other guidelines issued from time to time by the appropriate government department regarding the maintenance of slopes, retaining walls and related structures.

Notes:

1. The term “premises hereby expressed to be demised” means “the Lot” as referred to in the “Summary of Land Grant” section, unless otherwise specified.
2. The term “Director” means “the Director of Lands”, unless otherwise specified.
3. The term “said Lessee” means “the Grantee” as referred to in the “Summary of Land Grant” section, unless otherwise specified.

- (1) 批地文件規定，發展項目中的住宅物業的擁有人須自費維修斜坡。
- (2) 2010年8月27日以註冊摘要編號10083102330017登記於土地註冊處的修訂書附表2的批地條款第(10)(a)條規定：

「如任何土地(不論位於批出地段內或任何政府土地上)遭切去、拆除或重新設置，或倘若任何建造、填土或任何斜坡處理工程經進行，不論是否已經先行徵得署長的書面同意，凡是為構造、平整或發展批出地段或者當中任何部分、或者是為執行該承授人在此等條款下需要進行的其他工程，又或者為其他目的，該承授人須自費開展和建設可能需要的斜坡處理工程、擋土牆或其他承托、防護、排水或任何其他附屬工程，以確保批出地段或毗鄰批出地段的政府土地或租用土地的安全，及防止和避免其後出現山泥傾瀉或地陷的情況。該承授人須於批地年期內時刻自費維持批出地段、斜坡處理工程、擋土牆或其他承托、防護、排水或任何其他附屬工程於良好狀況，達致署長滿意。」
- (3) 每名住宅物業擁有人均須分擔維修工程的費用。
- (4) 本頁之圖則顯示已經或將會在發展項目所位於的土地之內或之外建造的坡、護土牆及有關構築物（「斜坡及護土牆」）。
- (5) 根據發展項目公契，管理人獲擁有人授權按批地文件、土力工程處印發的「岩土指南第五冊 - 斜坡維修指南」（以不時的修訂本為準）和斜坡保養手冊及有關政府部門不時發出有關保養斜坡，護土牆及相關構築物的指引，聘請適合及具資格的人員檢查、維持及維修斜坡及護土牆，使其處於良好修葺的狀況，並就其進行必需的工程。

備註：

1. 除非另有指明，「批出地段」一詞所指的是批地文件的摘要內「該地段」一詞。
2. 除非另有指明，「署長」一詞所指的是「地政總署署長」。
3. 除非另有指明，「該承授人」一詞所指的是批地文件內「承授人」一詞。



 Slopes and Retaining Walls
斜坡及護土牆

Scale: 0 10 20 Metres
比例：  (米)

Note:

This plan is for showing the location of the Slopes and Retaining Walls only. Other matters shown in this plan may not reflect their latest conditions.

備註：

此圖僅作顯示斜坡及護土牆的位置，圖中所示之其他事項未必能反映其最新狀況。

No application to the Government for a modification of the Land Grant for this Development is underway.

本發展項目現時並沒有向政府提出申請修訂批地文件。

- Under the Deed of Mutual Covenant and Management Agreement (the "DMC") in respect of the Development, the Owner of 79 Peak Road shall keep the void area above the entrance foyer within his House (which void area is coloured violet on the plan annexed to the DMC) as void area and shall be responsible for the control management and maintenance of such void area.

The following fire service installations or equipment ("FSI") is included in each house of the Development:-

- 1) Fire Hydrant/ Hose Reel System;
- 2) Automatic Sprinkler System;
- 3) Manual Fire Alarm and Automatic Fire Alarm System;
- 4) Portable Hand Operated Approved Appliances; and
- 5) Miscellaneous fire services equipment (fire damper, emergency lighting, directional sign and exit sign).

Pursuant to Regulation 8(b) of the Fire Service (Installations and Equipment) Regulations, Chapter 95B of the Laws of Hong Kong, the owner(s) of any FSI which is installed in any premises shall have such FSI inspected by a Registered Fire Service Installation Contractor (RFSIC) at least once in every 12 months.

- 按照發展項目公契規定，山頂道79號之業主須保持其獨立屋入口大堂置上之中空地方(該中空地方在公契附圖上以紫色顯示)中空及須負責該中空地方之控制管理及保養。

發展項目中每間獨立屋包含以下消防裝置及設備：-

- 1) 消防栓 / 消防喉轆系統；
- 2) 自動花灑系統；
- 3) 手控火警警報及自動火警警報系統；
- 4) 認可的人手操作手提器具；及
- 5) 其他消防設備 (防火閘、應急照明系統、方向指示牌及出口指示牌)。

根據香港法例第95B章《消防(裝置及設備)規例》第8(b)條，擁有裝置在任何處所內的任何消防裝置或設備的人須安排每12個月由一名註冊承辦商檢查該等消防裝置或設備至少一次。

賣方就發展項目指定的互聯網網站的網址

The address of the website designated by the Vendor for Development for the purposes of Part 2 of the Residential Properties (First-hand Sales) Ordinance: www.7779peakroad.com.hk

賣方為施行《一手住宅物業銷售條例》第2部而就發展項目指定的互聯網網站的網址：www.7779peakroad.com.hk

Breakdown of Gross Floor Area (GFA) Concessions Obtained for All Features 獲寬免總樓面面積的設施分項

Latest information on breakdown of GFA concessions as shown on the general building plans submitted to and approved by the Building Authority (BA) prior to the printing of the sales brochure is tabulated below. Information marked (#) may be based on information provided by the authorized person if the sales brochure is printed prior to submission of the final amendment plans to the BA. The breakdown of GFA concessions may be subject to further changes until final amendment plans are submitted to and approved by the BA prior to the issuance of the occupation permit for the Development.

於印製售樓說明書前呈交予並已獲建築事務監督批准的一般建築圖則上有關總樓面面積寬免的分項的最新資料，請見下表。如印製售樓說明書時尚未呈交最終修訂圖則予建築事務監督，則有(#)號的資料可以由認可人士提供的資料作為基礎。直至最終修訂圖則於發出佔用許可證前呈交予並獲建築事務監督批准前，以下分項資料仍可能有所修改。

		Area (m ²) 面積 (平方米)
Disregarded GFA under Building (Planning) Regulations 23(3)(b) 根據《建築物(規劃)條例》第23(3)(b)條不計算的總樓面面積		
1(#)	Carpark and loading/unloading area excluding public transport terminus 停車場及上落客貨地方(公共交通總站除外)	1420.312
2	Plant Rooms and Similar Services 機房及相類設施	
2.1	Mandatory feature or essential plant room, area of which is limited by respective Practice Notes for Authorized Persons, Registered Structural Engineers and Registered Geotechnical Engineers (PNAP) or regulation such as lift machine room, telecommunications and broadcasting (TBE) room, TBE room for access facilities for mobile services, rooftop telecommunications equipment room, intermediate telecommunications equipment room, refuse storage chamber, etc. 所佔面積受相關《認可人士、註冊結構工程師及註冊岩土工程師作業備考》(《作業備考》)或規例限制的強制性設施或必要機房，例如升降機機房、電訊及廣播設備室(訊播室)、為流動通訊接達設施而設的訊播室、天台電訊設備室、中層電訊設備室、垃圾房等	18.986
2.2 (#)	Mandatory feature or essential plant room, area of which is NOT limited by any PNAP or regulation such as room occupied solely by fire service installations (F.S.I) and equipment, meter room, transformer room, potable and flushing water tank, etc. 所佔面積不受任何《作業備考》或規例限制的強制性設施或必要機房，例如僅由消防裝置及設備佔用的房間、電錶房、電力變壓房、食水及鹹水缸等	540.481
2.3	Non-mandatory or non-essential plant room such as air-conditioning (A/C) plant room, air handling unit (AHU) room, etc. 非強制性或非必要機房，例如空調機房、送風櫃房等	28.945
Green Features under Joint Practice Notes 1 and 2 根據聯合作業備考第1和第2號提供的環保設施		
3	Balcony 露台	5.000
4	Wider common corridor and lift lobby 加闊的公用走廊及升降機大堂	Not Applicable 不適用
5	Communal sky garden 公用空中花園	Not Applicable 不適用
6	Acoustic fin 隔聲緒	Not Applicable 不適用
7	Wing wall, wind catcher and funnel 翼牆、捕風器及風斗	Not Applicable 不適用
8	Non-structural prefabricated external wall 非結構預製外牆	60.144
9	Utility platform 工作平台	Not Applicable 不適用
10	Noise barrier 隔音屏障	Not Applicable 不適用

Notes:

The above table is based on the requirements as stipulated in Practice Note for Authorized Persons, Registered Structural Engineers and Registered Geotechnical Engineers ADM-2 issued by the Buildings Department. The Buildings Department may revise such requirements from time to time as appropriate.

附註：

上述表格是根據屋宇署所發出的《認可人士、註冊結構工程師及註冊岩土工程師作業備考》ADM-2 規定的要求而制訂的。屋宇署會按實際需要不時更改有關要求。

申請建築物總樓面面積寬免的資料

		Area (m ²) 面積 (平方米)
Amenity Features 適意設施		
11	Caretaker's quarters, counter, office, store, guard room and lavatory for watchman and management staff and owners' corporation office 管理員宿舍、供保安人員和管理處員工使用的櫃位、辦事處、貯物室、警衛室和廁所、以及業主立案法團辦事處	4.978
12	Residential recreational facilities including void, plant room, swimming pool filtration plant room, covered walkway, etc. serving solely the recreational facilities 住戶康樂設施，包括僅供康樂設施使用的中空空間、機房、游泳池的濾水機房、有蓋人行道等	195.443
13	Covered landscaped and play area 有蓋園景區及遊樂場地	Not Applicable 不適用
14	Horizontal screen / covered walkway and trellis 橫向屏障 / 有蓋人行道及花棚	Not Applicable 不適用
15	Larger lift shaft 擴大升降機槽	Not Applicable 不適用
16	Chimney shaft 煙囪管道	Not Applicable 不適用
17	Other non-mandatory or non-essential plant room, such as boiler room, satellite master antenna television (SMATV) room 其他非強制性或非必要機房，例如鍋爐房、衛星電視共用天線房	122.511
18(#)	Pipe duct, air duct and vertical riser for mandatory feature or essential plant room 強制性設施或必要機房所需的管槽、氣槽及垂直立管	30.583
19	Pipe duct, air duct for non-mandatory or non-essential plant room 非強制性設施或非必要機房所需的管槽及氣槽	Not Applicable 不適用
20	Plant room, pipe duct, air duct for environmentally friendly system and feature 環保系統及設施所需的機房、管槽及氣槽	Not Applicable 不適用
21	Void in duplex domestic flat and house 複式住宅單位及洋房的中空空間	7.425
22	Sunshade and reflector 遮陽篷及反光罩	Not Applicable 不適用
23(#)	Projecting planters and minor projection such as A/C box, A/C platform, window cill and projecting window 伸出式花槽及小型伸出物，例如空調機箱、空調機平台、窗檻及伸出的窗台	Not Applicable 不適用
24	Other projection such as A/C box and A/C platform not covered in paragraph 3(b) and (c) of PNAP APP-19, and maintenance walkway 《作業備考》APP-19 第3(b)及(c)段沒有涵蓋的其他伸出物，如空調機箱及空調機平台，及維修通道	Not Applicable 不適用

Notes:

The above table is based on the requirements as stipulated in Practice Note for Authorized Persons, Registered Structural Engineers and Registered Geotechnical Engineers ADM-2 issued by the Buildings Department. The Buildings Department may revise such requirements from time to time as appropriate.

附註：

上述表格是根據屋宇署所發出的《認可人士、註冊結構工程師及註冊岩土工程師作業備考》ADM-2 規定的要求而制訂的。屋宇署會按實際需要不時更改有關要求。

		Area (m ²) 面積 (平方米)
Other Exempted Items 其他項目		
25(#)	Refuge floor including refuge floor cum sky garden 庇護層，包括庇護層兼空中花園	Not Applicable 不適用
26	Covered area under large projecting / overhanging feature 大型伸出 / 外懸設施下的有蓋地方	Not Applicable 不適用
27	Public transport terminus 公共交通總站	Not Applicable 不適用
28(#)	Party structure and common staircase 共用構築物及公用樓梯	Not Applicable 不適用
29(#)	Horizontal area of staircase, lift shaft and vertical duct solely serving floor accepted as not being accountable for GFA 僅供獲接納不計入總樓面面積的樓層使用的樓梯、升降機槽及垂直管道的水平面積	Not Applicable 不適用
30	Public passage 公眾通道	Not Applicable 不適用
31	Covered set back area 有蓋的後移部分	Not Applicable 不適用
Bonus GFA 額外總樓面面積		
32	Bonus GFA 額外總樓面面積	Not Applicable 不適用
Additional Green Features under Joint Practice Note (No. 8) 根據聯合作業備考 (第 8 號) 提供的額外環保設施		
33	Buildings adopting Modular Integrated Construction 採用「組裝合成」建築法的樓宇	Not Applicable 不適用

The Environmental Assessment of the Building and Information on the Estimated Energy Performance or Consumption for the Common Parts of the Development 有關建築物的環境評估及發展項目的公用部分的預計能量表現或消耗

The approved general building plans of this Development are not subject to the requirements stipulated in the Practice Note for Authorized Persons, Registered Structural Engineers and Registered Geotechnical Engineers APP-151 issued by the Building Authority. Environmental assessment and information on the estimated energy performance or consumption for the common parts of this Development were not required to be submitted to the Building Authority as a prerequisite for the granting of gross floor area concessions.

本發展項目的經批准一般建築圖則不受由建築事務監督發出的《認可人士、註冊結構工程師及註冊岩土工程師作業備考》APP-151 規定規限。本發展項目的環境評估及公用部分的預計能量表現或消耗的資料無須呈交建築事務監督，以作為批予總樓面面積寬免的先決條件。

Notes:

The above table is based on the requirements as stipulated in Practice Note for Authorized Persons, Registered Structural Engineers and Registered Geotechnical Engineers ADM-2 issued by the Buildings Department. The Buildings Department may revise such requirements from time to time as appropriate.

附註：

上述表格是根據屋宇署所發出的《認可人士、註冊結構工程師及註冊岩土工程師作業備考》ADM-2 規定的要求而制訂的。屋宇署會按實際需要不時更改有關要求。

There may be future changes to the Development and the surrounding areas.

發展項目及其周邊地區日後可能出現改變。

Date of Printing of Sales Brochure: 15 January 2021

售樓說明書印製日期：2021年1月15日

EXAMINATION RECORD

檢視記錄

Examination / Revision Date 檢視 / 修改日期	Page Number 頁次	Revision Made 所作修改
5 March 2021 2021年3月5日	15	Location Plan of the Development is updated 更新發展項目的所在位置圖
	23, 29, 42, 43, 46, 50, 51	Floor Plans of Residential Properties in the Development are updated 更新發展項目的住宅物業的樓面平面圖
	98-99, 101-102, 104-105, 109, 112-113, 115, 117, 117A (Additional page 加頁), 118- 119, 121, 123-125, 127-129, 140-141, 156-157	Fittings, Finishes and Appliances are updated 更新裝置、裝修物料及設備
4 June 2021 2021年6月4日	15	Location Plan of the Development is updated 更新發展項目的所在位置圖
	16-19	Aerial Photograph of the Development are updated 更新發展項目的鳥瞰照片
	22, 41	Floor Plans of Residential Properties in the Development are updated 更新發展項目的住宅物業的樓面平面圖
2 September 2021 2021年9月2日	1-4, 4A (Additional page 加頁), 5-8	Notes to Purchasers of First-Hand Residential Properties is updated 更新一手住宅物業買家須知
	15	Location Plan of the Development is updated 更新發展項目的所在位置圖
	16-19	Aerial Photograph of the Development is updated 更新發展項目的鳥瞰照片
1 December 2021 2021年12月1日	15	Location Plan of the Development is updated 更新發展項目的所在位置圖
24 February 2022 2022年2月24日	15	Location Plan of the Development is updated 更新發展項目的所在位置圖
23 May 2022 2022年5月23日	15	Location Plan of the Development is updated 更新發展項目的所在位置圖
22 August 2022 2022年8月22日	3-4, 4A	Notes to Purchasers of First-Hand Residential Properties is updated 更新一手住宅物業買家須知
	10	Information on Vendor and Others Involved in the Development is updated 更新賣方及有參與發展項目的其他人的資料
	15	Location Plan of the Development is updated 更新發展項目的所在位置圖

EXAMINATION RECORD

檢視記錄

Examination / Revision Date 檢視 / 修改日期	Page Number 頁次	Revision Made 所作修改
17 November 2022 2022年11月17日	15	Location Plan of the Development is updated 更新發展項目的所在位置圖
	16-19	Aerial Photograph of the Development are updated 更新發展項目的鳥瞰照片
	21	Layout Plan of the Development is updated 更新發展項目的佈局圖
	33-36, 42-43	Floor Plans of Residential Properties in the Development are updated 更新發展項目的住宅物業的樓面平面圖
	59, 60	Floor Plans of Parking Spaces in the Development are updated 更新發展項目的中的停車位的樓平面圖
	84	Information on Public Facilities and Public Open Space is updated 更新公共設施及公眾休憩用地資料
15 February 2023 2023年2月15日	15	Location Plan of the Development is updated 更新發展項目的所在位置圖
11 May 2023 2023年5月11日	4A, 8	Notes to Purchasers of First-Hand Residential Properties are updated 更新一手住宅物業買家須知
	15	Location Plan of the Development is updated 更新發展項目的所在位置圖
	19A, 19B (Additional pages 加頁)	Aerial Photographs of the Development are added 新增發展項目的鳥瞰照片
10 August 2023 2023年8月10日	15	Location Plan of the Development is updated 更新發展項目的所在位置圖
8 November 2023 2023年11月8日	15	Location Plan of the Development is updated 更新發展項目的所在位置圖
	16-19B	Aerial Photographs of the Development are updated 更新發展項目的鳥瞰照片
	168-170	Information in Application for Concession on Gross Floor Area of Building are revised 修改申請建築物總樓面面積寬免的資料
7 February 2024 2024年2月7日	15	Location Plan of the Development is updated 更新發展項目的所在位置圖
	16-19	Aerial Photographs of the Development are updated 更新發展項目的鳥瞰照片
	19A, 19B	Aerial Photographs of the Development are deleted 刪除發展項目的鳥瞰照片

EXAMINATION RECORD

檢視記錄

Examination / Revision Date 檢視 / 修改日期	Page Number 頁次	Revision Made 所作修改
6 May 2024 2024年5月6日	15	Location Plan of the Development is updated 更新發展項目的所在位置圖
	16-17	Aerial Photograph of the Development is updated 更新發展項目的鳥瞰照片
31 July 2024 2024年7月31日	10	Information on Vendor and others Involved in the Development is updated 更新賣方及有參與發展項目的其他人的資料
	15	Location Plan of the Development is updated 更新發展項目的所在位置圖
	24, 28	Floor Plans of Residential Properties in the Development are updated 更新發展項目的住宅物業的樓面平面圖
	94-96, 103, 107, 130-132, 134, 148, 150	Fittings, Finishes and Appliances are updated 更新裝置、裝修物料及設備
30 October 2024 2024年10月30日	15	Location Plan of the Development is updated 更新發展項目的所在位置圖
	18-19	Aerial Photographs of the Development are updated 更新發展項目的鳥瞰照片
23 January 2025 2025年1月23日	10	Information on Vendor and others Involved in the Development is updated 更新賣方及有參與發展項目的其他人的資料
	15	Location Plan of the Development is updated 更新發展項目的所在位置圖
	168-169	Information in Application for Concession on Gross Floor Area of Building are revised 修改申請建築物總樓面面積寬免的資料

